

Training Science and Mathematics Teachers from High School to University

A GIANT EXPERIMENT AT
THE TALENT DEVELOPMENT CENTER

M. S. Hegde

INDIAN INSTITUTE OF SCIENCE



Foreword

The Indian Institute of Science (IISc) was formally born on May 27, 1909, when the then Government of India issued a Vesting Order. Nearly a century later in 2007, as the Centenary Year appeared imminent, faculty, alumni and many well-wishers of the institution began to discuss new initiatives that might propel the IISc forward into its second century. Over a hundred years, the Institute had expanded considerably in size and scope. The sylvan, Bangalore campus was beginning to appear crowded. While its famed greenery and naturally unkempt beauty were still evident, it was clear that future expansion, which appeared inevitable, would require a new campus. By the first decade of the 21st century large tracts of land in Bangalore were clearly unavailable and IISc began the process of looking farther afield. Several suggestions were forthcoming from the state government. As the momentum for a grand Centenary celebration increased, so too did the pressures for making a decision on the siting of the new campus. The die was cast on December 3, 2008 when the Chief Minister of Karnataka, Shri B.S.Yediyurappa, announced publicly, at the formal inauguration of the Centenary Celebrations by the then Prime Minister Dr.Manmohan Singh, that the State Government would grant land to the Institute once the choice was made from

possible locations. Kolar was amongst the possible locations. It was here that the District Commissioner pointed in the direction of Chitradurga, where we encountered a remarkably friendly and dynamic District commissioner, Amlan Biswas, who had already facilitated the entry of the Defence Research and Development Organisation (DRDO). He was also in discussions with the Department of Atomic Energy(DAE). If IISc was also to enter Chitradurga District the contours of a Science City would begin to form. On January 8, 2009, a group of about 30 faculty and administrators from the institute set out on a day long expedition, by bus, to Chitradurga to see the land that was available. While memory fades with time, I still recall what appeared to be a marvellous picnic, setting out early in the morning and reaching Chitradurga in time for discussions, lunch and inspections of the land. It was a beautiful day, when we stood with Amlan Biswas and his colleague the Superintendent of Police, Labhu Ram, looking out on the vast, dry tract of land in Challakere, I realised that as a completely city bred individual, I had never seen the horizon so clearly all around me. We were in the middle of nowhere. The absence of large trees exaggerated the feeling of openness. Imagination could have a free reign. In our wandering we came upon an abandoned group of shed like structures, remnants of an Australian

Sheep farm set up in the 1970s. Closer inspection revealed a couple of 'classrooms' with long abandoned benches, which had undoubtedly seen better days. A little farther away was a group of small houses, which appeared almost habitable, if renovated. These structures were on land which Amlan Biswas imagined would one day become the common area of a town, that would grow in time. He was encouraging, suggesting that the Institute might be able to lease the structures for its initial activities. Here was a beachhead which, if secured, could form the staging point from which IISc would build, over the next several years, its new campus. The warm reception of the district administration and their eagerness to develop the district made a deep impression. Amlan Biswas', grand vision of a Science City was infectious. As the one on whom the decision finally rested, I succumbed to Challakere. On the ride back to Bangalore, tired after a long day, we received a warm send off at Hiriyyur, where we were plied with papayas and chikku, local produce, which removed any misgivings in my mind about embarking on the Challakere adventure. In the bus some ideas began to form. Could we use the buildings we had just seen to start a program of teaching? Could we set up a centre where workshops and specialised courses were conducted in a secluded location, permitting

intense interactions between participants, which were rarely possible in Bangalore with its myriad diversions. Was there a possibility of interacting with the State Government to set up programs that would benefit education in Karnataka? In the days that followed, in 2009, some of these ideas and others were discussed by many colleagues at the Institute. The celebrations of the Centenary Year concluded on May 27, 2009. When the dust had settled, it was time to worry about the formal acquisition of the land in Challakere. Providence always plays a role. On my way back from a trip to Gulbarga, while settling into my berth on the train, a friendly passenger, H.S.Jagadeesh, entered and offered me cucumbers, which he assured me were special. I found out that he was at a loose end having just retired from an administrative position and was interested in any opportunity to work. A few days later he met me in my office. Not long after, in November 2009, he joined as a Special Officer with the responsibility of taking the Challakere project forward. Events moved quickly thereafter. The formalities for acquisition were complete by August 2010. Meanwhile, the buildings of the sheep farm and the proximal houses were taken on lease and renovated with the help of the Nirmiti Kendra, working under the district administration. In a fortunate coincidence, the Member of

Parliament elected to the Lok Sabha, in May 2009, from the Chitradurga constituency, Janardhana Swamy, happened to be an alumnus of the Institute, having obtained a Masters degree in Electrical Communication Engineering (1992-94).

I went back in August 2010 to find that we were indeed well positioned to begin some academic activity, even as the larger campus began to take shape. 2010 was a busy year. At the Institute, we were engaged in intense discussions on the proposal to begin an undergraduate program in science, a significant departure from the century long focus on research and postgraduate education. The Dean of the Science Faculty, M.S.Hegde, would meet me often. After our business was complete, we would begin to talk about other subjects. One day he mentioned he would be retiring formally in July 2010. The seeds of an idea that had been germinating in my mind for some time suddenly sprouted. Would he be interested in taking up the formidable task of establishing an academic program at Challakere, I asked. He not only welcomed the idea but quickly returned with many ideas of his own. Training science teachers using a completely hands on experimental approach was his first suggestion. I did have apprehensions about how everything he imagined would be accomplished

in our temporary site in Challakere, but his unbounded enthusiasm and extraordinarily optimistic approach was impossible to counter. Here was an idea that would undoubtedly benefit the school education system in Karnataka, the state that has been home to the Institute for a century. Very few people, and indeed almost no one living in the comfort of the Institute's Bangalore campus would have volunteered to pioneer such an activity in Challakere. This book is Hegde's account of nearly a decade of experience in the Teachers Training program at Challakere, a forerunner of what has now become an important National Mission. It is a tribute to all those who have helped Hegde achieve his vision and a valuable record of lessons learnt. Even as the new buildings have come up and the Training Program moves to modern surroundings on the new campus, this book will remind us of the early days of what will, hopefully, be an evolving activity at the Institute. Hegde's successors will have a hard act to follow.

P. Balaram



The group of IISc faculty at Challakere on January 8, 2009. In the centre (file in hand) Amlan Biswas, Deputy Commissioner, Chitradurga. To his left, Labhu Ram, Superintendent of Police. Front row, extreme left M.S.Hegde (photo credit: M.R.Chandrashekar)



On a post retirement visit to Challakere in 2016. H.S.Jagadeesh (extreme left) M.S.Hegde (blue shirt) and B.N.Raghunandan (extreme right), who has overseen the development of the IISc campus over the past several years. (photo credit: H.S.Jagadeesh)



preface

This book is the result of a giant experiment on training science and mathematics teachers from high school to university. Historically, a need for teachers' training to learn science was felt in Indian Institute of Science (IISc) in the early years of 1980. A group of committed professors went to schools nearby IISc, Bangalore and taught science to the teachers. This was later extended to district centres in collaboration with Department of State Education Research and Training (DSERT), Karnataka till 2009. IISc acquired a second campus at Challakere in 2009. A permanent facility to train teachers

at all levels of learning was conceived, and IISc decided to start the program in the leased facilities of a sheep-breeding farm adjacent to the IISc second campus. The dilapidated sheep-breeding farm had sufficient space for training as well as buildings for housing teachers. The government gave funds to refurbish it. Finally, on 26 February 2011, the Talent Development Centre (TDC) to train teachers at all levels got started.

An understanding on the education system in India; how systematically children receive education from school to university; a learning cycle; importance of science education; four levels of learning science from SSLC, preuniversity, BSc and MSc; issues related to Science Education vis-à-vis Engineering Education; and need for raising the level of learning science were introduced in the first chapter. A proposal why IISc should get involved to teach and train science teachers is argued based on the strength of IISc, and the goal of TDC is defined in chapter 1.

In the second chapter, how the sheep-breeding farm at Khudapura, Challakere got converted into TDC to run the teachers' training program is described to keep a record of how a good idea can be fructified if there is a will.

Training teachers is limited to the high school teachers acquiring a BEd degree. Minimum qualification of BSc + BEd is fixed to become a high school teacher. The teacher so appointed is assumed to have full knowledge against the actual fact. An in-depth analysis of inadequacy of teachers' knowledge and a need for a content enrichment training is presented in chapter 3.

In chapter 4, issues related to lower level of learning in the high school system are identified. How to overcome the difficulties faced by the teachers is addressed. Broad guidelines on training teachers by adopting the central theme of the book "Learn Science by Doing Experiments and Learn Mathematics by Solving Problems" are implemented with the experiments and training methods developed by the TDC. A novel idea of conducting tests

for the teachers on how much they knew, what they need to know and how much they gained from the training is described in this book. Also, how high school science teachers' training is conducted is described in this book. Typical experiences of teachers in terms of their performances are presented. High school teachers on average who scored about 20% marks on a good SSLC paper before they started their training, have scored more than 80% in 10 days. How the training is able to make the teachers accomplish so much in a short period of 10 days is the highlight of this chapter.

It is not sufficient if the teachers gained knowledge just to teach. How they have transferred their knowledge to the students after they went back to schools was the real question needed to be answered. SSLC results of the students of those schools from where the teachers came for training and also the teachers who did not undergo the training from the same schools were analysed taking 2015 as the base year. Analysis showed that the training helped the teachers to make the students score more marks in science and mathematics. Over 60% of mathematics teachers and 72% of science teachers were successful to make at least 30% of students score more than 60% marks in respective subjects in 2019. In 1855 schools, increase in the number of students scoring more

than 60% marks was as high as 50%. Additional number of students getting more than 60% in the science paper was about 20,000. Percentage of students scoring more than 70% marks in science and mathematics was doubled from 20% to 40%. The method of analysis and the impact of TDC-trained teachers on how much and how many students have gained is presented in chapter 5.

In chapter 6, extending the training method from high school teachers to PU college teachers is described. Experiments and the methods to train PU-PG teachers in physics, chemistry, biology and mathematics (PCBM) separately were developed. Successful experiment, "Learn science by doing experiments" covering over 85% of the subjects from NCERT books, by PU teachers are presented in this chapter.

In chapter 7, issues related to science education in degree colleges are discussed first. Experience gained in training the high school and PU college teachers was extended for training BSc degree college teachers. Experiences and measures of success achieved are also described.

MSc teachers' training in PCMB was the last one we had to deal with. Shortcomings of UGC refresher courses were taken into account and how TDC came

up with MSc teachers get trained in the core subjects is described in chapter 8.

In chapter 9, difficulties encountered in innovation, design, development, multiplication of experiments, issues related to equipping the schools and colleges are documented.

In chapter 10, the success achieved in training high school to MSc teachers is placed on record. It is shown that the experiment at TDC to train teachers at four levels can be adopted to scale-up for India. How to scale-up and train one lakh science teachers in a year to benefit 1 crore students per year, is proposed. In 10 years, almost all the science teachers would become competent in India if the governments accept the proposal.

In the last chapter 11, we briefly present how the knowledge gained in TDC can be effectively utilized to implement Teachers Education proposed in the new education policy, MHRD, Govt. of India 2020.

In the appendices A, B and C, we have given short write-ups of experiments teachers do in high school teachers' training, PU and BSc degree college teachers' training at the TDC, respectively. Development of new experiments has been the most important work of TDC. Experiments for high school, translate complete syllabus of 8th, 9th and 10th class

NCERT text books and more. Over 85 experiments, each in physics, chemistry and biology covers over 85% of PU text books. Over 100 BSc experiments, each in physics, chemistry and biology covers almost full syllabus. The book is not a prescription for how to train teachers. It is the idea how to learn science and how to enrich teachers' knowledge. As of 2019 December, over 9000 high school, 3500 PU college, 300 BSc degree college and 200 MSc level teachers have been trained in physics, chemistry, mathematics and biology (PCMB) covering the entire subjects they need to teach. Actual results and experiences of training, validity of methods used, consistency, reproducibility and acceptability by the teachers are described in this book. Based on the experiences and success achieved, the method of training is validated. Hope the work done at TDC will generate discussion and be noticed for expansion to benefit less fortunate science students of India.

M. S. Hegde

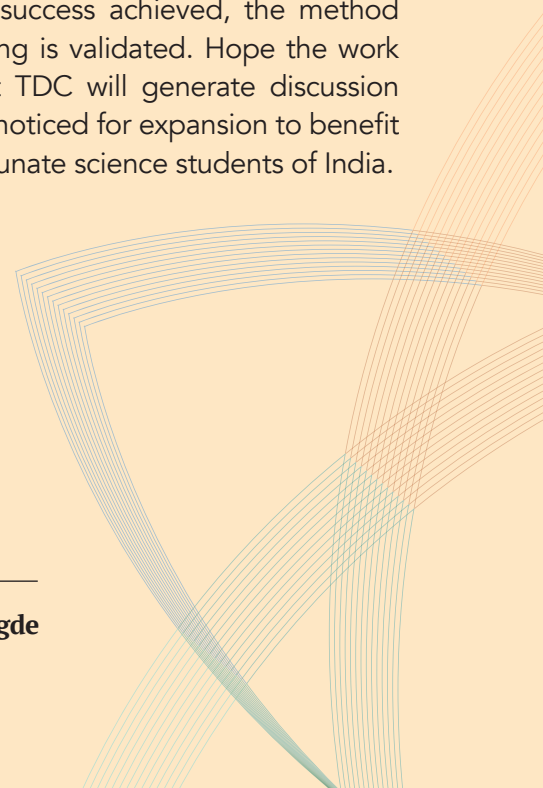

acknowledgement

The book is a result of work of all those associated with the A Giant Experiment at TDC (TDC).

In fact, I am only presenting their work. I am grateful to all of them because they have allowed me to present such a document on their behalf.

Professor Rangarajan, Director has been helpful to get grants under CSR to TDC and SDC. As soon as he took over the as the Director, he visited TDC and promised all the support to take forward the idea of teachers training at all levels.

Prof Anurag Kumar, former Director IISc has provided total support to run TDC. He was responsible to bring 8 mbps internet to the centre in 2010 itself before TDC was started. It was upgraded to 24 mbps.

The idea of teachers' training and support came from Prof P Balaram, Director of IISc in 2009. Subsequently, he gave me an opportunity to work for the Institute after my formal retirement in 2010. He has been a constant mentor to develop training programs. He appointed Prof Raghunandan to head Challakere Empowers Committee who gave unconditional support all along. These two men have guided the destiny of the new campus.

In-house faculty members of TDC have developed most part of the training program. Physics teaching and experiments have been developed by Dr Jugeshwar Singh, Coordinator of Physics. The success of TDC training is largely due to the unique method of teaching physics to CBZ high school teachers. His commitment to train teachers via experiments is truly remarkable. Prof CR Praneshachar and Prof J Venkatachala, coordinators of mathematics, who have been organising Mathematics Olympiad for India from HBCSE, have been the back bone of Mathematics program. They were part of high school teachers' training from the beginning. Prof M Urs, coordinator of mathematics, is a highly talented and passionate mathematics teacher for training other teachers. Of late Dr Malati Hegde, coordinator of mathematics, did enormous amount of work on how to make teachers learn by solving problems in mathematics at

all levels, especially the weaker ones. Prof Shishupala of Davangere University shouldered the responsibility of organising biology program initially. Dr S Aravinda joined as a biology coordinator and he has made the biology laboratory, an excellent place to learn biology. Without the total commitment of all these colleagues, it was highly impossible to organise such a large training program. I am truly grateful to all of them. I have been looking after chemistry and have developed the chemistry laboratory and the courses. Dr Kishore Kumar has been a great help instructing physics experiments. His dedication to TDC helped teachers learn a lot about physics. Dr Ragahavendra was the counterpart of Kishore in biology.

Professors P Kondaiah, Upendra Nongthomba, Depak Saini, G Shivakumar Swamy, D Narasimha Rao, C Durga Rao, Utpal Tatu, Siddharth P Sarma, Hema Balaram, MRN Murthy, R Manjunath, HA Ranganath, A Jagannadha Rao, HL Bhat, MK Raghavendra, V Venkatraman, Subhro Bhattacharjee, HR Krishnamurthy, Tarun Deep Saini, Arvind Ayyer, Arindam Gosh, Tanmoy Das, Sumilan Banerjee, Aveek Bid, Subroto Mukerjee, Manish Jain, Kaushal Verma, Vijay B Shenoy, KP Ramesh, PS Anil Kumar, S Kasthuriangan, Perna Sharma, Sathya Krishna, Vithal Rao, KR Srikantaiah, AK Nandakumaran, Vikramjeet Singh Chandel, PS Datti,

Koushik Ramachandran, Venky Krishnan, Vasudevamurthy, Manjunath Krishnapure, Vamsi Pritham, Thirupati Gudi, Harish Sheshadri, N Munichandraiah, S Sampath, KR Prabhu, A Srinivasan, AG Samuelson, Umesh V Waghmare, Balaji R Jagirdar, Michael Rajamathi, Abdul Khadar, Vasudev Bhat, GS Ramesh, Rajeev Ranjan and GV Anand have consistently come and gave lectures and supported the teaching program. I am grateful for their support. Many more have come and gave special lectures and made the teachers happy. We acknowledge all of them.

A large number of project assistants worked as instructors teaching how to do experiments and design a number of experiments. Presently, Praveen Shanbhag, Santosh, Mathematics tutors, Prasad Shanbhag, Halesh, Physics instructors, Mrs Sneha, Biology, Shreekanth and Prasanna, chemistry have made huge contributions in making the teachers learn theory via doing experiments. I am truly grateful to all of them.

A team of 15 contract employees or staff assistants is the backbone of TDC. Gajanan and Amit looked after the office. Amit is a mess manager. Ravi drove an old Qualis and made the TDC idea keep moving. Success of the TDC training program can be traced to good food cooked with love and affection

by two men Nagaraj and Prasahanth. Srinivas, Suresh and Tammanna looked after water and room allotments. Vijay and Veeresh maintained electricity. Manju and Prakash did glass blowing. Murthy, Suri and Nagaraj managed laboratories. All of them did all the types of jobs, including serving food, cleaning the centre, security of the place by guarding the TDC in the day and night on all 365 days two at a time. They have been extremely loyal to the system. I am really grateful to all of them. Thanks to Hemanth Kumar, Resident Engineer would come to help and solve all the technical problems. We gratefully acknowledge the support from the Institute, CEC office, purchase office and F&A headed by FC, Indumati Srinivasan.

During the last 10 years, Govt of Karnataka, MHRD Govt. of India under Padit Madan Mohan National Mission for Teachers and Teaching and L&T Technologies Services under CSR have provided financial support for training. We gratefully acknowledge their support for this giant experiment.

M. S. Hegde



*Talent Development Center,
Kudapura Campus*



Science Teachers' Training at Four Levels

Knowledge imparted to students by a teacher is proportional to teacher's knowledge. One teacher teaches about 100–150 students per year in high schools, preuniversities (11th and 12th classes), degree colleges and universities in India. If one teacher is enriched with knowledge, 100–150 students get benefited every year. Students leave the schools with the knowledge. On the contrary, knowledge of the trained teacher remains in the institution till he/she retires. Therefore, training the teachers to enrich their knowledge has a huge multiplying effect.

A general assumption is that a BSc degree holder with PCM subjects is fully knowledgeable to teach mathematics in a high school. However, this assumption may not be entirely correct as most of the high

scorers in BSc go to MSc and to other higher studies, leaving less scoring ones to take up teaching jobs. It is expected that a teacher must be able to score 100% marks. We at the Talent Development Centre (TDC) of Indian Institute of Science in Challakere campus have found that the average marks, scored by 4000 high school teachers of Karnataka in a good SSLC mathematics paper without multiple choice answers and choices among the questions, is just 22%. The main reason for poor performance, and hence the poor quality of teaching is due to limited knowledge within the syllabus and books. Hardly 10% of them got more than a passing mark of 35%. This may be difficult to believe but it is a fact. A teacher once appointed for a permanent service cannot be replaced till he/she retires. Therefore, an alternative is to make the teacher

equipped with knowledge by training him/her on what he/she does not know and what he/she must know to teach.

A state like Karnataka has about 14,000 high schools. Each high school with one division comprising about 50 students each in 8th, 9th and 10th classes has one mathematics teacher. By training about 14,000 mathematics teachers, a total of 18 lakh students from 8th, 9th and 10th classes will be benefitted every year. If 1500 teachers are trained per year, all the schools will have trained teachers in a span of 7 to 10 years. Each teacher can have training once in 10 years taking into account freshly appointed teachers. Periodic training becomes essential to cope with upward revision of books and syllabus. Training teachers has thus huge advantage for students to acquire the required knowledge.

Up to secondary school (SSLC), education is compulsory to the children. Most state governments have made education free in government and government-aided schools up to SSLC. Further, to bring up the enrolment nearly to 100%, state governments have started preschool education by organising lower and upper kindergarten (LKG and UKG) classes. The school dropout number has also come down. In Karnataka, the dropout percentage has been less than 1.5% up to 7th class and less than 5% in high schools (8th to 10th classes). In addition, the mid-day meal scheme has

contributed hugely to achieve success in mass education. However, towards the late 1980s, India has moved from mass education to higher education. Prerequisite for higher education is predominantly depends on the quality of teaching and learning at high school level (8th, 9th and 10th classes) as well as preuniversity (PU) level (11th and 12th classes).

Education System in India – A General Overview

A majority of children after 4 years are enrolled in LKG. They move to UKG and finally to the first standard at an age of six. Up to class 5, education relates to literacy. Children study by reading and writing mainly in mother tongue with English as the second language. Learning mathematics by chanting tables $1 \times 1 = 1$ to $10 \times 10 = 100$ (in the first standard) and $11 \times 1 = 11$ to $20 \times 10 = 200$ (in the second standard) is a norm in Indian schools. This particular education stays throughout their life because they chant the tables at least 300 times and write at least 100 times to remember it permanently. It is noteworthy that the practice of mathematics tables taught and learnt is the knowledge everyone correctly remembers and uses the rest of his/her life. Also, addition, subtraction, multiplication, division, numbers, shapes, idea of measurements and comparisons (such

as more or less, big or small, heavier or lighter) are taught up to 5th class. At the age of 12, in the 6th class, they start learning mathematics as a subject. Science is introduced by describing their environment around them such as food, shelter, earth, hills, mountains, valleys, sun, moon, light, water, river, sea, naturally occurring materials and life on earth. In most states of our country, primary education ends at 7th class. In some states, 1st to 5th classes are lower primary, 6th, to 8th classes are higher primary and 9th and 10th classes are considered as high schools. The school certifies that children who pass 7th class can move to another school called high school to study the subjects for 8th, 9th and 10th classes. Up to class 10, there is no public examination as of now. The children acquire knowledge more than the text books prescribed. There was a move to club class 8 in the upper primary and 9th to 12th classes as high school; however, this system has not succeeded because of various logistic reasons. As it stands today, the present education system in India comprises primary school (1st to 7th), higher secondary (8th to 10th), PU (11th and 12th), undergraduate (UG) college study (3 years, BSc/BCom/BA) and university postgraduate (PG) study (2 years, MSc/MA/MCom). Thus, our system requires 17 years of education (7 + 3 + 2 + 3 + 2 years) to acquire an MSc degree for a child entering first standard at the age of six. Whereas, it takes 18 years in USA, France, UK, Germany, Japan, China and in most of

the other countries to complete MSc (10 + 2 + 4 + 2 years), because they study one year more for a UG BA/BSc degree.

It is in class 8, 9 and 10, commonly called high school, where the study separates into science, mathematics, social science and languages. Physical education is a part of total education. At the end of three years of high school, they need to take a public examination. Most states are adopting NCERT text books translated into regional languages. There is one SSLC examination in states like Karnataka for all the class 10th students studying in government or government-aided or private, Kannada-, Urdu- or English-medium schools. Uniformity in following the curriculum of NCERT books by the state has made this possible.

Passing percentages in SSLC vary between 60% and 88% among different districts of Karnataka. About 1% to 2% of students go to ITI and Diploma to study technical education. Most students move to PU colleges to study science, commerce or arts subjects. It is more than four decades ago that PU colleges have been established, which were separated from the degree colleges. In each state, PU board or PU department has been established administering the PU (11th and 12th classes) education.

As state governments run schools

teaching up to PU level classes, central government too runs over 1000 Kendriya Vidyalaya (KV) from KG to 12th standards. The KV system essentially caters to the children of central government employees. They are located generally near Indian Institute of Technologies (IITs), public sector undertaking, military establishments and other central government establishments. The KVs are non-residential schools. More recently, around 1990s, over 600 Jawahar Navodaya Vidyalaya (JNV) residential schools have been established on the model of the Doon School in Dehradun. Each JNV school admits 80 students at 6th standard by selection with reservations as prescribed by the constitution. JNV schools teach up to 12 classes. JNVs are located in rural areas in a district. Except in Tamil Nadu, every district in India has one JNV. These are the schools sought after by the students/parents because of good quality education they receive compared to state-run institutions. Entire education from standard 6th to 12th is free as the entire cost is borne by the central government. Both KV and JNV schools follow NCERT books for teaching and conducting laboratory experiments.

On the JNV model, a large number of residential schools in each state have been established. These residential schools admit more percentages of OBC, SC and ST students.

Four Years of Professional Education

In the year 2017, about 239 lakh students in India went for higher education study after passing PU. Among them, about 49 lakh students got enrolled for three years of BSc degrees. Majority of them opted for three subjects among the basic sciences, physics, chemistry, mathematics, statistics, botany, zoology and biology. Distribution of students going to different streams is as follows: Four years of engineering (16%), four years of medicine, BPharma and agriculture (6%) and three years of science (20%), arts (40%) and commerce (18%).

Most engineering colleges in India are following IIT pattern of education as the IITs set the standard of engineering degree. A national body called the All India Council for Technical Education (AICTE) was set up in 1945 to conduct/control technical education. It continues to be a "College Sanctioning" body. Similarly, the All India Institute of Medical Sciences (AIIMS) and a few other leading medical institutions set the standard for MBBS. Another apex body founded in 1911, called Indian Council of Medical Research (ICMR), formulates, coordinates and promotes biomedical research. It is also a "College Sanctioning" body. The Indian Council of Agricultural Research (ICAR) governs education in agriculture sciences. This body has been largely effective to impart good education

in agriculture sciences. Indian Agricultural Research Institute (IARI) at Pusa in New Delhi and Pantnagar and Bangalore Agriculture Universities are some of the role models for agriculture science. BSc Agriculture is a standard professional four-year degree course. Thus, in all the fields, institutions awarding four-year professional degrees are established in India, which are comparable to institutions in rest of the world. Top institutions such as IISc, IITs, AIIMS and IARI are the role models for other institutions to follow. These leading institutions have their role models elsewhere in the world to follow such as Oxford, Cambridge, Harvard, MIT, Stanford and so on. This is because students with four-year professional degrees from India's top institutions have to compete with the best in the world for higher studies. A learning cycle in India is given below.

Learning Cycle

In general, four-year professional degree holders receive education comparable to their counterparts in advanced countries. Four-year UG degree holders in India are qualified to go for PG studies in India or anywhere else in the world. The quality of education is maintained because PhD degree holders usually teach the four-year professional degree to students in India.

In contrast, there are no role models for three-year degree courses. University teachers with a PhD teach only MSc students in their campuses and do not teach three-year BSc degree students. Three-year degree students are educated in degree colleges. Three-year degree students are taught mostly by those who do not have a PhD degree. The Indian BSc, BA, BCom degree holders are not eligible to get enrolled for MS and PhD in Europe or USA even if they can afford to study by paying fees. They are not qualified to enrol for PhD in India. They have little opportunities to improve their qualifications.

In the learning cycle, students climb up the ladder acquiring BSc, MSc and PhD degrees in science and become university teachers. At each stage, students after completion of their degrees enter into other professions and also take up jobs.

University teachers teach graduate students leading to MSc and PhD degrees. In turn, teachers with MSc degree teach BSc students and also PU students. BSc degree holders teach high school students. Students from standard 1st to 7th in primary schools are taught by PU passed teachers with a certificate. University is at the centre of learning, which sets the standard. If a university is good, then entire education system becomes good. If the university is not up to the standard, students get less and less

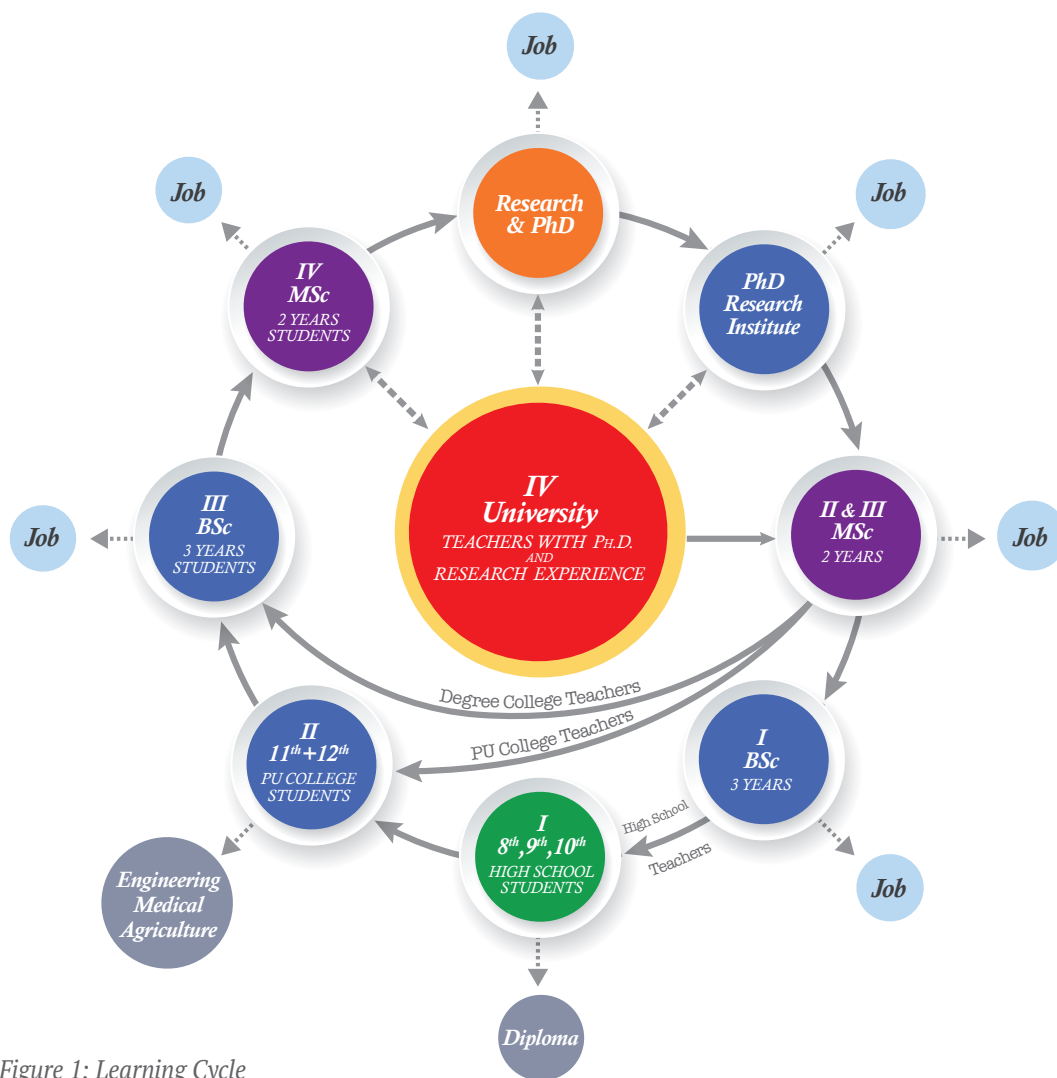

Figure 1: Learning Cycle

education in each cycle leading to deterioration in the education standard.

Less than 1% of MSc postgraduates in India qualify national eligibility test (NET) for research and teaching. Less than 5% among the 1% who cleared NET may get admission to do research in the universities in USA, France, England and Germany. This tells it all on the quality of learning science in India. This essentially means universities, which are the centres of higher knowledge in the learning cycle, are indeed very poor in imparting desired level of knowledge.

Science includes mathematics as well. From the learning cycle, four levels of science education emerge: High

school level (8th–10th classes), PU level (11th and 12th class), degree college level (BSc 1st, 2nd and 3rd year classes) and universities/PG college level (MSc degree). Therefore, if we train science and mathematics teachers at high school, PU colleges, BSc degree colleges and universities, the entire spectrum of science education will be covered. It will make our science education system strong. It will be a new direction for science education. This can be a new strategy to improve science education in India. Similar learning cycle applies to studies in three-year commerce and three-year BA degree holders. BCom degree holders are not qualified to teach high school students. In this book, we address issues related to learning science in India.

Why IISc Should Take up Teachers' Training at All Levels?

Indian Institute of Science was started in 1909 by the great visionary Sir J N Tata to provide superior knowledge to less fortunate Indians. During the first one hundred years, the institute has produced men of eminence who provided leadership in science and technology. Sir C V Raman, Homi Bhabha, Vikram Sarabhai, Sathish Dhavan, G N Ramachandran, C N R Rao and scores of directors of IITs, heads of key industries such as BEL, ITI, key secretaries to the government in postindependent India have come from IISc. Most scholars who shaped destiny of India in the field of science and technology have passed through IISc. Nationalism and national interest are inbuilt in IISc. Having been a student of IIT Kanpur between 1970 and 1976, and later spending rest of my life in IISc, I am a witness to the development of science and technology for over 50 years in India. I find IISc stand apart on ideals from rest of the institutions and universities in India. IISc has always tried to be one among the best in the world and to become an ideal institution – as seen from how it conducts itself. The main driving forces being high scientific temperament, ethical work culture, technological innovation, higher level of learning and necessity to venture into new knowledge domain. IISc has always catered to the needs in India by disseminating the knowledge it

acquired. Similarly, commitment of the institution as a whole to do the best academics at each point of time has been imbibed by the students and associates of IISc. Continuously looking at the IISc icon tower with a foreground surrounded by tall trees and the vision of J N Tata (statue) give an instant feeling of association with the institute to the students and faculty. It also inspires one to create new knowledge, which becomes useful to mankind. Once men in the institute start thinking, knowledge develops and commitment grows spontaneously.

The institute started several new centres during the last 50 years. Centre for Atmospheric Science, Centre of Ecological Science, Climate Research Centre, Centre for Earth Science, Centre for Neuroscience, Solid-state Chemistry, Materials Research Centre, Molecular Biophysics, Brain Research Centre, Application of Science and Technology to Rural Areas (ASTRA) – renamed as Centre for Sustainable Technology, Energy Research Centre, Digits and School of Automation are a few examples how the institute expands into new knowledge creators. The TDC to train teachers is one such new addition in 2011.

During the early 1970s, a few professors such as Vasudev Murthy, S V Subramaniam, V Krishnan, Mahadevan and Vithal Rao felt the need for training science teachers initially from nearby schools. This was continued for

30 years when the faculty members conducted training to high school teachers in science and mathematics for ten days in each district of Karnataka. This is perhaps the first example where the faculty members of the central institution going down to the level of state government-run schools to teach science and mathematics. Need for a permanent centre was felt all along. Most of the points raised on 'why teachers need training and who needs training' were part of continuous discussion. No other university or institution in India conceived the idea of imparting quality training to the teachers on a mass scale. There was no model/benchmark for science and mathematics teachers' training program available to IISc. Coinciding with the Knowledge Commission Report 2009 for a National Commission for Teachers Training, IISc acquired a second campus. This led to a discussion in the faculty meetings of IISc in the centenary year celebration, which finally culminated into taking up teachers' training at all levels in science and mathematics in the second campus at Challakere.

If the BSc graduates coming out from the colleges under state universities have adequate knowledge to teach high school students, there is no need for training. If the PU teachers holding MSc degree from one or the other state universities can satisfy the needs of students to compete for professional education, there is no

need for training. If the MSc degree holders can teach and produce good BSc graduates in science, there is no need for training the college teachers. If the universities produce quality MSc degree holders there is no need to have training for the university teachers. As it stands, the percentage of competent teachers/researchers in the state universities is not more than 15%. The teaching programs in colleges and PG departments and universities are run by guest faculties to the extent of 50% to 80%. The contract/guest lecturers have no stake beyond the duty they do even in short term. Many of them do not have a PhD degree. There is no urge and commitment in these teachers to do well because they do not see any future. Continuous decrease in the appointment of regular teachers at BSc degree colleges and university PG departments by selection processes has brought down the level of learning. Increase in the enrolment rate is not followed with increase in the appointment of qualified teachers. The net result is substantially lower level of knowledge imparted to the students both at BSc and MSc levels.

The state universities are burdened with teaching vast number of students. The school and college teachers have acquired knowledge to the extent what state university can offer during their BSc and MSc classes. The state university teachers have already imparted knowledge to best of their ability to BSc and MSc students.

Therefore, any training program for teachers of high school, PU and BSc students by the same faculty who have taught them for their respective degree will not be able to enrich teachers' knowledge further.

The percentage of competent researchers in the central institutions such as IISc is substantially high. Further, the knowledge they have is also relatively high because they need to compete with the best in the world for their own existence. Selection processes and promotion policies of central institutions are lot more stringent based on merit in comparison to state universities. What is demanded and expected from the faculty members in the central institutions are research and creation of knowledge, while teaching methodology is only a part of the work they do. Therefore, central institutions, have a stake to instil confidence in the teachers of state universities to justify their positions. They may not need to spend much time to teach the subjects covered till BSc and MSc. Teachers need to be taught by those who are far more knowledgeable and practicing scientists. Every teacher wants to learn from the best. Therefore, IISc and such institutions should involve in teachers' training at all levels. The teachers at the four levels had no access for a superior knowledge hitherto. If the training program imparts higher level of knowledge, which is expected from IISc and such institutes, the trained teachers can impart more knowledge

to the students. In turn, level of learning gets raised to a higher level. State governments must exploit this win-win situation to impart best education for which they are committed. Besides, such a training program is highly cost effective too. Only one teacher needs to be trained to teach 120 students every year. With this methodology and motto, IISc started a training centre called "Talent Development Centre" (TDC) at its new campus at Challakere to train science and mathematics teachers of all levels.

Goal of TDC

Goal is to train science teachers mainly from state-run institutions at four levels. There is a necessity to find a mechanism to connect state institutions with central government institutions. An official academic connectivity between state government institution and central institutions does not exist as of now. This is to be established because such a connectivity has not happened by mutual arrangements so far. IISc has a large pool of faculty members both in science and engineering disciplines – about 40 small and big departments with over 500 faculty members. Basic science – mathematics, physics, chemistry and biology – forms the basis for all the development of a nation. At high schools, students start studying science and mathematics. Therefore, it is important to concentrate on

teachers teaching science in high schools. Subsequently, quality training for PU, BSc and MSc teachers teaching mathematics, physics, chemistry and biology can be provided. IISc should take up teachers' training because IISc is supported all through its 100 years of working by the government.

In the learning cycle, we needed to start at some point. Since we had some idea on high school teachers' training, we started with high schools. Broad ideas were to train all the high school science and mathematics teachers from Karnataka state government and government-aided schools because they needed proper training. Also, it is the social responsibility to uplift the less privileged in the society as over 65% of children in Karnataka who study in government and government-aided schools cannot afford education from private schools and pay the transportation charges for yellow buses. It is a known fact that government schools are looked down upon. It is the responsibility of the state government to provide quality education to less fortunate, economically and socially weaker section of the state. Government is committed to provide best possible education to its children.

Then we progressed towards training PU or 11th + 12th class teachers, BSc college teachers and finally university/PG teachers teaching MSc in basic sciences. The broad goal was to

produce a successfully working model and setup a good benchmark for training programs for teachers teaching science and mathematics at all four levels. If the program has to succeed, scale of training should expand so as to reach out to all the teachers. This means, at least 2000 to 3000 teachers must be trained every year, so that one cycle will be over in 8 to 10 years.

IISc being an all India institute, its programs should be spread out to all parts of the India including far North to North East. However, it is not conceivable for IISc to take up such huge responsibility for India. What is expected is that if the model training yields results for the students to acquire required knowledge, IITs, Indian Institute of Science Education and Research (IISERs) and other leading central universities in each state can adopt the program to fulfil the needs of respective states. In turn, they can improve the program. The goal is to develop model training programs for science and mathematics teachers at four levels, impart training to large number of teachers and assess the impact of trained teachers on the students. If successful, induce other institutions to have a national commitment to provide better science and mathematics education.

Talent Development Centre – How It Got Started

IISc Acquires Land at Challakere for its Second Campus

In the year 2008, one year before centenary celebration of IISc in 2009, Prof Balaram, Director, was keen to know from his faculty that what IISc should do for the next 100 years? First opinion of the faculty was to have a second campus for the Institute. This was because the present campus was too crowded. Major expansion of academic activity needed more faculty and students and space. Old hostels were demolished to build the new ones for want of space. Suggestion of a second campus was taken seriously. The Director instituted a committee to search for land in Karnataka. Land for the IISc Bangalore campus was donated by the then Maharaja of Mysore. IISc has been supported by Karnataka state government all along.

Therefore, preference was given to find land within Karnataka.

Within a short period of 6 months, a committee headed by Prof KPJ Reddy narrowed down its choices with the help of the chief secretary, Karnataka to the present location at Challakere, Khudapura. The government had already pledged adjacent 4000 acres to the Defence Research and Development Organisation (DRDO). The Director came with a bus full of senior professors and the committee members. A large number of Civil Engineering Department professors came to assess the land. The Deputy Commissioner of Chitradurga, Mr Amlan Biswas was there to show the government-owned encumbrance free revenue land. The Karnataka government was keen to bring central institutions to one of its most

backward districts Chitradurga. The government was looking for economic and education development. The geological stability of the land was approved by the civil engineers. The Director was gauging the land. Even up to 10 to 15 km till eye could gauge, there were no buildings and could not find any structure. He felt it is perfectly isolated for academic pursuit. He did not need persuasion to accept the state government's offer. By the end of 2009, 1500 acres were transferred to IISc. The government put a condition that in a year IISc should start academic activities. Otherwise, the land should be returned.

The Challakere Empowered Committee headed by Prof BN Raghunandan was appointed to find ways to develop the campus. A special officer Mr Jagadeesh was also appointed to support Prof Raghunandan. There was no water or tea available within 7 km distance. Being the Dean of Science faculty during 2008 to 2010, I was invited for all the visits. And I became witness, many a times party to the developments.

Last of the IISc High School Teachers' Training at the District Centres

It was Sunday, the 27th December 2009. Professor Umerji was conducting a high School teachers' training

program at MRC building at IISc. This time it was arranged at IISc Bangalore campus for the Chikkaballapur and Bangalore Rural District high school teachers. This was in continuation of teachers' training every year in December where IISc was conducting under the Centre for Continuing Education. As per the arrangement, DSERT, Karnataka deputed 120 teachers from Chikkaballapur and Bangalore. I gave a chemistry lecture from 9 to 10:30 am. Professor Umarji had invited the Director Prof Balaram to address the teachers. The Director came at 11 am. Awed by his charm, teachers kept looking at him standing and would not sit down. He persuaded the teachers to sit down. He kept on looking at the teachers engrossed in some thoughts for noticeably long period of time. Words were not coming out. Finally, he said that he came to see the teachers. Stopped talking for another two minutes. Then he said, it is all good to teach the teachers but it is not done as should be. There should be a permanent place in the institute for this purpose. There should be a laboratory. Suddenly stopped his speech and wished the teachers well. He told "Professor Umarji will take care of you" and left the MRC Lecture Hall.

I walked with him to his laboratory in the old chemical engineering building, and stopped at the usual corner below his lab where he keeps talking to faculty members or anyone else when he returns from his office below the

tower (main building). He knew that I was participating in the high school teachers' training program. He wanted to know more about high school science teachers' training going on for about 30 years. It was once a year affair. A few faculty members committed to this cause were going to a district centre in Karnataka and conduct 10 days non-residential training for high school teachers. About 120 teachers used to be deputed by the DSERT. He went on asking details. Before Umerji, I was the convener after Prof HL Bhat's turn. After talking for about 45 minutes both standing, he came up with a sentence – "this is the kind of program we should be developing in the new campus". We need less facilities and the government would appreciate our contributions. It was fully agreeable. Then he asked me what plans I have after July 2010 – formally retiring from IISc. I was too casual – "yes, can be done and I can do it" not realising what I committed to him. Since then he would ask Raghunandan to take me to Challekere whenever he visited. I accompanied Raghunandan several times, almost twice a month.

TDC – IISc Starts in the Sheep-breeding Farm

On 18th July 2010, Sunday, Raghunandan, Venkatram Reddy and I visited the Challakere Campus along with Jagadeesh. In early 1970s, the then

Chief Minister of Karnataka, Mr Devaraj Urs had started a sheep-breeding farm adjacent to the 1500-acre land. He had invited Australian breeders to develop special breeds for wool and meat for developing this region economically. The farm ran for about 20 years till 1991 and most of it got closed once the Australians left in the mid 1980s. A truncated part still exists. All the staff quarters were vacated and remained unused.

An old building belonging to the sheep-breeding farm was given to us by the state government to have a foothold in the new campus. This building was getting refurbished. A lot of buildings, presumably the staff quarters, which were completely dilapidated were there to see. Manjanna, a supervisor of Nirmithi Kendra looking after the repair work of the guest house, opened one by one. Snakes, birds and lizards had made home for themselves in those buildings.



TDC before renovation



TDC after renovation



Guest house



Dinning hall



Hostel blocks



Chairman, Council IISc Prof. P Rama Rao



Director PU Board Dr. Rashmi



Professor JM Tarascon, College the France



Professor P K Gosh, IIT Kanpur



Professor H C Verma, IIT Kanpur



Professor T V Ramakrishnan FRS, IISc Physics



*Professor Sujatha Ramadorai,
TIFR Mumbai*



*Releasing Rs. 2 crore from DST by Mr. Janardhan Swamy, MP
& Mr. Amlan Biswas, DC to Prof. B N Raghunandan, Oct 2010*



*Inaugurated on 26th February 2011 by
Sri B.S Yaddiyurappa, CM*



*Dr. Kumar Naik,
Secretary Education Department, Karnataka*



Professor Balaram discussing with teachers



Dr. APJ Abdul Kalam visited on 08/11/2011



Dr. APJ Abdul Kalam interacting with teachers



DG set for the centre



Workshop



UPS and Internet



Welding



Electrical control



Old Qaulis given by IISC and a driver

Infrastructure at the TDC

An idea struck to us that these buildings can be put to use. As Manjanna opened the rooms one by one, we counted the number of beds that can be put for residential training teachers. Total number of beds that can be accommodated in the 28 quarters came to be 120, which is the exact number we were looking for. There were three more buildings unused with possible transit accommodation for the professors.

Several sheep pens on the other side of the road were there, which were vacant, and suddenly a possibility of conversion of a shed into a lecture hall flashed. On the way, Mr Rehmathulla Khan, Asst Director of truncated sheep-breeding farm was curious to know what we were up to. The farm is popularly called "KURI FARM". Khan was asked if there were any free sheds. He asked why we would need a shed. When explained the idea of teachers' training, he suddenly said, there is a full building called "Sheep-breeding Training Centre" unused for 18 to 20 years. You can take it. I first came in to the farm building. Sick sheep were found in the lecture halls. Much of it was closed when we visited the center. But it was convertible for a training program. Raghunandan came in next and while coming out, we exchanged deep look at each other. He signalled me – what is your commitment? I said, if the place was made available,

I would stay here and convert it into a teacher training centre. Shook hands and formally agreed to proceed with the idea without talking a word more. On the way back inside the car, our discussion was centred on the cost to repair and reconstruct the residential quarters and the centre to conduct the training. Professor Venkatram Reddy lent his civil engineering knowledge and estimated a cost of two crores to convert the sheep-breeding farm into a teachers' training centre.

Next two days I sat down and sent one page with 20 points note to the Director on how to start a TDC for teachers' training at Challakere with Rs. 2 crores as the initial expenditure. Professor Balaram wanted to see the place. His visit had to wait till August 30 for the convenience of Associate Director to accompany. On Aug 30, 2010 Director came with a bus full of faculty. We showed the place - both hostel buildings and the Centre. Instantly he agreed to the idea of starting teachers' training and he asked Mr Jagadeesh to request the Deputy Commissioner of Chitradurga for leasing out this facility. The entire facility was leased to IISc for 10 years in less than a month. However, two crore Rupees from the Institute was not forthcoming. With the indication by the Director to look for funds, a project proposal to start residential training program was submitted to the Secretary, DST, Karnataka, Mr Manoli, an alumni of IISc. He was positive.

Happily, Mr Janardan Swamy, an alumni of IISc was Member of Parliament from Chitradurga District took interest to develop Challakere campus. He could get a sanction letter of two crore rupees from the State Govt. by the end of Nov. 2010. Mid December, Nirmithi Kendra of Chitradurga District under the DC, Mr Amlan Biswas, took up the work to refurbish the Centre. The DC took a lot of interest and got all the facilities installed in time which included road, water tank, water supply, dining hall, furniture, cots and other facilities for residential program including equipping kitchen for 150 people in just 72 days.

On the academic side preparation of class rooms, benches, projection facilities, and laboratory for the teachers to do experiments, high school level equipment, electricity, UPS, Internet were ordered, obtained and installed. 8 mbps bandwidth internet with Wi-Fi was installed by Professor Anurag Kumar (presently Director of IISc) via a point to point BSNL lease line from IISc SERC to TDC. Finally, on Feb. 26, 2011 at 12 noon, TDC to train High School Teachers was inaugurated by the then Chief Minister Sri Yaddiyurappa. At 3 pm, Professor G. Padmanaban, former director of IISc, inaugurated the first teachers' training program. Everybody except the old guard left the Centre to Bangalore leaving behind 110 teachers from Chitradurga. The old guard who were running the district wise training managed to

run 10 days program. There was no leader/convener appointed by the Institute. I was working for Professor Balaram informally. Everyone assumed I was the leader running the program! Professor Balaram had made one good gesture by asking me to show the TDC to the Chief Minister. The TDC was reasonably equipped with laboratories. Equipment for running the training, good class rooms were in place within those two crores from the Karnataka Govt. DST. The training itself was far from satisfactory. Food arrangement was unsatisfactory. Yet it was considered a good beginning. The program closed on 8th March 2011. Thus, the academic activity of IISc second campus started in the sheep-breeding farm.

Teething troubles

I was the only one in the centre on the 9th March staying back from Bangalore facing the 16 freshly appointed contract employees. They had reported on Feb. 22, four days before the start. No one took charge of them. No one knew what his duties were. All of them had just one to two pairs of cloths. All came from nearby local villages. There were no instructions on what these 16 should do. They had no money to go back to their homes. On the food front, there were two gas cylinders which soon went empty. With no gas and no ration to make food, facing

too many unpleasant situations during the 10 days, I was exhausted and went to deep depression. I was too foolish not to have drawn enough money from my personal account while coming on 14th February to prepare for the inauguration. Yet, I had brought Rs 50 thousand. I was left with about Rs. 10 thousand. Mr Sunil from Chitradurga had done a lot of business out of two crores. I requested him to get 25 kg of rice and 10 kg of Dal. He obliged and sent them by an auto rickshaw. Then I went to local Indane gas dealer at Challakere in a hired car. I requested Shankarlinga, an agent to get two cylinders for the Centre which would cost about Rs. 6 thousand. It was a hot day and I was getting dehydrated and about to collapse and yet he would not allow me to go into the shade. Soon he flatly refused to book gas cylinders for the Centre and told me 'you have no authority to sign for the cylinders'. Then only I realised the value of a signature. He was a gentleman. He said he would make one concession: he would give the cylinder in my personal name condoning residential address proof because he had heard about the good work, I had done to Challakere. Even today, gas cylinders are all in the personal names of the individuals of the Centre. I gave away all the shirts to 16 contract employees except one I was wearing. Had got some food-ration for them to cook and eat and be in the Centre. I came back every three weeks and bought ration costing about Rs. 20 thousand each

time from my money and maintained 16 contract employees for the full summer till June. Mr Suresh, one of the 16 employees, got Ragi from his home and we cooked Ragi Ball in TDC. This was a cheaper food. I left to Bangalore on the night of 9th March 2011 leaving behind the 16 contract employees with some food for their survival, but not before giving money to those boys to go back home by bus.

The Centre was running with rural electricity meaning three hours of 3 phase power and rest of the time single phase power in the event of power cut. Agony of not having electricity most of the time was the most difficult thing to bear. Sleeping in the night without fans was a unique and trying experience. I used to request Mr Jagadish and Professor Raghunandan to stay a few nights in the campus. They certainly missed the excitement and agony of staying in the nights in TDC without electricity!

Report to IISc Court and Request for Continuation to DST

I was quick to write a report on TDC in a short period of time and it was given to the IISc Court members in the March meeting. There was a huge appreciation by the Court and Council Members. Also submitted for grant for continuation of training in TDC to the DST, Karnataka. The report was

also submitted to DST Karnataka. DST Secretary Mr Vidyashankar, a friend of Professor Balaram, was gracious to get Rs. 1.5 Crore approved in the budget. This was the big step for continuation of the training program which came to be known as 'ON Going Program' of DST till 2019.

Professor Balaram and I had extensive discussion on how to go about developing TDC during the month of May 2011. Finally, I had to mention to him that I could not function at TDC unless my signature is valid. He understood the point in less than 1 second. In a week's time, he constituted a committee for running TDC and appointed me the Convener. I was already a CSIR Emeritus Scientist supported by the Institute and so I was entitled an extra Rs. 15 thousand per month salary over and above my decent pension. Since the time I was made Convener, TDC, IISc Chalakere Campus I am here working for the Institute. Director gave an old Toyota Qualis Institute vehicle for commuting, which has been serving TDC even today.

Teacher training resumes in TDC

Teachers' training program resumed in June 2011. Two batches for teachers came from Chitradurga and one from Davanagere, sent by DDPIs. Old arrangement from the DSERT had

stopped. Getting the Karnataka High School teaches to the training was the biggest problem we faced. DPI of Karnataka finally ordered the DDPIs to send the teachers. This arrangement had to be renewed every year.

Finding a method of training science and mathematics teachers was a challenge with lots of constraints. In ten days of residential program, entire subject for 8th, 9th and 10th class was to be covered. No program of teachers' training is more than 5 days in Karnataka. The Govt. had made an exception to IISc by extending it to 10 days. Unless the training became useful to teachers, entire idea was bound to fail. So, it was challenging to formulate a proper training program. The earlier 10 days programs in the district centres were not at all effective. 120 teachers trained per year was too small a number to make any impact. A new method had to be discovered. In the second training program one teacher told that what they need is only the content enrichment and nothing else. They should be taught what they do not know and what they need to know within the text book. This was a big input for us.

On the infrastructure front, residential facility for 120 teachers in the 28 buildings was created. Accommodation for 8 faculty members was available in the two guest houses. Mess was created to make food for 150 people. Internet with 8 mbps speed facility

was put in place. Two lecture halls with projection facility was created. Three phase power supply was available for only 3 hours and rest of the time a single-phase power was given. UPS was the main source of power to run the classes. 65 KVA Diesel set was available as a substitute. Water, from the only bore well was available but unfit to drink because it had more than 1000 mg of salt per liter. Bottled drinking water had to be bought. A small mechanical work shop and a glass blowing shop were established to make small apparatus. Two assistants were taken to IISc Bangalore to get them trained in glass blowing technique. The quadrangle in the central part of the TDC building had open roof and in the scorching sun, it was impossible to be inside the building. Quadrangle was to be covered with an inverted roof keeping central square open. That too needed to be closed because of rain and too much light . We got the working tables for experiments made locally at low cost. Getting the bills passed was quite an effort. Advances to the extent of Rs. 5 to 8 lakhs were brought from IISc Bangalore and submitted the accounts. Challakere was not used to proper TIN numbered receipts. This had to be established. The task of getting cash, submit the accounts, answer all the quarries to settle bills, getting next advance in time for the training and managing the centre to run till the next cash arrived was a nightmare. Office staff of IISc including FC were not aware of the

harsh condition to run a program away 250 km distance from Bangalore. The fact that 'If there is no money, there is no food' was not felt at the account's office of IISc. Eventually, a visit by the FC Indumati Srinivasan made life somewhat comfortable.

The training was run by getting the faculty members from IISc, Bangalore and occasionally from JNC and some BSc Degree Colleges. They came previous evening, spent two nights and left third day by car. Globus Travels was identified to ferry professors from Bangalore. Till today, Globus Travels serves our transportation needs and submits the bills as per the norms prescribed by the Institute. The faculty who are to come to give lectures are picked up from their houses in Bangalore and dropped back to their houses when they returned. This was a satisfactory arrangement which continues till today. Faculty was given Rs. two thousand in cash for a lecture as per the norms in IISc. They were to declare it in their IT returns.

Food was made free for all the people in the Centre and also to all those who visited for academic or other work because there is no place even now to eat even if they want to pay. TDC cannot take cash and provide food. Quality of food was standardised and improved. The day started with a tea and rusks/ bread at the Guest House G1 at 7 am. At 8-00 am, classes start. Breakfast was served at 9-30 after one

lecture. Lunch at 1-30 pm, tea/coffee (with and without sugar) and snacks at 5-30 pm, dinner at 8 pm. This schedule was formalised in the second program and has remained the same till today. Careful management of first self-service and then assistants serving on the table in a small plate reduced food waste. Oil free chapatti (Phulka Roti) was cooked in a newly discovered stove which indeed helped reduce oil consumption. Frying items were avoided to make sure that teachers did not fall ill after eating excess food. Teachers were sent to nearby doctor in Nayakana Hatti if they fell ill – thanks to the Institute Qualis car and a local assistant Ravi who knew doctors. Lady teachers were allowed to bring their children with a spouse during the training program. All the windows of each building were covered with Netlon mesh to stop mosquitos entering inside the rooms. Drinking water – 20 liter can was supplied to each of the buildings. Classes ran from 8 am till late 7.00 pm. Since the work had to start collecting milk at 6 am to provide tea to the teachers and serve food till 9 pm, 16 contract employees were paid 3 hours of overtime with all the procedures as per the labor laws of Govt. of India. This is one of the factors which helped TDC run smoothly. Assistants were made available all the time for any emergency. Residential requirements were met by this special arrangement. Teachers were kept busy in the evening with an assignment to write. Living condition was at

acceptable level in the refurbished old buildings. Every day the rooms were cleaned by employing extra daily wage employees. The 16 contract employees learnt all the types of work including serving food to repairing instruments, supplying water from bore well, bore well pump repair and maintenance of electricity and diesel generators. They were also security personnel – two of them in turn sleep in the TDC to guard the Centre. A healthy and honest work culture was established. An honest accounting procedure was established. TDC indeed works for the purpose for which it was created. Success of TDC can be traced to nutritious and healthy food to participants and availability of food to all assistants and faculty on all 365 days. Money for food came from the grants received from the State Govt. The Cooks and the local contract employees were fully aware of the value of the food. So, they tried reduce the cost enormously. Excellent attitude of two cooks from nearby villages fully supported by other contract employees of TDC made the place pleasant for all. Their dedication to the centre is complete.

With a reasonably manageable infrastructure to train 120 teacher in a batch, the challenge was how to make the teachers' training effective, interesting, useful and acceptable to teachers and the State Govt. The TDC at IISc – Challakere Campus at Khudapura was in place by the end of 2011 to make a name for itself.

IISc has now built a major facility in its newly built skill development centre (SDC) to conduct teachers' training at all levels. TDC is part of SDC. Lecture halls, laboratories and all the infrastructure were established in the SDC in its new campus. Hostels for 200 teachers is created for the residential teachers' training. Over 2500 science teachers can be trained in TDC per year in addition to improve skills of a large number of Engineers in SDC. Success of 13500 science teachers training in the TDC housed at the sheep-breeding farm has led to development of SDC specifically to train teachers at all levels by IISc in its new campus.

Why Teachers Need Training?

To assess the level of competence, we made a small study in TDC. We requested two batches of 60 PCM teachers teaching high school mathematics to 8, 9 and 10 classes to write their own marks scored in their SSLC, PU, BSc examinations. We observed that the average marks scored by the teachers in their SSLC Mathematics paper was 69%; average marks scored in their PU mathematics being 59% and in BSc, 54%. No one had scored 100% in any one of the examinations. With this knowledge, if they have to make students score 100% in mathematics in SSLC, it would not be easy. True, they will read and teach but primarily, their own knowledge acquired during their studies limits them to make the students score 100%.

Ideally, science and mathematics teachers must:

- Have correct knowledge at least within the text books and syllabus.
- Be clear on the basic concepts in the subjects they teach.
- Realise that science is truth and should be taught with utmost honesty.
- Convey basic concepts/principles of science via experiments.
- Be able to do experiments themselves and show them to the students.
- Bring demonstrations to class rooms and make the subjects easy for the students.
- Be able to construct and conduct demonstrations in the classes.
- Be excited first to excite the students.
- Able to construct and solve the problems based on the theory they teach.

- Upgrade their knowledge – a need to cope with addition of new subjects in the books.
- Learn from those who know the subject without any inferiority/superiority complex.
- Have much higher level of knowledge than the text books or syllabus.
- Be able to cover full subject prescribed in the books and syllabus.
- Give problem/assignments to students, correct/grade them and give them back in time.
- Make the students write the answers correctly.
- Be able to command respect of students through command over subject –knowledge.

Most teachers perhaps are aware of these ideas and ideals. Every teacher desire to be a good teacher. Govt. also knows what should be the attributes and qualifications before appointing teachers through a selection process. But they are unable to get the teachers who possess the above attributes in addition to the required qualification. Based on the BSc and BEd marks, a high school teacher gets appointed only when he/she clears the cut off percentage marks in the merit list. In 2015-16 when they made the merit list to appoint 2000 high school teachers in Karnataka, person with first rank in the merit list scored only 58%. They had to go down to 48% to select as many as possible to fill up the posts.

50% is the minimum marks to qualify for high school teacher post. This is the reality. Obviously, it is difficult to find teachers ideally suited for teaching in large numbers. If they are short of desired knowledge and desirable qualities, how to enrich them with required knowledge? Can a good training fill the gap? Are they talented to acquire knowledge given the chance to learn? Answer seems to be big YES as you browse down this book.

Most of the high scorers in PU examination take up four years professional degree courses. The remaining ones go to three years BSc and two years MSc degree courses. These BSc and MSc graduates become teachers for high school, PU College, BSc students. These teachers need to teach unfiltered students at high school and PU colleges and make them score more than the teachers themselves in their own career. Therefore, teachers need training.

The teachers are already into teaching for 10 to 15 years say in high schools. In the meanwhile, new subjects are added to SSLC. NCERT books which they have not studied in their SSLC are introduced. They may have studied the same subjects in PU and BSc but may not have scored high marks or they may have left certain difficult portion taking recourse to CHOICES available to pass with other subjects. Most teachers have not planned to become

teachers. Most have not revisited text books of lower classes once they cleared the tests and passed. Now they have to teach the students so that the students have to score full marks. If they are not competent for self-study, they need training.

Teachers cannot have choices to leave a subject not to be taught. Students have choices to leave one or two topics and pass the examination studying fewer topics. But teachers are used to leave some topics while they were students. Those topics now become more difficult and they need to teach. Therefore, teachers need training.

The marks scored by students follow normal distribution. This means, most students get average marks around 50% to 70% in a good class. About 10% to 15% students score less than passing marks. Very few score above 70%. But the teacher should be able to score 100% because he needs to teach the subject fully correctly and able to solve all the problems likely to appear in the examination. The final examination questions are from within the subjects in the text books and questions not necessarily from within the book. Since they themselves have not scored above 70%, they need training as to how to score 100% and how to make the students score 100%.

Science in the schools and colleges should be taught with experimental demonstrations. For this, facilities

need to be created. By observing the experiments, students learn science more easily than imagining when taught the same concept on the black board. But the teacher must have the ability to perform the experiments in the class room. Sadly, one can go and see a school and find that science is learnt in class rooms on black boards. Many a times the teachers themselves have not performed the experiments given in the text books. Activity based learning is now prescribed in the NCERT books. Even if the facilities are made available, if the teachers have not performed the experiments, they will not be comfortable to do demonstration. Therefore, teachers need training.

Today, even in high school mathematics, solving problems based on theorems has become compulsory. NCERT books are written that way. Teachers who have not studied NCERT books in their time are not used to solving problems. So, the teachers need training.

University frames the syllabus broadly based on University Grants Commission (UGC) guidelines. On paper the syllabus looks very good. But they are taught by those who have not been fully proficient in their subject. Most of the time, in BSc and MSc, syllabus is not fully covered for want of competent teachers in the colleges. Even to know the full subject they need to teach, they need to be

trained with missing part of the subject they did not study in their degree college days.

Up to 11 and 12 classes, there are text books. It is compulsory to cover all the chapters or full book by the teacher. But at BSc level, uniform standard text books are not produced by Govt. or any agency or Universities. College teachers write these books and students follow them. So, there is no uniformity in the subject that is taught and studied across India. It is difficult to find that full syllabus is covered in most colleges either due to incompetence of the teachers or due to lack of time. Most of the colleges in Karnataka and in general in India, BSc classes are taught by Contract or Guest – faculty with a huge uncertainty of their continuation of service for the next year. In general, quality of teaching is less than the desired because the State Govt. as well as MHRD, Govt. of India have left the college education run by itself. Regular appointments for college lectureships have not taken place in full over 30 years. All the government and government-aided colleges run based on PAID SEATS economy. A student pays about Rs. 60 thousand per semester and money is utilised to pay salary to the contract/guest lecturers. The disparity on the salary of guest faculty of about Rs 15,000 pm against a regular faculty getting over Rs. 1 to 1.5 lakh pm does not excite the guest lecturer. Both are expected do

the same amount of work. Effect of not having proper education at BSc is felt at high school. BSc graduates coming out of colleges where they have not received assured level of knowledge become high school teachers. Since there is no alternative to carry on with high school education, deficiency of the teachers at BSc level need to be filled by providing good training.

For a BSc degree, the science subjects physics, chemistry and biology are covered in two parts: Theory and Experiments. Colleges have moved into semester system. Each semester, 15 experiments are listed but at best 7 to 8 are done by the students. The experiments carried out have very little connectivity with the theory they study. Subject covered in the laboratory lags far behind the theory subjects taught. Experiments do not cover the theory subjects they need to study. Experiments are not updated for a long time. Even the 8-10 experiments are not done by the students for want of facilities and money to buy consumables. Equipment are largely outdated. For example, analogue current and volt meters which are no longer produced are still in use instead of replacing them with digital multi meters. Very little money is available to conduct experiments. In general learning science by doing experiments is story of the past in most colleges. Then how will they acquire competence to teach science? The teachers therefore need to do

experiments which they have not done and which they need to demonstrate to the students. Therefore, they need training.

It is an assumption that if a person possesses a BSc degree in PCM, he is proficient in all the three subjects and can teach the subjects to the satisfaction of at least high school students. He will have a training on how to teach- methodology (BEd) and so becomes more qualified. He is appointed by a selection process. But the basic assumption that he is competent remains an assumption. If he needs to be appointed as a high school teacher, examination on a standard SSLC paper would give answer. It will be considered a retrograde step and not admissible. That is what the Teacher Eligibility Test (TET) is all about. The results are already known that he/she will not score more than 60%. The education system has to run and so there is no alternative to select people who apply and get the best among them. Therefore, teachers appointed need training to fill the gap.

Present method of learning is to engage the students intensely. Unlike engineering education on the IIT patterns, the Degree College and MSc students spend much less time to study. Teachers spend much less time to prepare for a lecture compared to a teacher in an IIT. Methods on how to study and acquire knowledge itself

are not so well taught. It is largely left to the imagination of the individual student rather than the method that teaches him how to learn. The methods that are developed in IIT system are largely borrowed from the western advanced nations, which are proven to give desired results. However, these methods are less known to the teachers at least in science and mathematics in degree colleges. Contact hours are kept idle. Dropping classes is quite common due to lack of teachers. Time allocated for experiments is too large for what they accomplish. At least double the number of experiments can be done in the same time allotted. Experiments –laboratory reports are largely copied generation to generation and hardly checked by the instructors. Results of experiments they do many a time are cooked up. Teachers look the other way even if they find the practice is wrong. Maybe they did the same when they were students. Very purpose of performing experiments to learn science and to verify expected results is lost. The teachers are not exposed to rigorous teaching methods because they have not gone through such rigorous studies when they were students. Competence is not developed by the teachers because they may not know how to acquire competence. Therefore, the direction of learning needs to be changed in BSc and MSc classes. Till grand improvements take place in the Colleges and Universities, teachers who already came out of the

system and started teaching, need training.

Those who score and qualify for PhD do not come for College teaching. Those who can get MSc seats do not come for high school teaching. Those who can go to BSc after 11+12 do not go to primary school teaching. Therefore, in general one level lower scorers become teachers at each level. There are no others available who can be appointed as teachers. This is the reality. In the absence of any process to tide over the present crisis, increasing the knowledge of the teachers by a proper training is the only alternative.

Average intelligence of students in our country is quite high. Given time and proper training, they do become scientists. Students are generally excited to study science. But, lack of correct knowledge among our science teachers, lack of experimental facilities in schools, colleges and universities and lack of experimental skill among the teachers have made our science learning/teaching rather poor. The teachers presently serving in high schools, colleges and universities are perhaps the biggest human resource in the world. Therefore, there is a huge scope to improve science education in India by providing novel training to science and mathematics teachers. Consequently, training science teachers at all levels will bring huge benefits to young students and raise science education level at each stage.

Intelligence and level of uptake among the population obviously follow normal distribution. While some care can be given to students who are deficient in learning, individual attention is difficult considering the numbers to be handled. As it stands, books and syllabi are prescribed and they need to be faithfully covered. Educational system does take care of all the logistics of classes, examinations, attendance of teachers and students, guest faculty and so on. While a functional system is in place, it is the quality of learning process that warrants greater attention. Given the present educational system, what can be done to raise the level of learning science and mathematics can be addressed effectively by raising the competence of teachers. This is evidently an effective route to make the new generation knowledgeable and make them contribute to progress of the nation.

Advantages of training teachers

As mentioned earlier, the multiplier effect of over 1:100 every year is the overriding consideration. Teachers are already selected and appointed. The teachers' training centres do not have the responsibility of finding jobs for them. In turn, they are already committed to their profession. They are generally aware of what they do not know and what they need to learn. Having been in service they appreciate

the demands of teaching. They serve in their schools or colleges for 30 to 35 years. Therefore, they have intense desire to learn to save their prestige in the class rooms, schools and society. From our experience it is well established that almost all the teachers want to learn, ready to undergo rigorous training and subject themselves to pre and post-tests. Many teachers are competent but some are not, but self- assessment of their competencies rarely attempted. But they have enough talent and they can be induced to become more competent teachers by well-designed content enrichment-oriented training. Teachers are already introduced to the subjects and so they are able to grasp and understand subjects faster than students as proved experimentally in TDC by teaching students and teachers together at PU level. Top 1% of students from Manipur were taught along with the teachers the same science program. This experiment revealed that the students were not at all able to learn in a shorter time. It further unveiled that for this reason only, high school students need three years to learn the subjects prescribed in the books. The teachers can pose their doubts and seek clarifications with precision. When clarifications are provided, it takes very little time for the teacher to assimilate them. Mature mind makes it easier to appreciate the subjects better than the uninitiated.

Teachers' Training – Present Status

Eligibility for a high school science teacher post is BSc PCM with BEd or BSc CBZ with BEd qualifications with minimum of 50% marks. BSc PCM degree holder teaches mathematics and BSc CBZ teacher is supposed to teach entire general science subjects for 8, 9 and 10 classes. In some schools, they also teach 6 and 7 class students. BSc degree is based on the subjects/syllabus prescribed by the UGC. BSc is a broad based 6 semester UG degree. BEd is one-year degree course. BEd course content is largely on education methodology with wide ranging syllabus including pedagogy. But the syllabus does not include the contents in science and mathematics which they have to teach. Contents of 8, 9 and 10 class books are not part of the syllabus. They are assumed to have full knowledge of 8, 9 and 10 class text books since they have BSc degree. Therefore, BEd is not a content or subject knowledge enriching degree beyond the knowledge the teachers possess from their BSc degree.

National Council for Education, Research and Training (NCERT) is the nodal agency to plan teachers' training in India up to PU level. NCERT is an autonomous organisation of the Govt. of India established in 1961. NCERT is formulating curriculum and bring out text books from 1 to 12 classes. Textbooks published by NCERT are prescribed by the Central Board of

Secondary Education (CBSE) from classes 1 to 12. Govt. of India wants all the state boards should adopt CBSE for uniform education in India. Karnataka Govt. has adopted CBSE – NCERT books in full up to 12 classes. Those who wish to adopt the textbooks are required to send a request to NCERT, upon which soft copies of the books are received. As such, NCERT do not conduct teachers' training program and their main occupation is curriculum and text book development.

Regional Institutes of Education (RIE)

The Regional Institutes of Education (RIEs) located at Ajmer, Bhopal, Bhubaneswar Mysore, NE-RIE Shillong are expected to provide educational needs (preservice and in-service education) of teachers/teacher educators in the States and Union Territories under their jurisdiction. But they conduct extremely small number of training to a small group of teachers and for all purposes, training is only in name. Further, RIEs are busy in teaching their own BSc Ed and MSc Ed students. No doubt, the RIE BSc Ed and MSc Ed courses are good. That is why most of their graduates go to research leading to PhD instead of taking up teacher's job. Therefore, the purpose for which RIEs established is not fully served. For all purposes, high school teachers of Karnataka do not come to see RIE Mysore and get trained.

DSERT- Directorate of State Education, Research and Training

The Department of State Educational Research and Training, popularly known as DSERT is the academic wing of the Department of Public Instruction. It aims at providing academic training to the primary and secondary schools teachers in the state. The Directorate of Text Books was attached to DSERT in 1983. The National Policy of Education 1986 gave special importance to teacher education with special emphasis on giving quality training to primary school and secondary school teachers. District Institutes of Education and Training (known as DIETs) were set up one in each district of a State. The objectives of the DSERT are:

- a. To provide academic leadership in school education in the state.
- b. To achieve qualitative improvement in school education through teacher training.
- c. To promote Action Research in order to facilitate teacher development.
- d. To undertake academic reforms in the light of policy changes by the state.
- e. To coordinate at the state level, schemes of various state, central and international agencies – NCERT, NIEPA, UNICEF, SSA, RIE.
- f. To undertake various projects in the field of education in

- collaboration with various agencies working in the field of education including NGOs.
- g. To administer teacher education in the state,
 - h. To act as a nodal agency in providing in - service training of both primary and secondary teachers.
 - i. To prepare teachers' hand books, resource books and other materials for use of students and teachers.

DSERTs are supported by Sarva Shiksha Abiyan (SSA) and Rastreeya Madhyamika Shiksha Abiyan (RMSA). DSERT undertakes large number of initiatives to promote education in a State.

While the institutions are in place, quality of training they offer itself is not considered up to the mark by high school teachers. This is because the trainers are of the same cadre as those of high school head master. Diet College teaches' basic education degree in subjects is BSc CBZ or BSc PCM. Both BEd and MEd courses do not have subject contents (Mathematics and Science of 8, 9 and 10 text book subjects) as part of their syllabus. It is assumed that students of BEd and MEd courses have full knowledge of the subjects they teach in high schools. The assumption is not correct as pointed out earlier in this chapter on why teachers need training to enrich subject content. Without

the subject knowledge, method of teaching will not help to teach the subjects. DIET college teachers' knowledge remains at the level of high school teachers. Therefore, lack of adequate knowledge and competence in science and mathematics subjects do not instil confidence among the high school teachers and so training is found less effective.

All the DIET college science and mathematics teachers and science and mathematics subject inspectors (SI) of Karnataka were invited to undergo a 10 days training program here in TDC in October 2016. DSERT Director insisted that they should be trained in TDC. Their performances were far below the regular science and mathematics teachers of high schools in the pre and post training tests. This is possibly because they do not teach regular classes to make students pass SSLC unlike the regular teachers. Their work culture and interest to study is far less than desirable, certainly less than the regular teachers. They found it difficult to do experiments and generally not interested. They were walking much slower and average body weights were much higher than teachers. Several professors who were teaching them noticed this and we in TDC discussed why it is so. It turns that they do not work as many hours as the teachers themselves and they do not stand four hours in the class teaching mathematics or science. Therefore, the DIET colleges have not been

effective to impart desired science and mathematics training to high school teachers. This is the general opinion of the high school teachers who have come for training in TDC. After a training in TDC, the Diet College teachers accepted that they cannot give good training which enriches knowledge needed by the teachers. This is one of the reasons why teachers' training has bad name and disliked by almost all the teachers. Since they have to attend the Govt. DSERT program, they attend but learning component is sub minimal. In addition to this, large part of the training goes for functions to garland dignitaries. Time available for training itself is 3 to 4 hours a day. Unlike our training program, they are not residential training program. Only attendance is important. To make the teachers overcome bad opinion on "Teachers' Training" and get engaged seriously in our training program, it took a long time for TDC.

Not that there were no efforts to improve DIET Colleges by the Govt. The Central Govt. gave through RMSA/SSA Rs 15 lakhs in 2016 to the DIET College, Chitradurga to make improvement in the teaching. I was made a member of the committee. We suggested to see that the college be equipped with 8, 9 and 10 class laboratory experiments costing 1.5 Lakhs. This was passed by the committee. Since the Diet College and the BEd govt. college are situated close to each other, the experiment kits could help the BEd teachers to teach

the BEd students. However, the money is spent and no experiment kit was bought! Money given is not utilised for the purpose for which it is given. None the less money is spent fully. Second meeting never took place.

ZIET: Zonal Institutes of Education and Training

To train Kendriya Vidyalaya school teachers, Govt. has instituted several ZIETs. These institutions are run well and they organise training program only for KVs for teachers teaching classes below 10 as well as 11 and 12 classes. If ZEITs engage in teachers' training to State teachers it will have a huge impact.

PU Dept. Training programs

Karnataka has over 600 Govt. PU colleges and the PU department conducts content enrichment training program for 3 to 5 days. Generally, local college teachers are invited to give lectures. The program is mainly class room teaching without laboratory experiments to learn science.

UGC refresher Courses

To enrich College and University

teachers, University Grants Commission established Academic Staff Colleges in each State. The training program is largely based on 6 hours of lectures for 18 working days or three weeks – 21 days program. They do not have laboratory programs. Visits to the laboratories is arranged some times. Courses are not rigorous and content enrichment is not considered satisfactory. In a later chapter, we will deal with UGC refresher courses in detail.

In view of the multiple reasons cited above, we conclude that, teachers at all four levels need training and higher knowledge. Enriching the teachers with required knowledge is the best method to enhance the quality of teaching and learning at all four levels. Knowledge Commission, Govt. of India, came to a conclusion that training teachers is essential to raise level of learning. In its report, a National Commission for teachers' training was recommended in 2009. Pandit Madan Mohan Malviya National Mission on Teachers and Teaching (PMMNMTT) under MHRD in 2015 is the outcome of such a recommendation. National Education Policy document submitted to Govt. of India headed by Dr Kasturirangan contains details on "why students receive lower level of education?". NEP has recommended teachers' training to provide quality education in India.

High School Science and Mathematics Teachers' Training at TDC

IISc conceived a working plan to train teachers at all the four levels to improve the quality of teaching and learning starting from High Schools, PU, UG Degree Colleges and Universities. Basic science subjects such as physics, chemistry, biology and mathematics are covered. This was a major program that was conceived as part of its social commitment to society. We were convinced that quality of education received is far from desirable at all the four levels. Parents started moving out to put their children to private schools from Govt. schools for two reasons. One, quality of education in Govt. schools is perceived to be lower. Second, the parents wanted their children to study in English medium schools. Today, 65% students are in government and government-aided schools and 35% are in English Medium private schools. Good number of Govt.

Schools have started English medium schools and they are now attracting more students. Teachers' training is a necessity to provide quality education both in public and private schools. Since IISc is a Govt. institution, it was obliged to worry about government and government-aided schools and colleges. Question was how to arrive at the best possible training program?

The education system as it exists is taken as available for improvement. All the teachers are in place in the respective schools. Schools, Colleges and Universities are all running. Major advantage to train the existing teachers is that **(a)** they can be sent to training by their respective institutions. **(b)** IISc need not worry about their employment. **(c)** Infrastructure for the teachers to improve the education already exists. **(d)** Responsibility of

IISc is to train the teachers so that additional knowledge they need is provided. Therefore, what the teachers need for them to be good teachers is to be assessed at each level of learning.

What are the present problems in High School Teaching in Karnataka?

Science teacher does not teach full science book. There are over 8000 government or government-aided high schools in Karnataka. Nearly 7000 of them are single division 8, 9 and 10 classes with about 30 to 70 students in each class. These single division high schools are mainly in the rural areas. Each of the high schools is surrounded by four to six full primary schools. These high schools have 7 teachers- Head master, Science, mathematics, Social Science + Physical Education, English, Kannada or local language and Hindi or Sanskrit. Mathematics teacher has a PCM BSc BEd qualification and Science teacher is CBZ BSc BEd and others are all BA BEd. Among the subjects Mathematics, Science and English are perceived as difficult to teach and also difficult subjects for the students. If a student does not pass in SSLC, it is because of low performance in one of these three subjects. Also, anybody is found good in mathematics, he is generally good in all other subjects. Passing depends mainly on passing

in mathematics paper. If a teacher is not able to teach well, the school is dead for the students till he retires. Therefore, every teacher is important and he must be made competent to deliver.

Although, science teachers having a BSc degree in chemistry, Botany and Zoology with mathematics and physics in PUC, they are considered weak in physics. This is only a perception. CBZ teacher is qualified to teach full science book because to qualify as science teacher he/she need to have taken PCMB in PUC. In fact, in more than 50% of schools, the science teachers do teach full science subjects.

All the teachers need to have 24 periods of 40 min. work load per week. Science and mathematics subjects will have one period each of the six days in a week for 8, 9 and 10 classes. PCM teacher teaches 18 periods of mathematics per week. CBZ science teacher also should teach 18 periods of science but he/she is considered weak in physics and so teaches only 12 periods and leaves 6 periods to PCM teachers. This arrangement creates an imbalance in the teaching load where PCM teacher gets overloaded. Therefore, science teacher should teach full science books in high schools. He should be made confident to teach physics.

In towns and cities government and government-aided schools have two to

three divisions in 8, 9 and 10. They are big schools. Composition of science teachers now will be two teachers with PCM and one science teacher with CBZ qualification. In these multi division schools, science is taught by both PCM and CBZ teachers.

Science should be learnt with lots of experiment demonstrations in the class room. Even though a large sum of money is spent for schools under RMSA, schools are not properly equipped with experiment kits. If there are some experiment kits, they are of low quality and may not be in working condition. A visit to a high school gives the evidence to this fact. Lot of equipment not in use for a long time is essentially junked.

Most schools do not have a separate laboratory. Science is learnt on the black boards. All the schools were to have proper black boards/green glass or metal polished boards. Under RMSA way back in 2002 to 2004 "Operation Flood Black Boards" were sanctioned. The implementation is scanty even though money for it is spent. Good black boards are not in place in many schools. Students cannot see legibly what is written on the boards.

Teachers themselves have not performed experiments/demonstration prescribed in the NCERT books under 'Activity'. Even if the experimental facilities are available, teachers are not experienced to carry out the activities.

Teachers are also not used to carryout demonstration/activities in the 40 min. period combining the subject they teach and the experiments.

Assignment writing and completion be it the exercises/problems at the end of a chapter, or new questions on their own, are not insisted by the teachers. More serious fact is the correction of assignments and giving back in time is less practiced. At the end in SSLC, the students have to pass a written examination and so writing correct answers and approval by the teacher is a must.

Honesty component in teaching to understand science should be very high. Facts have to be correct. Teachers should not accumulate doubts. Further, reading habit among the teachers is less than desired. Preparation before going to classes or previous day is practically unheard among the high school teachers.

Teachers are prone to put more effort mainly in 10th class. Teaching the full book prescribed at 8, and 9 is not practiced. Seriousness of teaching in 8 and 9 class is far less than 10 class. Making the students to fully learn what is in the book is a must. If the teachers have not made the students learn the full book in 8 and 9 classes, students find it difficult to cope with class 10 subjects.

Habit of giving part-marks in the class

tests is a serious drawback. This will not make the students competitive and they will never try to score 100%. Attitude of making the students just pass ultimately makes the students fail. This has also lowered teacher's knowledge. Generally, students write whatever they know and the SSLC examiner – paper evaluator has to search something that is correct and give marks to pass the student. Writing exact answers to a question should be inculcated from 8th class itself. For this to happen, teacher must be knowing correct answers.

Entire education system in Karnataka is geared to make the passing percentage high in the first public examination that is SSLC. 20 marks are reserved for class marks and students have to score 28 out of 80. If the score is 24 out of 80, he/she can borrow excess marks from other papers. Question paper is so designed that about 10 marks can come from multiple choice answers either on his own or help received in the examination hall. Teachers are essentially forced to give maximum 19 to 20 for the class marks. As long as passing percentage is high, all the people in high school education are safe in the eyes of the Government. This does not help the students to go further to PUC and pass there. An extra effort on the part of teachers is needed to make the students learn and pass the examination honestly without copying.

Copying was rampant to increase passing percentages. A unique method was discovered namely writing the answers on the board in the examination room and if the student can re-write in the answer book what is on the board, he passes! This method discovered by the teachers /schools had tacit support of headmasters and BEOs and the DDPIs. The method was popularly known as BOARD EXAM. This has lowered the morale of the honest teachers and also honest students. In the last few years since 2015, efforts have been made to reduce copying by installing TV cameras and also making supervision stricter by teachers of other subjects by the Govt. Yet, the decrease of copying to make the students pass has not been fully cured.

Genesis of copying practices in many districts such as Chitradurga is mainly due to teachers not taking classes regularly in addition to lack of knowledge. Extreme poverty in this district can be gauged from scanty rain fall. On an average, farmers get one ground nut crop every three to four years. Sheep breeding, 10 to 15 by a family, is the main source of income, just keeps the family alive. School teachers are the only ones who get cash-money every month. They support the villages by lending money. Most teachers thus became money lenders. Dynamics of money lending and related methods to sustain and recovery perhaps required time to be allotted by the teachers. Whenever a teacher is not found in

the school, a visitor is told that he has gone for a meeting. Out of 18 visits to a nearby high school, only on 4 occasions the head master was found in his office and on other 14 times, he had gone for a MEETING! It may not be a bad economic proposal under bad circumstances the villagers are to live in. It is not necessary to find fault or look down upon this engagement by the teachers. But effect of this was lower priority to teach and make the students learn for which they are employed by the Govt. After all the money for lending comes from the Govt. for teaching the students.

A large proportion of the teachers has to come out of the above system. Therefore, the training the teachers for knowledge is one part. To make them honest teachers is a more serious part. It is the less competent teachers who are less honest and therefore aiming to increase honesty in those teachers is a more serious requirement than mere academic exercise of training to enrich their knowledge. Generally, such ethical and integrity issues are known to most in the State Education System but never accepted in open and discussed in public. Writing the facts like this is considered impolite. Such issues are not written in print except occasionally in newspapers which are forgotten immediately after reading. If the teachers are fully knowledgeable and competent, most of the above problems gets solved on their own. The issues raised above have emerged

during discussions with teachers.

Finally, the real problem of lower level of learning by the students is lower level of knowledge itself. Increasing the knowledge of teachers to the extent required to teach the students at least to full text book level is the main issue.

How the training program addressed these issues

Invite 60 mathematics (PCM) and 60 science (CBZ) to TDC for 10-day residential training. Science teachers are weak in mathematics and find it difficult to teach physics in particular. Teachers have poor appreciation for numbers. Therefore, they are given lessons in mathematics required to solve high school physics problems. Then they are trained in physics for five days which include three hours lectures with demonstration, 6 hours of laboratory experiment each day. Laboratory experiments involve observation, measurement and verification. Instructors with MSc or BE degree are provided to help doing experiments. The subjects covered include sound, optics, electricity, magnetism, mechanics and other topics. Experimental kits have been specially designed and developed specially to carry out with less time and get accurate results. Teachers are made to record the experimental

observations in the laboratory book directly, leaving no scope for fudging results. This practice is earnestly insisted to be followed to get rid of fudging results. Honesty starts when they start writing the results of any experiment. In colleges, they practice copying the experiments from previous batch of students. Almost all the laboratory note books are copies of each other and this is hardly checked by the Instructors. The habit continues and learning honest reporting of the results they observe were killed when they were students. In TDC, completion of experiments is monitored and approved by the instructors. Over 30 experiments are done in physics which are the activities in the books. Remaining 30 experiments are demonstrated in the class rooms. Teachers are given one assignment each day evening which they start solving after tea break and submit for correction. The assignments are corrected and returned in time. Most of the time, individual teacher is called and corrected his/her assignment in their presence. During the lecture, problem solving is introduced and individually monitored. All the subjects in 8, 9 and 10 classes are covered in the form of a course during the training program.

Teachers are taught chemistry in two days covering subjects in 8, 9 and 10 text books. Special assignments are designed on how to write chemical formula of compounds, electronic

configuration of atoms and ions in a compound, drawing periodic table, relation between quantum numbers, and the rest. They are made to do over 50 experiments in the laboratory. Almost all the chemical reactions given in the books are performed by them. They write balanced chemical reactions for over 50 reactions. Whatever is written by them are checked, corrected and given back. The main effort and emphasis here are to teach what the teachers do not know and what they must know.

Similarly, they undergo two days of biology training which include extensive experiments required to learn biology part in their science books. Use of binocular microscope, organisms in a pond water, identification of species, growth of bacteria, fungi, isolation of DNA, separation of DNA and Proteins by electrophoresis, blood group analysis, blood pressure, and many which are part of their text books are part of laboratory experiments. Most of these experiments have not been performed by the teachers in their PU or BSc and they get to learn all these in TDC. Science teacher does over 100 experiments in 10 days and observes over 50 experimental demonstrations in the classes. The teachers will write one assignment in the evening every day. Disconnect between laboratory experiments and theory is bridged by making them write answers based on the experiments they did. This

particular step makes them understand theory behind experiments. Teachers are not given part marks during the test they appear in TDC. Writing correct answers is insisted so that they can practice it in their schools.

Training for PCM (Mathematics) teachers has a separate schedule. All the ten days they learn mathematics. A lecture for 60 min to 90 min is followed by 10 to 15 problem solving associated with the lecture that was just taught. During the problem-solving session, TDC teachers/tutors are available to prompt/assist them to solve the problems in the class room itself. They have to sit in the class room only and write the assignments and not in the night in hostels. They cannot just copy and submit assignments. Everyone is monitored and helped to learn how to solve problems, how to write answers fully and correctly. After completion of solving one set, each one needs to take signatures from the tutor for completeness and correctness. In the morning at 8am, 30 min. test is given on the subject learnt the previous day. No part marks in mathematics- to make the teachers to learn how they can train students. Each of the test papers is solved on the board by the instructors. Those who score less than passing marks are called in the evening and make them rewrite the paper again after they have been solved on the board by the tutors. In the 10 days of mathematics training the teachers solve over 500 problems

covering all the subjects in the text books. Problems given are of the same level of the books and also from the books. At the end, they should be able to solve all the problems in the books. It turns out that most among the teachers have not solved the problems given in the exercises in the book itself. The training program compulsorily make them solve the problems, repeat them to solve similar problems by way of revisions.

All the topics in the 8, 9, 10 class science text books are taught and learnt through experiments. New experiments are designed here in TDC to make the theory concepts simple. Experiments are also made simple to perform in a shorter time by choosing digital equipment and simplifying the method in each case. Experiments include measurements of density of solids, liquids, ideal gas law, photoelectric effect, optics and radiation, emission spectra, diodes, transistors, chemical estimation, water splitting, chemical reactions, preparation of gases, determination of Avogadro number, identification of microbes, growth of bacteria and fungus in the lab, blood test, urine test, pregnancy test, HIV test and extensive use of microscopy in biology experiments.

Excitement of doing experiments was the key to make teachers interested in this training. For the high school teachers, the experiments were new

yet within the text book. They have been teaching the theory behind the experiments but they have not done the experiments themselves. Therefore, there was an instant appeal and excitement to carry out the experiments. Now many teachers are saying that the RMSA under MHRD fund can be utilised to implement the experiments in their schools. We have shown to the teachers that they do not need elaborate laboratory to do the experiments and only the class rooms are sufficient. Also, for many demonstrations, small apparatus like spirit lamp, etc. are sufficient. Time required to do an experiment involving a concept is just about 30 to 40 min. This can be done in the science class period of 40 min. The same concept in the lecture is covered at best in 10 min. Application of mind, direct observation of an effect and more time available to grasp the subject while doing experiment, deriving numbers from experimental data, verifying the observed data with those of reported in literature – all put together makes them learn the subjects correctly and more easily. Many of the concepts are also taught with demonstration experiments in the classroom during the lecture.

The above methodology is not newly discovered here in IISc. World over, science is taught this way. However, in India, due to factors such as large number of students in classes, lack of space and laboratory facilities, lack of knowledge and skill among teachers,

less conscious demand for quality education, attitude of making the students just pass, parents education level, lack of proper resources have made our science education uninteresting and less inspiring. Our training comprehensively reverses all these problems and instils confidence in the minds of teachers.

Guiding Principles for High School Teachers' Training

After studying the problems which the teachers faced, the following criteria were adopted for high school teachers' training.

- a. Learn Science by doing experiments.
- b. Learn mathematics by solving problems.
- c. Create new experiments to learn principles.
- d. Black board lectures with demonstrations.
- e. Simulate teacher's school environment in TDC.
- f. Assignment writing in the class, submission in time.
- g. Correct/grade the assignments and return in time.
- h. Teach the teachers what they do not know and
- i. Teach what they must know within text books.
- j. A pre-test to find "how much they know?"

- k. A post training test to find "how much they gained."
- l. Train every teacher how to think and work hard.
- m. Make every teacher knowledgeable and honest.
- n. Respect the teachers and take them into confidence.
- o. Make the teacher confident to teach the subjects.
- p. Make every teacher teach correctly and honestly.
- q. Make the students learn and become honest citizens.

Specifically, using power point presentation for a lecture is bad for learning at high school level. Reasons for this are: in a slide there are too many information/facts and students/teachers will not know which one to pick. In other words, eyes cannot focus on all the information. But when one writes on a clean board, attention is on what is freshly written. It then becomes focused learning. Further, rate of understanding or reading is restricted to rate of writing. Whatever is written by the teacher must be fully learnt by the students. Also, this is exactly what they do in high schools. World over, power point presentation up to Colleges is banned or at least discouraged.

All the students have to pass through a written examination. The written answer paper is evaluated. Therefore, making the students write correctly is the clue. That is why teachers need

to practice themselves write correctly. That is why assignment writing and correction/grading correctly and giving back is a serious part of teacher training. Since the teachers have not gone through such a rigorous method, they need a training.

Self-evaluation is essential. That is why test for the teachers is essential. It is common to note that teachers are prone to copying. Psychology and habit of copying stems from not knowing the answers. Therefore, the fundamental for most of the ills in teaching is inadequate knowledge among the teachers. This must be driven into their mind.

It is not true that the teachers are unaware of their problems. Most of them did not have opportunities to learn from the best and learn properly. Going down to their level of understanding and start making them learn the subjects is essential on the part of the trainers. Looking down on them has a huge negative effect. On the contrary, the teachers are ready to put efforts if you take them along and convince them that they must learn what they do not know. This is obvious for those who have gone to good schools but it is not obvious to those who were denied leaning in good schools. Most high school teachers come from the latter category.

Most high school teachers have not studied in a residential atmosphere.

They have not had even a mild dose of ragging self introspection. They are shy or hesitant to open their mind. They are hesitant to tell they do not know a particular subject. As soon as you give back the answer papers of a test, they fold it lest other person sees. Does not know what the bench mate scored same low-level marks. They are feeling insecure even if they are reasonably good. The residential training therefore makes a lot of difference to overcome these issues. Completely open atmosphere in TDC slowly makes them find themselves. They start learning from others.

High School Science experiments

Experiments which are essentially the activities in the 8, 9 and 10 class science text books have been designed and developed here in TDC. In addition, experiments to understand the content in the books have been designed to make the teachers understand the concepts. New experiments have been designed, fabricated, multiplied and used for the training. Two teachers form a group or batch, selected from alphabetically arranged list, so that two good and two not-so-good teachers do not become partners. This method encourages leaning from each other. A demonstrator or tutor with a minimum qualification MSc or BE teaches how to do the experiments. Each group performs all the experiments one after

the other. Many a times, experiments are done independently by a teacher. Calculations are done individually by every teacher. There is no rough data entry as followed in their BSc career. All the data are to be entered in the laboratory note book once and for all. Chances of fudging the data is fully avoided. This way we induce honesty. Completion of the experiment is verified and approved by the instructors. 80% of the experiments are new, designed in TDC and fabricated, produced now by companies.

When we say experiment, there should be a result quantifiable. For example, resistance of a metal. Density of a solid. It may be surprising to the reader that out of over 9500 high school teachers who have passed through the TDC, not even 10 had actually measured the density of any solid. Most of them are not knowing the numerical values of densities of most common materials such as aluminum or iron. Unit of density – SI and g/cc is vaguely known to a few. Density of water is 1 g/cc they remember but it is at 4°C is known only to a few. Most schools have not got a digital balance. This is the level of most of our high schools. Therefore, a strong experimental base for learning science is absolutely essential.

High School Physics

Well-designed lectures are given to the teachers with demonstrations and class work requiring to solve the problems. Experiments covering 8, 9 and 10 class text books have been designed and each of the teachers performs these experiments during the training program. Most of the experimental kits are not available in the market. The experiments are designed, developed, checked for reproducibility of results, accuracy of the result, duplicated and finally multiplied via entrepreneurs. Care is taken such that the results they get agree with the literature/books. Only when the results match with the expected values, teachers appreciate the experiments. This is a tall order. During the training, they cannot do too many repetitions. With one experiment they should get accurate values. Concept of repeat and confirm the results, need to repeat and get accurate results, sources of experimental errors are not yet understood by the teachers. Accuracy up to one decimal place, two decimal places is also not clear to the teachers. During the time they spend doing experiments, tutors explain all this and make them understand why experiments are important. This aspect cannot be learnt by reading books.

The experiments are covering the subjects they need to teach. Experiments cover over 90% of the

contents in the books. This gives the confidence to the teachers. Experiments are made simple so that the teacher can do these experiments in the class room. In the high schools, it is perhaps not feasible for individual student to perform experiments. However, students have a chance to see all the experiments how it works. Curiosity is created by the teacher to study science. By adopting digital equipment, time taken for doing experiments is reduced. Accurate results required at the level of high school are obtained and experiments are verified as it should be. For example, digital balance, digital Vernier calipers, digital multimeter to measure current, voltage, resistance, digital pressure meters are some of the instruments introduced to them. They have not used such measuring instruments in the past.

Experiments should give definite results – a number at the end which should be distinguished from Demonstrations. Demonstrations are equally important. Seeing is believing. A stone and a piece of iron, approximately of same size and shape when held given to the students form a demonstration towards understanding density. This will lead to determination of density- an experiment. It will look trivial for those who know. But that is the basis of learning science.

Instructors/tutors are assigned the job of taking care of each experiment.

Completion of the experiments by teachers is certified by the instructor. All the experiments are compulsory and have to be completed in a limited time. In addition to the experiments the teachers do by standing in the laboratory or in the class rooms, teacher carries out several demonstrations which are not listed. If the experiments are performed by standing, time taken is less. There may be apprehension whether the teachers can complete all the experiments in stipulated time. Yes indeed, it is possible due to a well-organised working system to ensure each teacher completes all the experiments. Since they are teachers they do experiments faster. TDC is equipped with 10 to 15 sets of each experiment. A list of experiments a high school teacher performs in the training is listed in the appendix A. These 50 experiments are part of Physics Experiment Manual for the training. Indeed, such a booklet "High School Physics Experiments" is given to the teachers. This manual has elaborate description of each experiment, procedure, result table, formula, how to do the experiments. Brief description on experiments are included for the readers of this book in appendix to highlight what it takes to make the training interesting by introducing experiments to understand theory. This is also a part of research in science education and development in TDC

High School Chemistry

The science teachers with CBZ background had chemistry in their BSc, and in only two days, chemistry part for 8th, 9th and 10th class is covered. Subjects which are difficult for the teachers are covered in the lectures. In four lectures, atomic structure, electronic configuration of atoms and ions, oxidation state, valency, electrovalent compounds, covalent compounds, chemical formulae, mole concept, chemical equations, organic compounds are taught with extensive demonstrations. Class work is designed so that teaching and writing is conducted together. Drawing periodic table, how to write elements with configuration in the periodic table, method to write electronic configuration are practiced by the teachers in the class. Well thought out assignment is written by the teachers in the class room. The same assignment with extended examples is given again in the evening. They will be doing over 50 experiments small and big in the laboratory. The experiments are so arranged that all the teachers are able to do all the experiments. In all they will spend 8 hours in the laboratory. The experiments done are described in High School experiments in appendix. Experiments cover almost all the chemical reaction, concepts such as mole concept, water of crystallisation, crystals and growth, determination of Avogadro number, electrolysis, fractional distillation, preparation of

gases and their properties and so on. Teachers after doing each experiment write their observations, chemical reactions, derive results all of which are checked and corrected by the tutors. Two days are intensive because we need to see that the entire subject is covered. Since they have some experience, they are able to cope with it. They are also provided a Chemistry Manuel describing all the experiments and assignments. They can carry them to the schools to teach their students.

High School Biology

Similarly, they are engaged for two days studying biology. We provide them binocular microscope individually to make observations. They do over 50 experiments in biology listed in the High School Biology experiments in the Appendix. A large number of experiments are new to them such as DNA separation, blood group analysis, blood pressure measurement, identification of various types of cells, staining experiments which are all there in their text books. Teachers enjoy doing experiments. It is difficult to conduct tests in biology. We have devised questions such as fill in the blanks – over 400 of them covering full books. Exact answer thus can be elucidated from the teachers. In 9 days, teachers are given a comprehensive training covering full high school science text books.

One Day in 10 days of High School Science Teachers' Training at TDC

It may be worthwhile to narrate how one day is spent in TDC by a batch of 60 High School science teachers undergoing 10 day training. The subject covered is general science – heat and related topics. Instructions to the laboratory assistants are given the previous day – HEAT is the topic. They arrange all the demonstrations and laboratory experiments for the class room as well as in the laboratory.

The day starts at 8 am. Most teachers are inside the class room. Professor enters the class. He is greeted by the teachers: standing in their respective places.

Q: Good morning. Please sit down. Have you had tea at 7 am? Was it hot enough?

Q: How did they make tea? How did they produce heat to make tea?

Answer generally is: heat is produced by friction. How much heat is produced by friction? Can you make tea by the heat produced by friction? Now the answer is –Heat is produced by burning fuel.

Demonstration 1: Take half A4 size paper and light it. Both heat and light are produced. Is heat is light? Is light is heat? We will eventually answer this at the end of the day.

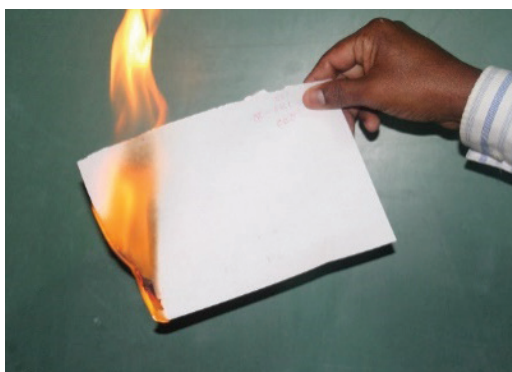

Demonstration 2: The other half of A4 paper – roll it into a stick and light it. It is not burning and gets extinguished. Why? Open the rolled stick, it catches fire. Now explain surface area is more, all parts of paper gets air/oxygen and paper burns. Class has started off well and all are attentive. More expectations!

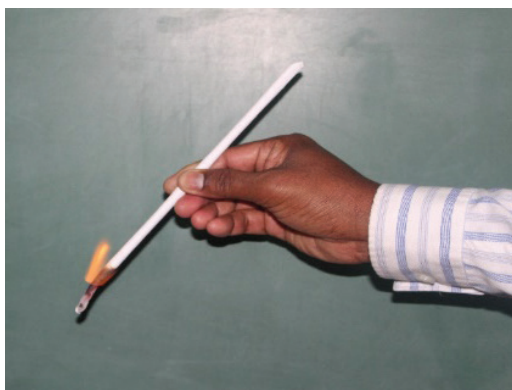

Input to the teachers: Ask the children to collect and bring them to the class, a variety of 20 to 25 fuels used to generate heat for various proposes. Make the students write the correct names of the fuel. Cost and availability, freely available fuel in villages, quality of fuel, – a good activity for the students.

Demonstration 3: Give one cube of ice to each and ask them hold it till they can. Collect the ice cubes.



Q: What did you feel?

Ans: Cold. Why? Heat flows from hand to ice cube and ice melts.

Demonstration 4: Light two spirit lamps and ask two teachers to carry the lamp to all the teachers, show them as if an ARATHI or a candle is going around people. Fire is god. Teachers show respect to flame. Feel the heat from the lamp.



Q: What did you feel? Hot. Why? Flame is hotter than palm. Heat is felt by palm; some will say: heat flows from lamp to palm.

Input to the teachers: They can do this in the class with some planning. Ask the teachers note what they can carry from the demonstrations to their schools.

Q: How do you measure which is hot, which is cold compared to Your body? Thermometer. Mercury thermometer, Laboratory Thermometer. Show the thermometer.

Q: How a thermometer works? Thermal expansion of Hg in the bulb Leads to rise in the mercury level in the capillary. How to calibrate? Not so sure how to do.

Demonstration 5: Show how to calibrate the Hg thermometer.

Put the thermometer bulb in ice. Show 0°C mark. Put it in boiling water- show mark near 100. Where should you measure to get 100°C ? At sea level? Water boils at 100°C at sea level.

Definition of boiling point will be explained. Boiling point of water is lower than 100°C if the place is at a higher altitude is the bonus from this demo in addition to calibration. Thus, the thermometer is calibrated from 0°C to 100°C . At each point, definitions, information have to be written by the Professor on the board. Emphasise

writing answers correctly is important both for the teacher and students.



Q: What is the highest temperature Hg thermometer can measure?

Out of 3500 science teachers hardly 10 to 12 knew – up to boiling point of Hg. But none knew 357°C is the boiling point of Hg. Idea of laboratory thermometer to measure 0°C to 360°C is not known to them. This is not surprising because they would not have used it in the laboratory. Boiling point (BP) of any oil is not known to them. This part needs to be taught. Show them the thermometer; if possible, show BP of edible oil.

Q: What is the temperature of spirit lamp? They would not know. But they do come across temperatures in the book like 1200°C in blast furnace to make iron. Introduce a digital

thermometer with thermocouple, new related knowledge useful to the teachers. General science.

Demonstration 6: Working of a thermocouple.

Explain how a small voltage in mV range develops when thermocouple is heated. Use of Digital Multimeter: – what it can measure (voltage, current, resistance, etc.) is already taught to develop skills among the teachers as part of electricity and magnetism subject in the book. Put the K type thermocouple in ice. You will find reading –(Minus) 1 mV. Difference in temperature from room temperature to ice is approximately 25°C. Calibration: 1 mV = 25°C. Thermocouple wires are alloys; composition: Chromel is 90% Ni + 10% Cr; Alumel 95% Ni, 2% Al, 2% Mn and 1% Si). Show how a junction of two wires is made. And how it looks and works.

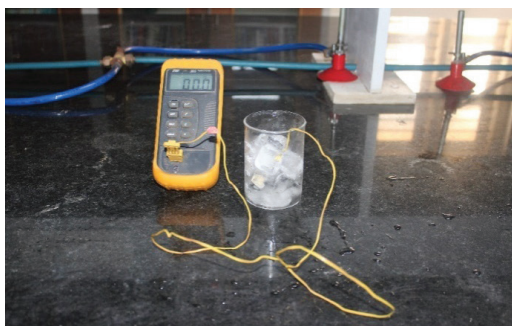

Demonstration 7: Measure mV developed in a thermocouple with a spirit lamp; 30 to 32 mV. Means about 750°C to 800°C; the same sensor can also measure 1200°C to 1400°C.

Introduce Pt₁₀₀ resistance thermometer: They would have measured resistance of Cu coil as a function of temperature in the electricity class. Use that idea to teach how increase of resistance as a function of temperature of Pt metal is employed to measure temperature from –196°C to + 600°C.

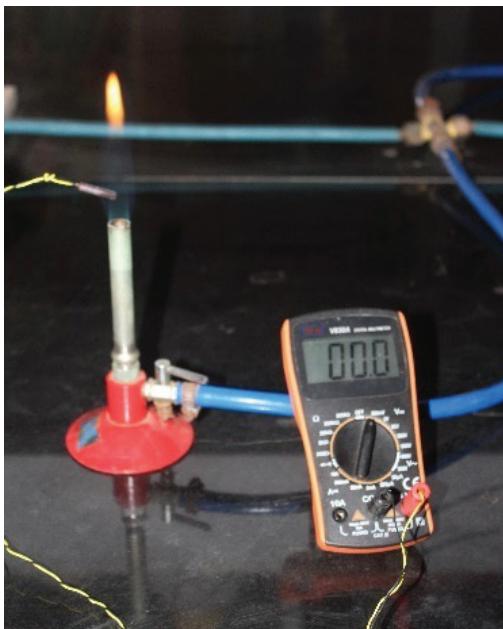

Demonstration 8: R vs T of Pt₁₀₀ in ice and flame, then Pt₁₀₀ digital thermometer. Time taken so far: 45 Min.

Demonstration 9: Pressure – Atmospheric pressure by Hg Barometer, measure height, 71.5 cm at Khudapura. At sea level 76 cm of Hg.

Definition of pressure $P = h\rho g$ Pa (Pascal). $h = 0.76$ m, $\rho =$ density of Hg in SI unit = 13590.5 kg/m^3 ; $g = 9.81 \text{ m.s}^{-2}$; g value they have already measured with pendulum; h is measured just now. Substitute and get $P = 101325$ Pa. Make the teachers calculate P at one atmosphere in the class. They will see how 101325 Pa comes from mercury barometer. They knew this number but did not know how 101325 Pa for one atmosphere is arrived.

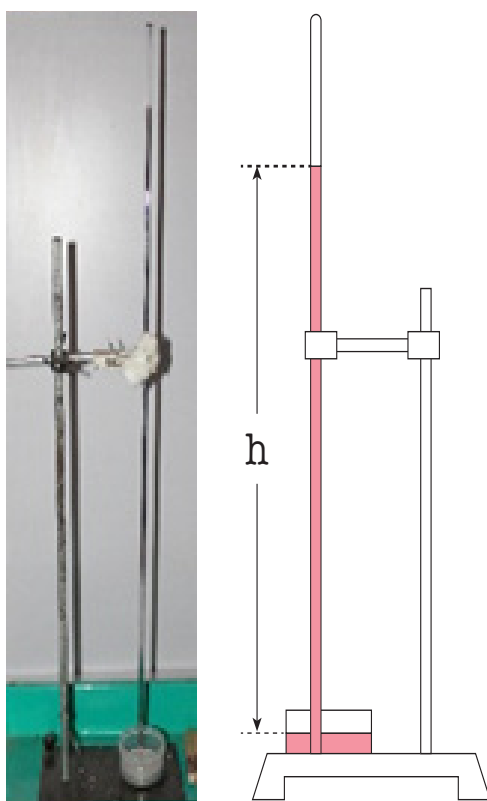

Application of atmospheric pressure:

Demonstration 10: Manometer, tube level – Manometer concept used to build houses; Water level in the manometer – both sides pressure is the same because both sides are open to atmosphere. Water level is the same at sea level across the globe; make them understand why sea level is at height zero as the standard.



Demonstration 11: Working of siphon. Fountains below a Dam. Water supply from water tanks and reservoirs; Water for agriculture- examples they know.



Demonstration 12: Show a strain gauge digital pressure meter in Pa replacing Hg barometer. Suck by mouth and pressurise by mouth, variation of pressure; digital pressure meter without Mercury; 95.1 kpa at Khudapura.



Time 1h 30 Min. Breakfast at 9:30 AM.
10:15 AM second class reassembles:

CONCEPT – VOLUME.

Demonstration 13: Measuring equipment of volume, SI unit m^3 ; = 1000 lit. 1 lit. = 1000 ml or CC or cm^3 . Show one lit., 500 ml, 200 ml, 100 ml, 450 ml. 25 ml measuring cans, make a teacher measure volume of a small bucket; smaller volumes by burette, pipette, micropipette, least count of a burette, pipette. Beakers of different volumes, test tubes and so on.



Gas laws

Define the laws and send them to perform experiments in the laboratory. Instructors take over.

BOYLE’S LAW:

Experiment 1: Pressure is inversely proportional to volume at constant temperature. Make the teachers do an experiment to prove $PV = P_1V_1 = P_2V_2$ in 45 min.

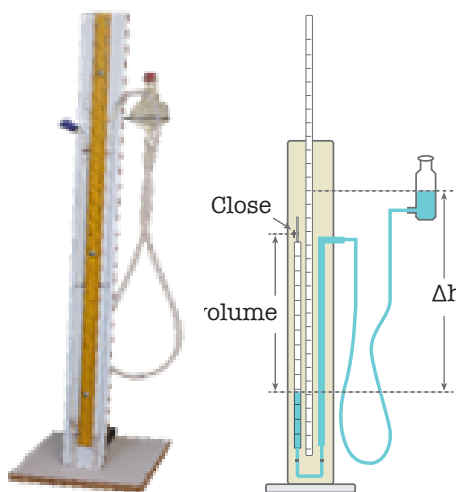

CHARLES’ LAW:

Experiment 2: Pressure is directly proportional to temperature at constant volume.

45 min experiment – make the teachers do it. Make them plot P vs T – a straight line.

Extending the straight line to touch 0 pressure give absolute Zero at $-273^{\circ}C$

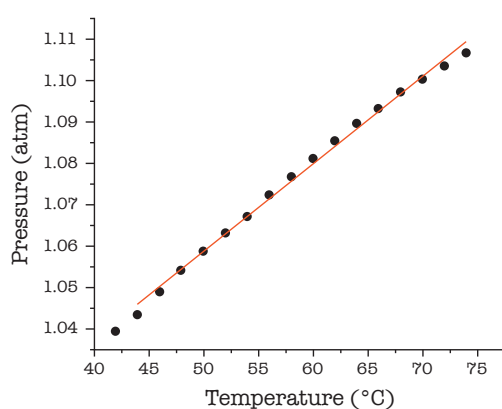

Instructors teach how to do experiments. Teachers do experiments and show the results, checked by the instructors.

Lunch: 1-30 pm.

2-15 Class resumes.



ABSOLUTE ZERO:

Experiment 4: Concept of Absolute zero; Measurement of absolute zero.
 – Measure temperature and pressure of air locked in a stainless vessel, plot P vs temperature in °C, extrapolate the straight line to cut x-axis – meaning temperature at zero pressure. This experiment takes about 1 hour. They are able to see how absolute zero = -273°C obtained experimentally. Then $0^{\circ}\text{C} = +273\text{ K}$, $27^{\circ}\text{C} = 27 + 273 = 300\text{ K}$. Why temperature cannot be negative? Such points are covered.

SPECIFIC HEAT:

Experiment 3: Heat required to raise the temperature of 1 g of material by 1°C . Transfer a piece of Al in hot water at 65°C , drop it in a 100 ml beaker with 15 ml water at a measured temperature, find rise in temperature, calculate sp. Heat of Al taken sp. Heat of water value 4.18 J/K . 45 min.



IDEAL GAS LAW:

$PV = nRT$, V is proportional to n , P and T are intrinsic properties, does not depend on amount of substances, idea of STP – standard pressure = 101325 Pa, $T = 273$ K; $R = 8.414$ J/(MK) (R can also be measured but by PU teachers).

Volume occupied by one mole ($n = 1$) of any gas = $8.314 \times 273 / 101325 \text{ m}^3 = 0.0224 \text{ m}^3 = 22.4 \text{ lit}$. Each one calculates the number in the class. How they get 22.4 lit for one mole of any gas at STP. Hitherto it was not clear to the teachers how 22.4 lit. value is obtained.

Demonstration 14: Pressure cooker – application of ideal gas law. At 100°C that is at high temperature, water is in gaseous state and so ideal gas law can be applied. Connect a pressure meter and make arrangement to measure temperature. Operate the pressure cooker; add 100 ml of water, heat on a stove; it starts whistling - now show pressure is rising and temperature also rises from 115 to 120°C , whistles, pressure and temperature drops. Pressure and temperature again rises and whistles again repeatedly. What is the pressure the cooker reaches before whistle?

$P_1 V_1 = nRT_1$ (Initial condition); $P_2 V_2 = nRT_2$; (final condition), $P_1 = 1 \text{ atm.}$; $V_1 = V_2 = 3 \text{ lit}$. $T_1 = 27 + 273 = 300 \text{ K}$. $T_2 = 273 + 120 = 395 \text{ K}$. Make the teachers substitute the vales in the equation; $P_2 = T_2 / T_1 = 393 / 300 = 1.31$. Increase in pressure is by 0.31 atm. for a rise of temperature 300 to 393 K.

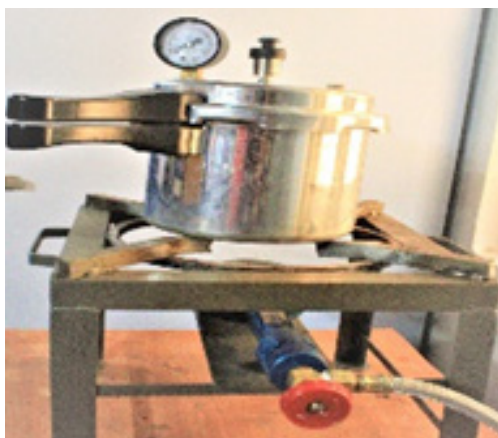

Experiment 5: Linear thermal expansion; Equipment designed at TDC, pass current in a 1 m meter bridge wire, put a Thermocouple to measure rise in temperature; Put a small wt. at the centre of the wire. Due to expansion, it now forms double Rectangular triangle. Find the expansion by Pythagoras theorem. 1 mm in 1000 mm can be easily measured. Substitute $\Delta L / L \times 1 / \Delta T$ gives the thermal expansion coefficient.



Experiment 6: Volume expansion; Take a burette and dip in cold and hot water. Measure temperature. You will find there is volume expansion; $\Delta V / V \times 1 / \Delta T$ gives the value expansion for water.

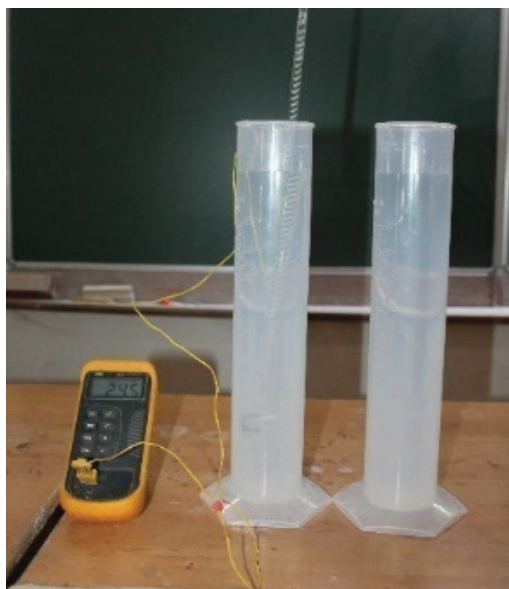

Experiment 7: Heat transfer by conduction; Heating Cu, Al, Fe, SS and glass metal rods two at a time, find which heats up faster from the feel of the fingers. Grade them in increasing order.

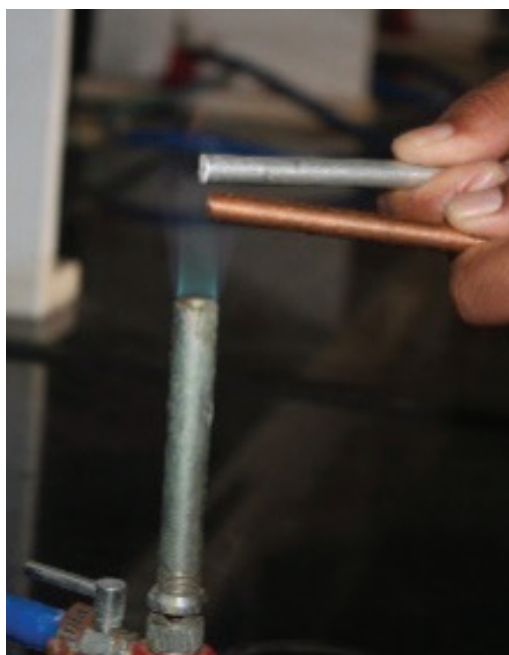

Demonstration 15: Heat transfer by convection. Heating water in a beaker at the corner with KMnO_4 . Show the convection.

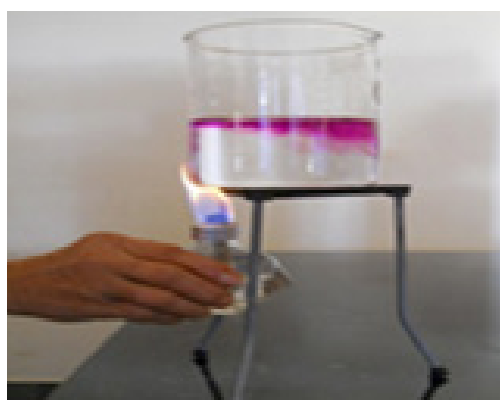

Demonstration 16: Heat transfer by radiation: two identical lamps one with kerosene and one with alcohol. Alcohol lamp with blue light is too hot compared to kerosene lamp of yellow colour.

$E = hv = hc/\lambda$; bring back the relation of energy and light which they have done in light chapter. Idea of light and heat; light is also heat, when absorbed;



Remind them to feel heat by standing by the side of a wall heated by Sun in the evening in summer and feel heat radiation, that is electromagnetic radiation. So, heat is also light but cannot see from our eyes.

Since there are only 10 days for the entire science – 8th, 9th and 10th class topics should be covered, thus teachers need to work hard. On part of the TDC, the program needs to be smoothly carried out. Conclude the lecture with hand out of an assignment of about 15 small questions, mostly repeat of what they have learnt in the class. They have to submit next morning the answers. That will be discussed in the class.

By 5-30 to 6 pm day ends with tea and snack.

Note: Learn science by doing experiments, by observing demonstrations, by calculating numbers from the formula, units for measured values, writing correct answers to question in assignments are practiced by the teachers in TDC. Since the teachers know the subjects to some extent, it is possible to implement a rigorous training program. The fact is the teachers are interested in learning because they need to know them correctly. Since there is lots of physical activity teachers are kept alert and fully occupied. They are excited to do the experiments because experiments are interesting and they have not done most of them. Because experiments give numbers and they are familiar. Learning is joy. Learning science they need is even greater joy for teachers.

In one day a lot can be accomplished.

The same set of 7 to 8 experiments and 16 demonstrations spread over weeks and months in the classes in their schools provide new way of learning. For this they need to be equipped.

High School Mathematics – Method of Training

In high school teachers' training program, mathematics is taught through problem solving. As they are teachers and having 10–15 years of teaching experience, we may assume that they know the basic theorems, formulae and simple concepts. But we find many of the teachers are poor both in the basic concepts and in applying these concepts/theorems in solving simple problems. Some are even poor in solving direct formula substitution problems. So, we need to make them understand concepts and then induce them to think of applying those concepts in solving problems. We have observed that the teachers who come for training are of three categories:

- a. Good: Teachers who are enthusiastic and want to learn (~ 20%).
- b. Average: Teachers who are average learners and need to learn concepts (65%).
- c. Poor: Teachers who are having low competence (~ 15%).

In first two days of training, we locate the weaker ones by conducting various kinds of tests. Question papers are set in such a way that questions are within the high school teacher's competence level and within their syllabus.

First Test

First test on the first hour of first day is to assess the knowledge of teachers in mathematics. Questions are such as to find the level of understanding of concepts. Test will give us a feedback of how good are they. Question paper is divided into three parts.

Direct questions from the high school books/ formula substitution:

Examples

- A drinking glass is in the shape of a frustum of a cone of height 14 cm. The diameters of its two circular ends are 8 cm and 6 cm. Find the capacity of the glass.
- If $(1, 2)$, $(4, y)$, $(x, 6)$ and $(3, 5)$ are the vertices of a parallelogram taken in order, find x and y .
- A train travels 360 km at a uniform speed. If the speed had been 5 km/h more, it would have taken 1 hour less for the same journey. Find the speed of the train.

Concept based questions to check the teachers understanding of concepts.

- For what values of c , the pair of equations $x - 2y = 8$ and $5x - 10y = c$ have unique solution.
- Prove that $5^4 + 2^{10}$ is a composite number
- Determine the number of all positive integers less than 5670 if each is divisible by 5, 7, 9

Questions on thinking ability

- A two-digit number is such that when a decimal point is placed between its digits the resulting number is $\frac{1}{4}$ times the sum of its digits. Find the number.
- If in an AP, m times the m -th term is equal to n times the n -th term, then find $(m + n)$ th term.
- When the integer n is divided by 8, the remainder is 3. What is the remainder if $6n$ is divided by 8?

Needless to say that average marks scored in the first test has not crossed 25% over last 11 years in TDC over 4000 teachers. We feel teachers should be capable of solving problems within their high school subject. But our experience is that most of the teachers are not even able to solve problems in their text books.

The mathematics course consists of 7 modules covering full subjects in 8, 9 and 10 classes:

1. Geometry;
2. Counting and Probability;
3. Numbers and Progression;
4. Equations and Identities;
5. Statistics;
6. Trigonometry and
7. Coordinate Geometry.

Every concept is taught in the class along with solving problems. Three lectures of 1 hour, each followed by one and half hour problems solving sessions. Assignment consisting of 30 - 35 problems is given to the teachers to work in class. Teachers solve these problems with the help of professor, instructors, discussing among themselves and referring books. After each session, teachers have to show the fair copy of the solved problems to the instructors. Instructors will check their answers, correct them if there are any mistakes and give them back.

Design of Assignments

The questions are designed in such way that first few problems will be simple and most of the teachers should be able to answer. This is to give them confidence that they are capable. Next few will be concept based and others will be somewhat hard problems. Examples:

- Prove that $n^2 - n$ is divisible by 2.
- If m and n are odd integers, prove that $m^2 + n^2$ is even number, but not divisible by 4.

- If n is an odd integer, prove that $n^2 - 1$ divisible by 8.

First two problems are simple and needs some assistance. Also, the concepts involving to solve these problems were taught in theory class. Once the teachers solve first two problems most of them will be able to solve third problem.

Prove that $n^2 - n$ is divisible by 2.

Solution: $n^2 - n = n(n - 1)$.

n and $(n - 1)$ are two consecutive numbers. Therefore, one of them must be even. Product of even and odd number gives even number and every even number is divisible by 2. Hence $n^2 - n$ is divisible by 2.

$\therefore n^2 - n = 2M$
where $M \in \mathbb{Z}$

Note: If a number k is divided with another number, the number can be written in the form $k \times M$. Where $M \in \mathbb{Z}$.

If m and n are odd positive integers, prove that $m^2 + n^2$ is divisible by 2, but not divisible by 4.

Solution:

Let $m = 2k_1 + 1$ and
 $n = 2k_2 + 1$, where $k_1, k_2 \in \mathbb{N}$.

$$m^2 + n^2 = (2k_1 + 1)^2 + (2k_2 + 1)^2$$

$$\begin{aligned}
&= 4(k_1)^2 + 4k_1 + 1 + 4(k_2)^2 + 4k_2 + 1 \\
&= 4(k_1)^2 + 4k_1 + 4(k_2)^2 + 4k_2 + 2 \\
&= 4(k_1^2 + k_1 + k_2^2 + k_2) + 2 \\
&= 4(q) + 2 \quad \text{where } q = k_1^2 + k_1 + k_2^2 + k_2 \\
&= 2(2q) + 2 \\
&= 2(2q + 1) \\
&= 2(M) \text{ where } M = 2q + 1
\end{aligned}$$

$2M$ is divisible by 2. Therefore, $m^2 + n^2$ is divisible by 2.

Now,

$$m^2 + n^2 = 4q + 2$$

$4q$ is divisible by 4 but 2 is not divisible by 4. Hence $m^2 + n^2$ is not divisible by 4.

After solving these two problems they will know when one can say a number is divisible by a particular number and general representation of even and odd numbers. Now they solve the third problem without anyone's help.

If n is an odd integer, prove that $n^2 - 1$ divisible by 8.

Solution: Let $n = 2k + 1$ where $k \in \mathbb{Z}$

$$\begin{aligned}
n^2 - 1 &= (2k + 1)^2 - 1 \\
&= 4k^2 + 4k + 1 - 1 \\
&= 4(k^2 + k) \\
&= 4k(k + 1)
\end{aligned}$$

Here $k(k + 1)$ is product of two consecutive numbers. Therefore, it is divisible by 2

So, we can write $k(k + 1) = 2M$
where $M \in \mathbb{Z}$

$$n^2 - 1 = 4 \times 2M = 8M$$

Therefore, $n^2 - 1$ is divisible by 8 if n is an odd integer

Teachers find this problem easier to solve, because they have already solved similar kind of problems. Also, they will understand these concepts much more easily than formal teaching.

Every day, they would finish one module. They will be given homework of quick answer problems to submit next day morning.

(Text) Book test

The second day morning at 8 am, 45 min. test is given where the problems are solved problems or from the exercises at the end of a chapter in 8, 9 and 10 books. This will tell us who among them teaches complete book. This also makes the teachers to realise they lack knowledge and they have not taught the book itself fully. Average marks scored is less than 35% over 4000 teachers. This means most teachers have not taught the text books well. Now one can imagine the fate of students. This point is made to the teachers; they become serious to learn and prove themselves before leaving TDC. Care needs to be exercised in

conveying these messages politely so as not to hurt their feeling. In fact, one should not tell anything after the answer papers are given back. The tests therefore serve huge purpose of introspection and self-realization. The day continues with the lectures/ assignment writing.

Class Tests

The third day on words, every morning a quick half an hour test is conducted to assess how much of the teaching/ problem solving they are able to assimilate. For each module/topic we conduct one class test. Test questions will be similar to what they have solved in the previous day.

Typical examples:

Assignment: If $\sin(3x - 20) = \cos(x - 10)$, find x

Class Test: If $\sin(2x - 20) = \cos(x - 25)$, find x

Assignment: Find the sum of all the angles at the five vertices of the adjoining star.

Class Test: Prove that the sum of all six corner angles in the adjacent figure is 360° .

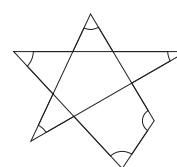

This test gives us a feedback of how much they can assimilate, understand and remember. Also, these tests help us to identify the slow learners and we identify them to give more personal attention and they are tutored one-to-one.

Everyday evening generally before they leave, morning test paper is discussed, solved on the board. Day by day, the teachers improve their performances in the morning test. One day is exclusively kept for revision.

Revision

Teachers were given 3–4 hours time to revise the topics. They go over assignments and tests which they have written. Solutions of test questions were discussed with them or solved on the board for their benefit. In addition, a new set of 30 problems similar to previous ones were given to them. A test is now given, call it revision test. This is the second level test.

Revision test is to see how much they can reproduce and also to know how they are progressing. Total of 3 revision test are conducted. Each test is based on questions from two to three modules or assignment topics. As far as possible, problems are modified with numbers only are given so that they get used to solve similar problems. Generally, revision is on 9th day of the

program when formal teaching and syllabus teaching is completed.

On the revision day, the slow learners are trained more on the text book problems. One or two hours of separate sessions are held for them in a separate class room. By this time, they agree to come and study leaving the rest from the class.

Final Test

Final test is to see how much teachers have learnt from our training. One may get an impression that there are too many tests. This is not true. It is 30 min each day morning out of 8 to 9 contact hours. We have now found that repeatedly solving similar problems is the only method to make the teachers learn. There are parallel examples for this in mathematics. Tables learnt in the class 1 at the age of 6 ($1 \times 1 = 1$ to $10 \times 1 = 10$) and class 2 at the age of 7 (11×1 to $20 \times 10 = 200$) are correctly and fully remembered by everyone in India. An illiterate also knows by heart the tables. This is because we have chanted the tables about 300 times. Application of tables is the only thing we use every day. Applying this idea to make the teachers learn mathematics by revision and repeated writing in the tests and assignments indeed works for them to remember well. The very fact that they attempt and become successful to solve new problems

within the subject proves the point that the method is far more successful than mere repeating and revision. They start learning how to think and solve the problem by applying concepts. Not only have the teachers learnt, they realise that they can learn by this repetition - method. This also becomes a method for them to apply on students. Not that we have discovered this newly. This method was there all the time. It is just that by making the teachers work more and requirement of making them to succeed, has made TDC distinct than many training programs they undergo. Grading each test immediately, change the problem sets and making new problem sets needs a lot of effort and dedication on the part of instructors and tutors.

Each and every teacher is important in our scheme of training program. If in a school, a mathematics teacher is not doing well, that school is behind till the teacher continues in the school. About 10% of teachers are in this category. How can TDC make even these teachers become sufficiently good? It is not correct for TDC to tell the govt. that they are not good. Teachers have been appointed on the basis of merit. If the Govt. says, we know some are not good in spite of due process of selection. We can provide money for any kind of special training. Can you train them so that they too become good teachers? Does TDC, IISc has methods to make slow learners to become good teachers? How to make

weaker teachers reasonably good so that future of students is not seriously affected? This is also addressed in TDC.

By nature, mathematics is an abstract subject, perceived as difficult. Newer methods need to be discovered to make them learn. After four to five days in TDC, we identify those 10% teachers and give them special coaching as to how to learn mathematics.

Theorems- write five to 10 times. Proving the theorems – writing correctly 5 times. Simple problems – similar problems – teach them solve; slowly reduce the teaching and make them do the work. Make the teachers solve problems from books only. Engage them till they become successful. It must be mentioned here that teachers once they realise they need help, they do work hard and put efforts to learn. Persuasion, building their confidence, win the hearts and any such method that will help them has to be tried. More time is given to the individual teachers. However, these slow learning teachers also have to pass the same final test. Only those who scored 40% and above are given certificates and this has some effect on the teachers to work hard and get the certificates.

Even with all these efforts, one or two in 100 may not perform well. This could be due to various limitations. Interestingly, the school/headmaster knows about these teachers. There are

fairly large number of instances that such teachers part half of their salaries to a contract teacher who teaches the classes. Among the teachers about 5% to 7% score 100% marks.

Not giving part marks during the training has a huge effect on the scores. Practice of giving part marks in a question in the schools have made the teachers not competitive. That is in the scoring patterns of students. This particular aspect of training has given maximum dividends.

Story of a teacher who was physically handicapped teaching class 8 may be instructive. The school had two divisions and he was teaching mathematics for both the 8th class students. He was not able to solve any problem of any chapter of class 8 book. Two of his sons were BE students. They had come to take care of him to TDC. On the first two days we had found the problem. He was thinking that we will leave him to go back. Then a tutor was assigned and taught him mathematics. He learnt fully the 8th book and could solve the book problems fully. He was really happy that he learnt and we believe we have saved the school.

Experience from Performance of Teachers

On the first day, after preliminary introduction of the purpose of training, a test for 1 hour is given to all the

teachers. The test is on what they are supposed to know. It is at SSLC level. The questions are designed such that they need to provide exact answer. Teachers need to teach all the subjects and so there are no choices. Questions with multiple choice answers is totally avoided. Even tricky questions are avoided to get a factual assessment of their knowledge. At the end of the training another test of the same degree of difficulty gives us the impact of the training. Care is taken to keep the degree of difficulty of the two papers is same. Questions are completely different. Many a times, not exactly the same pattern. They are tested in about 7% of the knowledge within 8, 9 ad 10 class subjects taught to them.

All the corrected test papers/results are given back to the teachers. All the teachers trained in TDC are knowing their own performance vis-vis others.

Average marks scored before and after the training in 2015, 2016, 2017, 2018 and 2019 are given in tables 1 and 2. Average marks scored before the training of mathematics teachers from among 2882 teachers is 15.2%. After the training, it has increased to 72%. This is a huge increase. The marks scored in the first test decreased and that in the final test increased from 2015 to 2019. Initial years, teachers interested in learning came for training. In the later years teachers reluctant to come have been persuaded to come. Year by year, training method was

enormously improved to take care of weaker teachers. It is extremely difficult to raise the average marks in mathematics. It is not sufficient if we bring out good results in one batch. In each of 10 to 13 batches of about 50 to 60 teachers per year, performance should be good. In each batch, each teacher should perform well. Then only the final average increases.

Similar trend can be seen in the performance of science teachers. In general, making science teacher learn and perform better is easier than mathematics teachers. Science teachers are able to pick up more easily because of experiment. Teachers feel the final test is easier. This is because they have gained knowledge during the training.

Table 1: Mathematics PCM teachers trained in the years 2015 - 2019

Year	Number of Teachers	Marks Average in % pretest	Marks Average in % posttest
2015	674	30	74
2016	598	18	72
2017	670	12	67
2018	469	7.2	70
2019	471	9	79
Total	2882	15.24	72.4

Table 2: Science CBZ teachers trained in the years 2015 - 2019

Year	Number of Participants	Marks Average in % pretest	Marks Average in % posttest
2015	639	28	80
2016	524	20	77
2017	583	17	78
2018	485	16.7	88
2019	472	14	86
Total	2703	19.14	81.8

Typical performances of individual teachers are given for mathematics and science teachers in the bar diagrams. In 1 to 10 bar diagrams, results of five mathematics and five science batch teachers' scores are plotted from five batches for five consecutive years 2015 to 2019. Y-axis shows the % of marks and x-axis shows the teacher number. Against each teacher number, there are two vertical bars, shorter one left side of teacher number is before the training and longer one is after the training. If there is only one before, he could not appear for the last for he had to leave with permission. Only the final one means, he came and joined late. No initial marks also mean he got

zero. Initial marks may look hugely disappointing but it is a fact. Low marks in the first test tells the teachers have poor knowledge within the text book. As one can see from the figures, hardly few pass on the 35 to 40% scale. No one has complained that the question paper is out of the subject they need to teach in high schools. Huge improvement in their performance is obvious in the post training test. After the training, huge increase in marks tells the quality of training. Also, it tells the teachers are talented and they can gain by working. Almost no body fails on 40% scale after the training.

Bar Diagram 1

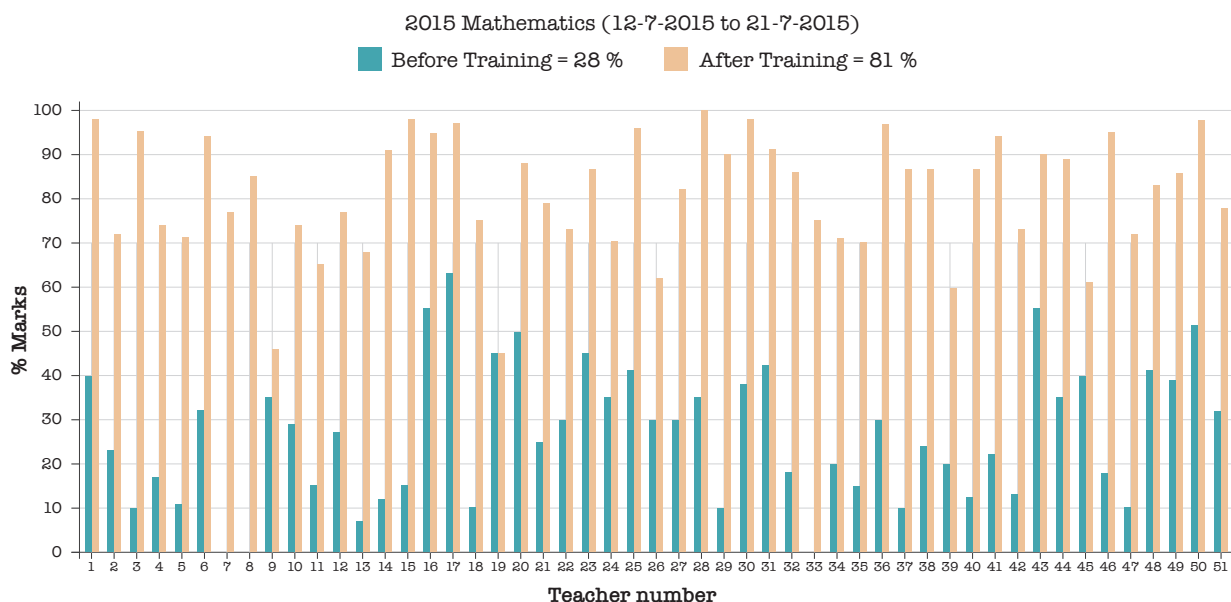

Bar Diagram 2

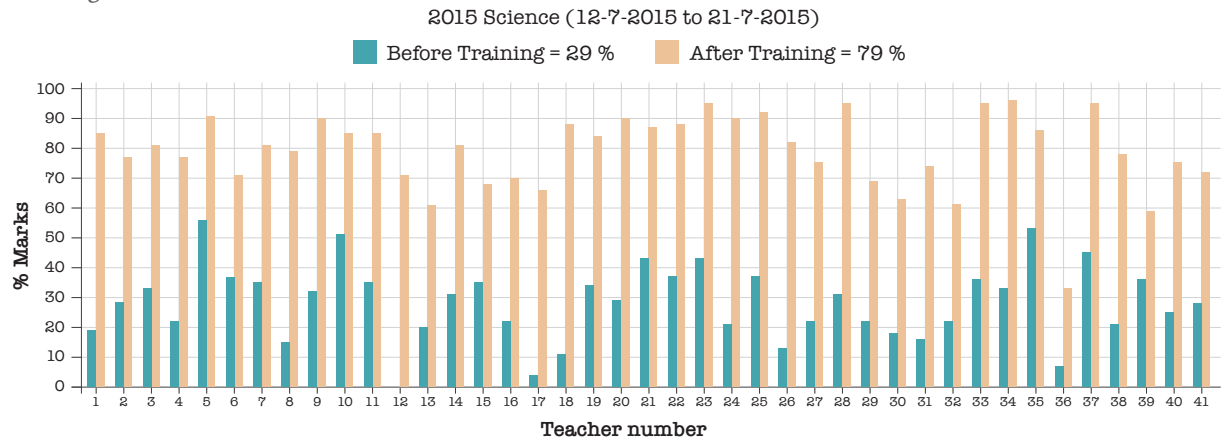

Bar Diagram 3

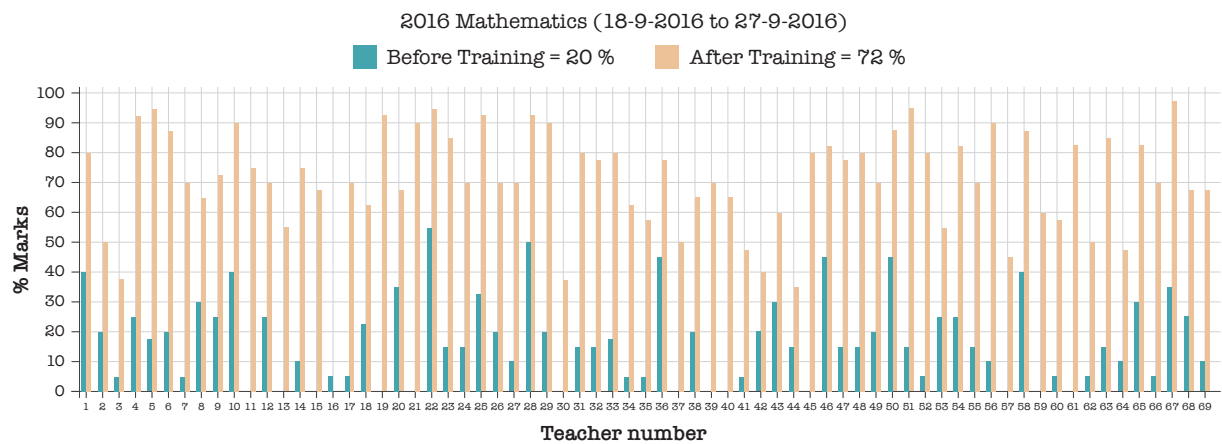

Bar Diagram 4

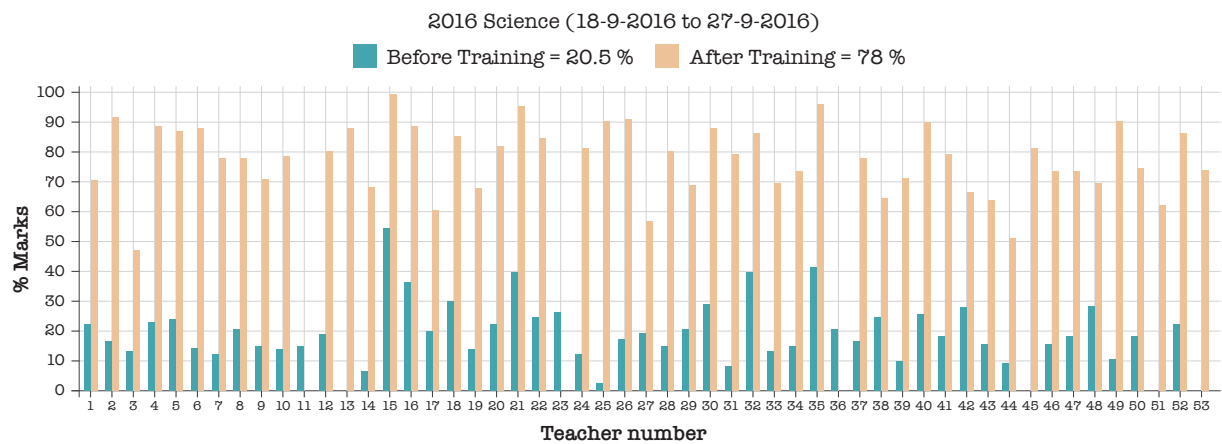

Bar Diagram 5

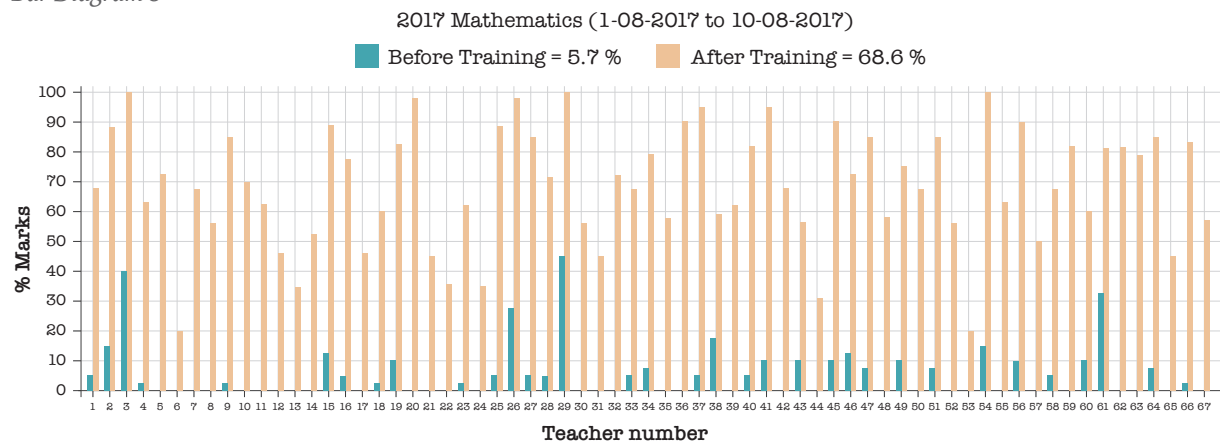

Bar Diagram 6

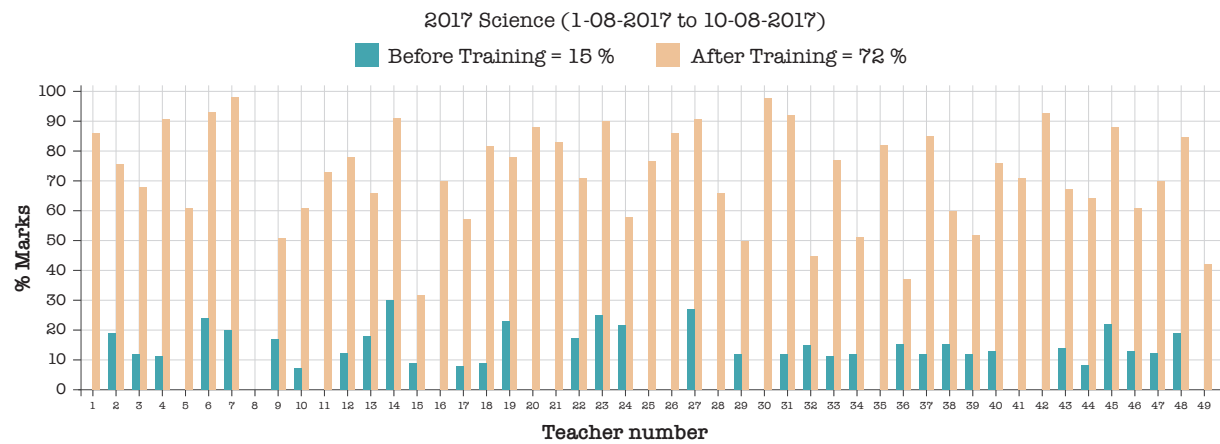

Bar Diagram 7

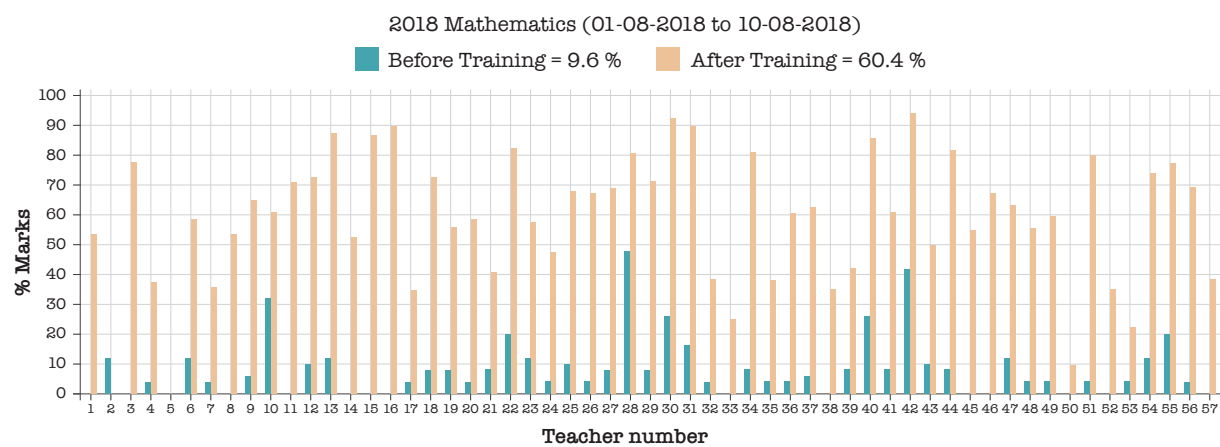

Bar Diagram 8

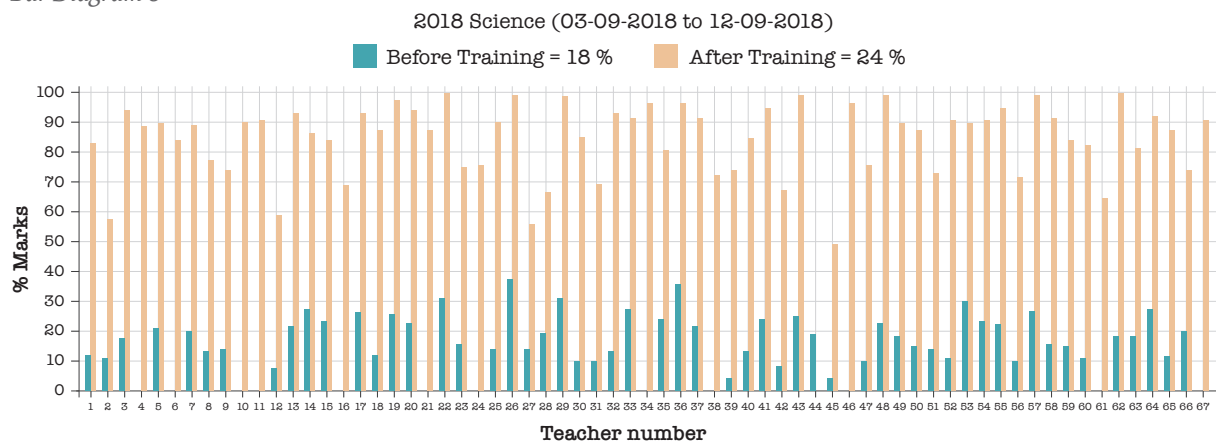

Bar Diagram 9

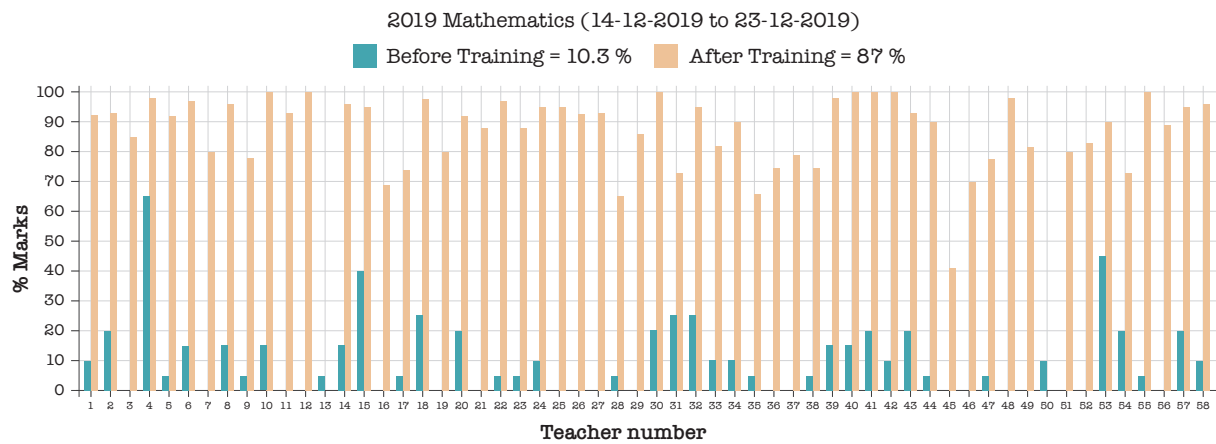

Bar Diagram 10

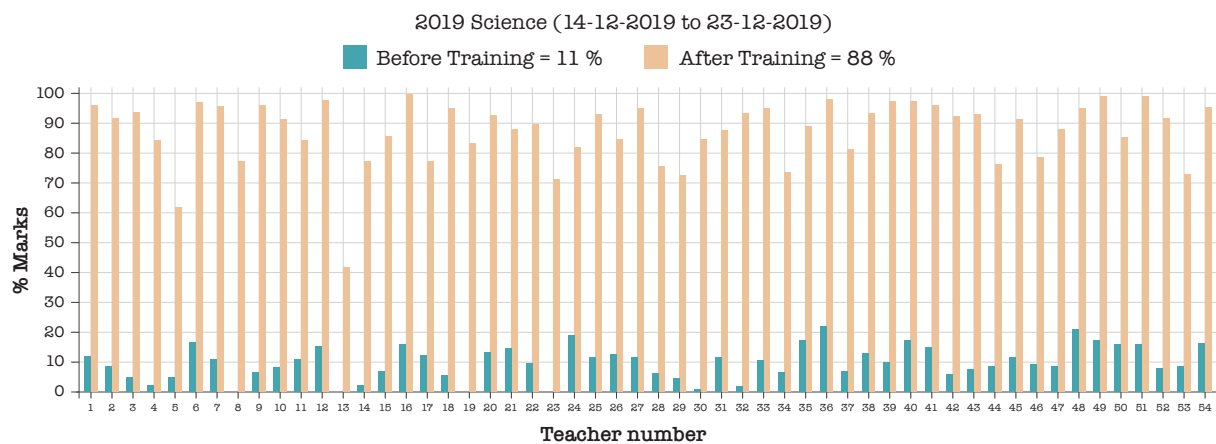

The bar diagrams are typical experiences of one of the 13 batches each year.

Reasons for poor performance given by the teachers are listed below.

- a. Teachers claim that they have not been taught properly in their SSLC, PUC and BSc.
- b. They have not studied high school books again after they left high school.
- c. BEd degree does not provide content enrichment. Method will not help if they do not know content.
- d. They have not performed experiments relevant to high school activities any time.
- e. Not lived in a residential atmosphere and difficult to overcome inferiority complexes.
- f. Hesitant to tell others that he/she does not understand lest others look down upon.
- g. Clue/method as to how to study itself is lacking. Not used to revise subject knowledge.
- h. Not aware that PU books contain the subject of high school.
- i. Demand by the system to make the students make just pass lowers their knowledge.
- j. Accept that habit of reading before going to cases is rare.
- k. Commitment to profession is low. Take it for granted that they are doing well.
- l. Assumption: "BSc degree holders

are knowledgeable for high school teaching" is not valid.

But there are many positive points about the teachers which are to be recognised by the trainers.

Not a single teacher refused to take a test or any number of tests during the training. They are somewhat innocent and definitely humble and keen to learn. They do feel the necessity to learn. They express clearly that the kind of in-service training they were subjected to in the past were not helpful to enrich the content. Time is spent on the method of teaching. Without knowing the subject, method of teaching will not help. 'How to learn' itself is somewhat new to many. How to apply their mind itself needs to be taught. Certainly, they have potential but they are not able to show their potential because they are unable to acquire that part of knowledge needed to teach high school students. The first test also gives them a jolt in their mind and sometimes they are even shocked to find themselves. Older teachers occasionally express that they are used to teach in Kannada language. Tests given in Kannada did not improve their performance. Soon they discover language is not an issue.

In addition to subject enrichment during the training program, teachers also pick up discipline, time consciousness, efficient use of time, writing skills, importance of revision,

discussion with fellow teachers to clarify doubts, identification of slow learners, treating students properly without shouting, right kind of inputs to students to learn and above all honesty.

Training to DIET College Teachers and Subject Inspectors

A training was conducted for over 110 Subject Inspectors (SIs) and DIET college lecturers in science and mathematics in TDC. This was at the request of the Director, DSERT. Diet College lectures are supposed to train high school and primary school teachers. They were given the same training as the high school teachers in science and mathematics. Their scores were far lower than the in-service teachers. This is not surprising because the SIs and DIET College teachers do not teach the students as they are

not at all familiar with the text books. No wonder, the training by the DIET College teachers under DSERT is less interesting for the teachers. Therefore, the Govt. should ponder over how to make the SIs and DIET- College useful to the school system. Possibly the Govt. realised this and many of the teachers deputed as Block Resource persons (BRPs) have been sent back to teach in the school. Absence of marks or bars in the diagram below is due to their scores are zero in the first test. The post-test performance is far below the serving high school teachers that can be compared from the bar diagrams 1 to 10. Under this kind of experiences with DIET College teachers on their knowledge, what kind of training these colleges can impart to the teachers to raise the level of learning? Again, it comes to who should train the teachers. Again, why IISC and such institutes should take up training teachers.

Bar Diagram 11

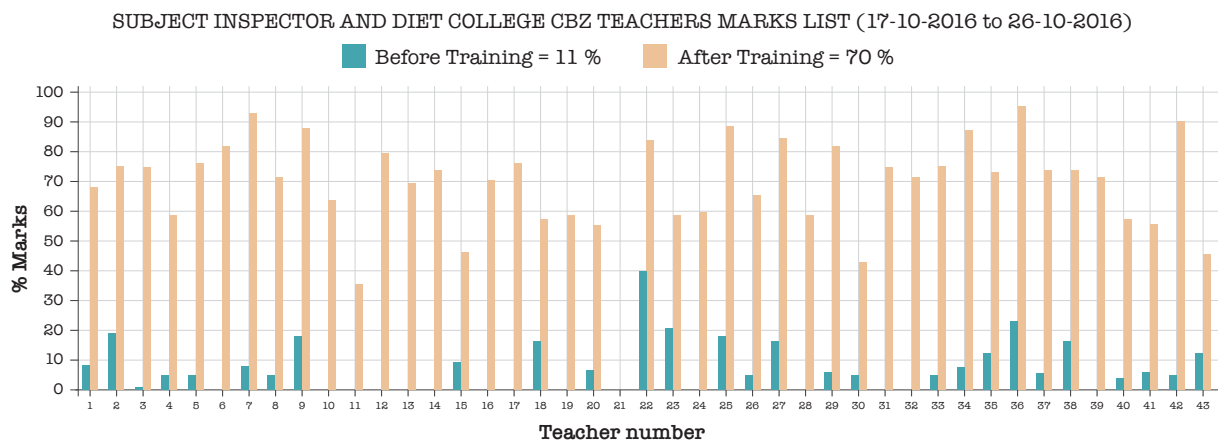

Bar Diagram 12

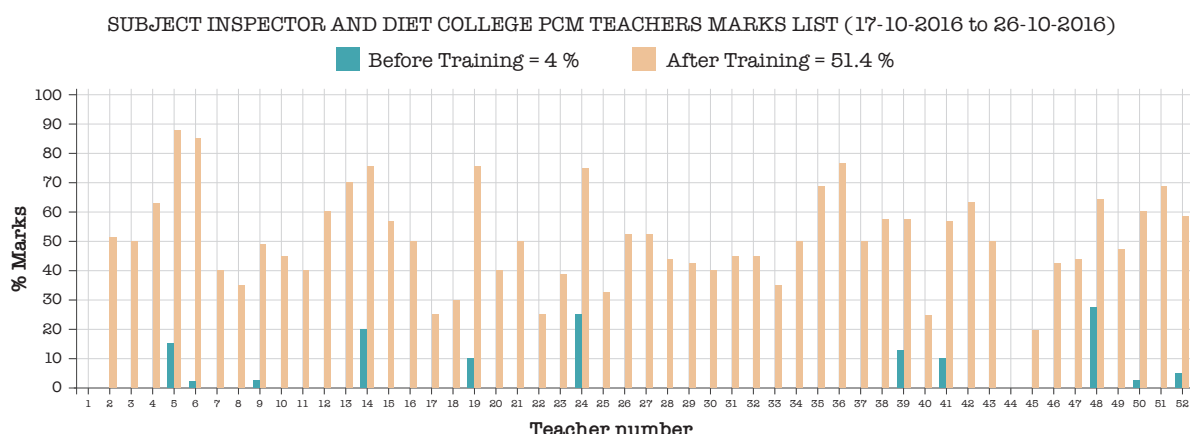

Since they are not teaching regular classes, they are extremely poor in high school knowledge. So, what is the meaning of Subject Inspectors in the high school system poses a serious question. Conclusion is obvious: Diet College teachers cannot train high school teachers and most subject inspectors cannot inspect teacher's teaching level to the students.

Teachers can Learn and Score Above 80% Marks in 10 Days

How can you make the teachers score more than 80% in 10 days? This question is often asked by the Education Secretaries, Directors of Public Instructions (DPIs), Deputy Director of public Instruction (DDPIs), Directors and Commissioners in the department and SAA. It looks a mystery for them. But it is not a mystery.

Highly focused teaching and training, training to write assignments, making them solve problems within the book (which most have not solved before), make them do experiments and understand the principles, discussion with professors at TDC freely and also with fellow teachers, residential atmosphere, at least 10 to 12 hours of work each day, splendid isolation of the TDC in Challakere for they cannot go anywhere and the competence of the trainers all put together make the teachers learn in a shorter period of time. A unique atmosphere of learning is created in TDC. It must be emphasised that the teachers want to learn and they feel the necessity to have full knowledge. That is the main reason for their success. Pre training test and post-training test method is certainly the prime factor for them to show their worth. It also reflects on the faculty members of IISc in the TDC. They need to come down to the level of high school and teach what

the teachers want to learn within their needs – essentially within the books. Training is designed to make poorly performing teachers in their subject gather enough knowledge to make the students score 60% marks. Those who are already good are made more capable to enhance their students' competence to score 100% marks.

The method followed is course system in IITs. The entire 8th, 9th and 10th class subjects are broken into topics. Well thought out concise lectures are given to cover all the topics. Assignments are carefully designed to cover all aspects of the syllabus. Deliberately, the subject level is kept slightly higher than they would need, yet within the book broad contours of syllabus. This is not told to them. This also makes the teachers learn new subjects and it becomes interesting. Learning new subjects makes the teachers happy. Learning a subject correctly also makes them happy. It is important for the trainers to make the teachers interested to learn. Here the experience of TDC faculty counts a lot.

Science teachers perform better than mathematics teachers mainly because they do experiments. Learning science by doing experiments where they spend more time to understand the concepts indeed helps the teachers to learn science. Seeing is believing. Performing an experiment is an experience. All the CBZ science teachers spend five days on physics

and now the CBZ teachers teach full science book in their school. Mathematics teacher can fully devote his time for mathematics. This is the contribution of IISc TDC to Karnataka school system.

Demand for proper learning in the schools has been steadily increasing. Weaning away students to private schools (= English Medium) is threatening the security of their jobs. Now and then, newspaper reports stating the 'Govt. Schools are poor' haunts them. Therefore, when the opportunity is available to learn, teachers are putting hard work to learn. This is also a factor for them to do well during the training at TDC.

Another factor that is noticed by the teachers is the depth of knowledge and honesty of IISc faculty in TDC. Teachers do not like to learn from the instructors/BRPs, RPs of the same cadre as it happens in the training arranged by the DSERT. Wasting time in the in-service Dept. Training Programs has a huge negative effect. Official functionalities, garlanding officials, waiting for the dignitaries, delay in the programs and underutilisation of time for actual teaching, quality of food, no place to stay in the night, and many such experiences has made the teachers not to come for training. It is extremely difficult to convince the teachers that in TDC, they can learn what they need. This is one reason for lower level of attendance for training in TDC. On the

contrary, time management during the 10 days is another factor. The progress is essentially monitored on hourly basis and time is not wasted in TDC which is appreciated by the teachers.

Openness of the program is yet another factor. All the faculty members sit in the halls after the lecture and are accessible. They are extremely punctual. Teachers do not have time to read the books during the ten days. They need to refer to their notes, handouts and corrected assignments. Repeating the same idea at least three times make them grasp and keep them in memory. Writing the answers correctly is given a lot of emphasis. The questions designed are such that they need exact answers. No part mark for a question in the tests – teachers should not make mistakes and they should score full marks. They are taught that ultimately, the students they teach should pass a written examination and score high marks. This point indeed goes to their head.

Indeed, it has been a great learning experience to be with high school science and mathematics teachers. It is a pleasure to see they learn and express that they will teach the students what they have learnt in TDC before they leave on the 10th day. The teachers are free to express their feeling during the feedback session. The teachers want experiment kits for their schools. They promise that they will adopt all the good method they have learnt in

the training. They do suggest how to improve the training even further. TDC takes their valuable suggestions and implement them in the subsequent programs. A large number of trained teachers are in touch with the TDC faculty and tutors. That makes the TDC staff and assistants happy to welcome the next batch of teachers next or next to next day.

Impact of TDC-trained Teachers on Students' Performance

Karnataka has about 10,600 PCM mathematics teachers and 7,800 CBZ Science teachers in 8,446 government and government-aided schools. Till now, 4,257 mathematics (40.3%) and 4,061 (52.1%) science teachers have received training at TDC.

Why Mathematics and Science Teachers' Training is More Important?

We analysed the SSLC examination results of all the students appeared in 2019 in all the subjects in different districts of Karnataka. We found lowest percentage of passing is in mathematics paper followed by science paper. Percentage of passing in mathematics correlates linearly with overall passing percentage of students in the districts

given in Figure 5.1. Overall passing percentage decreases from 89% to 55% and that in mathematics from 92% to 61%. Therefore, mathematics is the key subject that decides the future of students. Next subject that decides the fate of the students is Science.

Figure 5.1

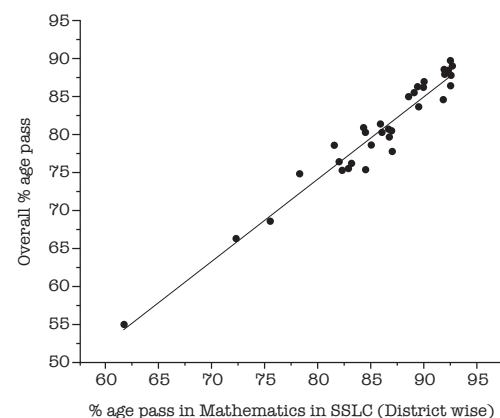

Therefore, emphasis to train mathematics and science teachers is indeed the right decision and rightly supported by the Govt.

How the Trained Teachers Transfer Their Knowledge to the Students?

With intense discussions with the teachers and the faculty of TDC over 9 years, the following ideas have emerged.

- a. It is essential to start teaching and training the students from 8th class itself.
- b. Generally, teachers spend more time mainly in 10th class neglecting class 8 and 9.
- c. Attitude of the entire State Govt. Education Department and the teachers is: give importance to passing percentage- make the students pass – just pass.
- d. Attitude of teachers when they come for the training is – make the students just pass.
- e. This brought down the level of teachers' knowledge to teach the subjects correctly and properly covering full books. Teachers did not excite intelligent students – so they move to private schools.
- f. It was not realised by the teachers that if the attitude was to make every student score more than 60%, passing percentage also increases.
- g. Teach, train and prepare the students starting at class 8, followed by 9 and finally 10. By the time the students come to class 10, students are able to learn more easily – a point that is accepted.
- h. Therefore, a trained teacher in science and mathematics need three years to bring out the full effect of training in terms of higher scores in SSLC examination.
- i. Primary reason for the low score or low passing percentage of students is the lower level of knowledge the teachers possess. Regular SSLC paper without choices and marks for only accurate answers when given to the teachers, most of them scored less than 25%. Then how will they make the students pass let alone making them score more than 60%? This point was acknowledged by the teachers who came for training.
- j. Their complaint is that they have not received proper education in their PU and BSc classes. Therefore, the training was to increase the knowledge of the teacher so that the teacher scores more than 80% in a difficult SSLC/CBSE examination.
- k. Testing procedure in the schools has deteriorated. Practice of giving part marks during the class tests kills the idea of getting full marks. No student will attempt to

- get 100% marks.
- l. Training the teachers by not giving part marks in TDC is appreciated. Not giving part marks during training is expected to have a huge impact if the teachers adopt it in class rooms and class tests.
 - m. Writing the correct answers to question during the training beginning 8th class and carry till the end of 10 is crucial to make the students learn.

While the teachers' performance in 10 days is impressive, how will they perform in their respective schools? How will they transfer their knowledge to the students? How will the students perform after three years a teacher has received training when he/she taught science or mathematics to the same class from 8 to 9 and 9 to 10? These are the questions often asked by educationalists and funding agencies. One direct method to find answer to these questions is to evaluate and analyse the marks scored by the students in SSLC examination. We have found a novel method of performance analysis of trained teachers in schools. Karnataka Govt. was kind enough to provide the results of students who appeared for SSLC examination from 2015 to 2019. They have also provided school codes and school teachers list. We have used the data to analyse the performance of schools before and after training the teachers in the schools. Perhaps,

this is the first such exercise in India to evaluate the students' performance after the teachers are trained.

Method of Performance Analysis

We identify the trained and untrained teacher with the school code. Analyse separately performance of students in science paper with science trained teacher and mathematics paper with mathematics trained teacher. The training provided in TDC is to enhance overall knowledge of the students and not to make the students just pass. We expect that the training should help the teacher prepare the students score more marks in science and mathematics. Overall, 60% marks is a reasonable score a student should get with the efforts by the teacher if the teacher is to be taken as successful. It is considered difficult to score 60% by copying. Analysis of data will have some credibility. From Vijayapura, one of the districts of Karnataka, 24 trained schools were randomly taken to find a method of analysis. Accordingly, the percentage of students scoring more than 60% marks in mathematics in 24 schools were plotted for five consecutive years as shown in Figure 5.2.

Not all the schools/teachers trained at TDC can perform to the same extent as seen from their own performance during the training at TDC. Some of

them do well and some do not do well. Question now is how to find who and how many performed well among the trained teachers.

The graph in Figure 5.2 is scattered and difficult to find a pattern. However, on a closer look at the plots, a set of five bars indicating the percentage of students scoring more than 60 marks is high and increasing year by year. Take for example, a school with code

OO0001 and OO0003 in Figure 5.2. Five bars for the same school represent scores in five years from 2015 to 2019 in the same order is consistently low. Code OO0036; bar height increases year by year. There are set off five bars which are consistently high. One simple way to distinguish them is to separate the low score and high score schools. This is done in figure 5.3 out of Figure 5.2.

Figure 5.2

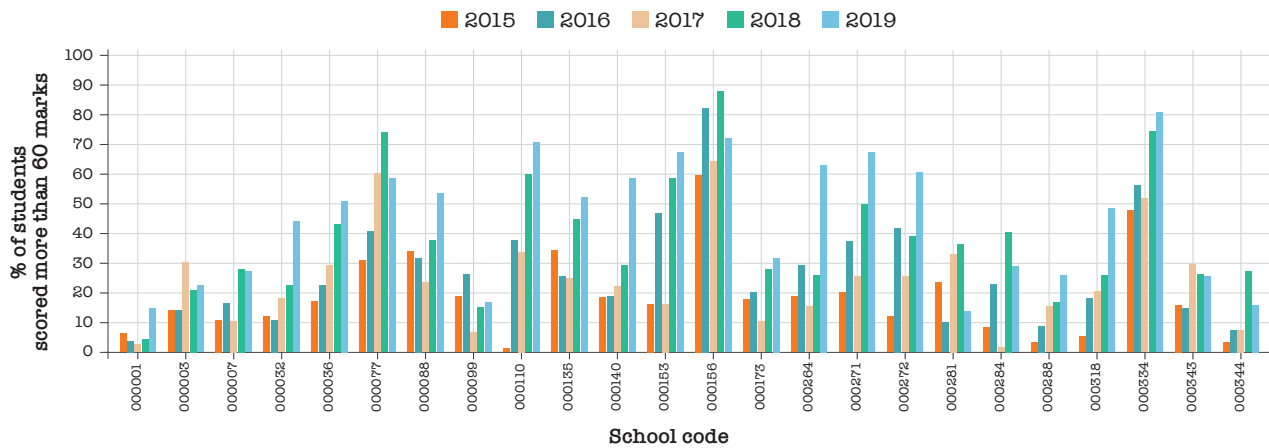
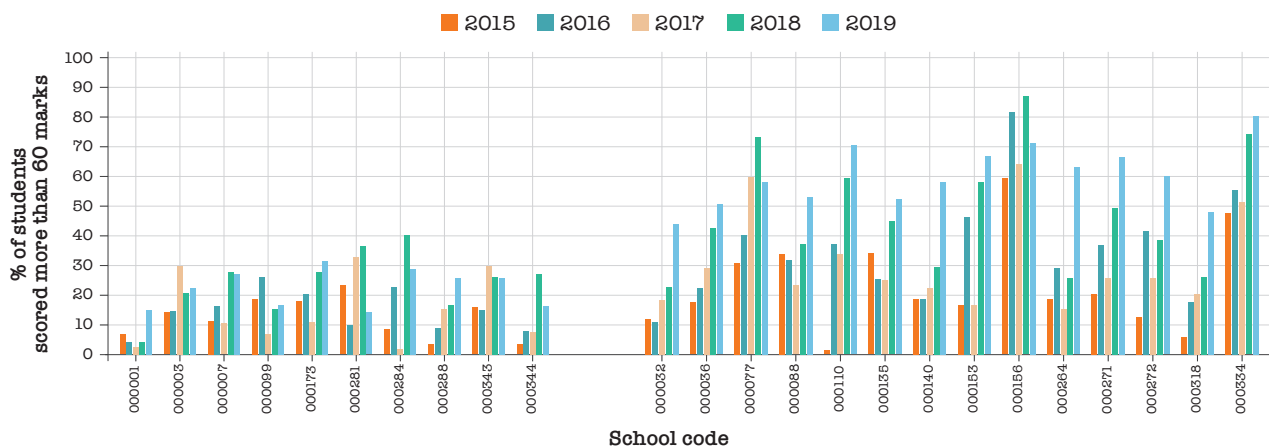

Figure 5.3



By putting one criterion that in 2019, bar height more than 30%, schools performed well gets separated into good and not good. Five bars for the same school represent scores in five years from 2015 to 2019 in the same order is consistently low. Notice, in such schools, the scores from 2015 to 2019 are also low. In the next 14 schools, more than 30% students have scored more than 60% marks in 2019 and there is an increasing trend from 2015 to 2019 in each school. With increasing number of years of teaching by the trained teacher, best result must come in the last year that is 2019. Therefore, to evaluate the teacher performance trained in TDC, we adopt two criteria: (1) students should score more than 60% marks 2019. (2) At least 30% of the students should score more than 60% marks in a school in 2019. We define "TRAINED PERFORMED WELL SCHOOL/TEACHER (A) where at least 30% the students have scored more than 60% marks in 2019. We define (B) where less than 30% students scoring more than 60% marks in 2019 as "TRAINED NOT PERFORMED WELL SCHOOL/TEACHER". The entire data of all the schools/teachers are analysed based on these criteria.

Results are given in Tables 5.1 and 5.2 for Mathematics and Science teachers/school performances, respectively. Nearly 60% to 62% of teachers have been successful in making at least 30% students appeared for SSLC mathematics and score more than 60%

marks in 2018 and 2019. In science, 66% teachers/schools are successful making the students score more than 60% marks in 2018 and 72% of schools/teachers in 2019. This in itself is significant.

Results given in Tables 5.1 and 5.2 prove several points in favour of teachers who are trained in TDC. More than 60% of trained teachers in mathematics are able to make at least 30% of students score more than 60% marks. Approximately 72.5% of trained science teachers are able to make 30% of students score more than 60% marks. Data showed that 49% of students in mathematics scored more than 60% marks in well-performed schools and 54% in science in the trained well-performed schools. These numbers are truly impressive.

We can analyze only the performance of the schools from the performance of students. If the school has a trained teacher at TDC, performance of the students is expected to be better than the schools where the teacher has not received training at TDC. Therefore, performance of the school is directly related to performance of the teacher in that school.

Table 5.1: Percentage of teachers/schools where more than 30% of students scored more than 60% marks in mathematics

Mathematics					
		2018		2019	
Sl. no.	District	Number of Schools	Well-performed Schools	Number of Schools	Well-performed Schools
1	Bagalkot	108	56 (51.9)	108	62 (57.4)
2	Belagavi	107	87 (81.3)	107	74 (69.16)
3	Bellari	115	70 (60.9)	145	68 (46.9)
4	Bengaluru Rural	42	27 (64.3)	42	29 (69.05)
5	Bidar	168	57 (33.9)	168	76 (45.2)
6	Chamarajanagar	36	17 (47.2)	34	15 (44.12)
7	Chikkaballapur	90	39 (43.3)	90	49 (54.4)
8	Chikkamagaluru	92	49 (53.3)	90	61 (67.8)
9	Chikkodi	99	90 (90.9)	99	83 (83.4)
10	Chitradurga	145	80 (55.2)	158	117 (74.05)
11	Davanagere	185	111 (60.0)	185	110 (59.5)
12	Dharwad	65	45 (69.2)	86	47 (54.6)
13	Gadag	83	39 (47.0)	105	31 (29.5)
14	Hassan	150	103 (68.7)	150	128 (85.3)
15	Haveri	88	59 (67.0)	88	61 (69.3)
16	Kalaburagi	118	56 (47.5)	131	61 (46.6)
17	Kodagu	34	11 (32.4)	34	8 (23.5)
18	Kolar	87	61 (70.1)	113	80 (70.8)
19	Koppal	89	53 (59.6)	99	58 (58.6)
20	Madhugiri	48	38 (79.2)	65	48 (73.8)
21	Mandya	76	38 (50.0)	97	72 (74.2)
22	Mangaluru	26	16 (61.5)	26	22 (84.6)
23	Mysuru	101	61 (60.4)	100	60 (60.0)
24	Raichur	126	61 (48.4)	145	41 (28.3)
25	Ramanagara	62	37 (59.7)	62	49 (79.1)
26	Shivamogga	50	25 (50.0)	89	47 (52.8)
27	Sirsi	50	35 (70.0)	50	33 (66.0)
28	Tumakuru	144	113 (78.5)	158	83 (52.3)
29	Udupi	55	49 (89.1)	55	48 (87.3)
30	Uttara Kannada	75	62 (82.7)	75	56 (74.7)
31	Vijayapura	72	58 (80.6)	72	43 (59.7)
		2786	1726	3026	1824
			61.95%		60.27%

Table 5.2: Percentage of teachers/schools where more than 30% of students scored more than 60% marks in science

Science					
		2018		2019	
Sl. no.	District	Number of Schools	Well-performed Schools	Number of Schools	Well-performed Schools
1	Bagalkot	110	80 (72.7)	110	59 (53.6)
2	Bellari	109	85 (78.0)	133	94 (70.7)
3	Belagavi	118	102 (86.4)	118	87 (73.7)
4	Bengaluru Rural	47	18 (38.3)	47	35 (74.5)
5	Bidar	154	48 (31.1)	155	77 (49.7)
6	Chamarajanagar	40	20 (50.0)	41	23 (56.1)
7	Chikkaballapur	97	38 (39.2)	97	74 (76.3)
8	Chikkamagaluru	100	30 (30.0)	95	62 (65.3)
9	Chikkodi	97	96 (99.0)	97	80 (82.5)
10	Chitradurga	144	112 (77.8)	158	148 (93.7)
11	Davanagere	190	120 (63.2)	188	168 (89.4)
12	Dharwad	61	47 (77.0)	76	45 (59.2)
13	Gadag	86	66 (76.7)	105	72 (68.6)
14	Hassan	143	71 (49.7)	141	124 (87.9)
15	Haveri	89	62 (69.7)	89	58 (65.1)
16	Kalaburagi	132	62 (47.0)	138	73 (52.9)
17	Kodagu	39	11 (28.2)	39	19 (48.7)
18	Kolar	91	66 (72.5)	117	98 (83.8)
19	Koppal	103	88 (85.4)	115	102 (88.7)
20	Madhugiri	48	43 (89.6)	57	45 (78.9)
21	Mandya	78	49 (62.8)	106	92 (86.8)
22	Mangaluru	19	5 (26.3)	19	17 (89.5)
23	Mysuru	95	58 (61.1)	94	60 (63.8)
24	Raichur	134	75 (56.0)	144	48 (33.3)
25	Ramanagara	49	37 (75.5)	49	38 (77.6)
26	Shivamogga	63	31 (49.2)	96	57 (59.4)
27	Sirsi	37	23 (62.2)	37	32 (86.5)
28	Tumakuru	130	79 (60.8)	144	106 (73.6)
29	Udupi	59	42 (71.2)	59	42 (71.2)
30	Uttara Kannada	83	63 (75.9)	82	70 (85.4)
31	Vijayapura	84	59 (70.2)	84	58 (69.1)
		2787	1842	2987	2168
			66.09%		72.58%

Performance of Teachers before and after Training at TDC

Year 2015 SSLC examination is important for the Karnataka school system. NCERT books got adopted a year or two earlier by the government and government-aided schools. All the schools had the same text books and same examination paper. Syllabus was uniform for all the government, government-aided and private schools. Medium can be English but books/contents of the subjects were same. There is a single examination (question paper) for all the students appearing for SSLC since 2015. Stricter examination rules not allowing the students copying, installation of CCTV cameras in examination halls were implemented from March 2015. From 2015, the education system in 8th, 9th and 10th class high schools have remained unchanged. Therefore, we take 2015 as the base year.

What is the expectation from a trained teacher? We expect the trained teacher to:

- a. Study and go to the class.
- b. Train the students to study and make him pass.
- c. Make sure that there is no copying by any student in any class examination.
- d. Do experiments and demonstrations in the class room/labs to make him learn science.
- e. Train every student score more marks which automatically

- increases passing percentage.
- f. Cover full text book in all the three years 8, 9 and 10 classes.
- g. Make sure that all the exercises in the book are answered, written correctly.
- h. Increase the students' skill to write the answers correctly and properly.
- i. During the class tests, not give part marks to train the students to write correct answers.
- j. Make the students to write correct answers to get full marks.
- k. Make more number of students score more marks – improve the full class.
- l. Make at least 40% of students in a class score more than 60% marks.
- m. Make at least 30% of students score more than 70% marks to compete with private schools.
- n. Make at least 25% of the students score 80% marks.
- o. Be truthful and make the students truthful.

All the above points are known to the teachers but what we in TDC do is to make the teachers practice them so that they can go back to schools and implement them in their respective schools.

Results given in table 5.1 and 5.2 prove several points in favour of teachers who are trained in TDC. More than 60% of trained teachers in mathematics are able to make at

least 30% of students score above 60% marks. A total of 72.5% of trained science teachers are able to make 30% of students score above 60% marks. Even though the criteria taken is 30% students should score more than 60% marks, 49% of students in mathematics scored above 60% marks in performed well schools and 54% in science in the trained performed well schools. These numbers are truly impressive. But there is scope for improvement.

The real question is how much the trained teachers are able to improve the performance of students compared to when they were not trained? How much the students of Karnataka gained in SSLC examination from the science and mathematics teachers trained at TDC?

To answer this, we have compiled total number of schools with science and mathematics teachers trained till December 2018. All these teachers have trained their students and prepared them to appear in SSLC examination in March 2019. In the year 2019 SSLC examination, 3155 schools of Karnataka had TDC trained mathematics teachers (see Table 5.3). TDC trained teachers in each of the 3155 schools with school code are compiled. The same schools had by and large the same teachers in 2015 in 3144 schools. About 700 teachers in mathematics were trained out of 3144 before Dec. 2014. This means most of the teachers in 3144 schools were not trained in mathematics when the students took SSLC examination in 2015 March. We take it that most of the teachers were untrained in 2015.

Table 5.3: Performance of teachers belonging to same set of schools before and after training

Mathematics						
Year of SSLC results	No. of schools	No. of students	No. of students scored more than 60% marks	percentage of students scored more than 60%	average percentage of marks	Increase in percentage who scored more than 60%
2015	3144	233204	58092	24.91	70.54%	$\frac{35.51-24.91}{24.91} =$
2019	3155	194042	68910	35.51	71.04%	42.55

Science						
Year of SSLC results	No. of schools	No. of students	No. of students scored more than 60% marks	percentage of students scored more than 60%	average percentage of marks	Increase in percentage who scored more than 60%
2015	3138	221525	61887	27.93	71.07%	$\frac{42.34-27.93}{27.93} =$
2019	3142	185030	78354	42.34	70.71%	51.6

Before the teachers were trained in 2015, about 24.9% students scored more than 60% in Mathematics. After the teachers in these schools trained, 35.1% students scored more than 60%. An increase of 42.55% ($[(35.51-24.91)/24.51]$) of students scored more than 60% marks. In science an increase of 51.6% students getting more than 60% marks is achieved after the teachers have received training in science. This is the overall result. The average marks scored both in science and mathematics has remained around 71% before and after the training. However, the number of students scoring more has increased. This is what was expected out of trained teachers and indeed, the expectation is realised. Copying effect can be ruled out because, scoring average 71% marks is not possible by unfair practices of such a large number of students. When we showed the results to the Secretaries of the Education department and other officials, they do ask this question: what is the effect of copying? That is why this point is written here specifically.

We can now put the condition that at least 30% of students in a school must get above 60% marks. Let us examine how many teachers are able to achieve this.

In 2019, in 1835 schools out of 3155 schools, at least 30% students have scored above 60% marks as given in Table 5.4. Number of students appeared for SSLC in 1835 schools is 109719 out of which 54153 students scored more than 60% marks in mathematics. Thus, 49.35% of students got more than 60% marks. Average % marks is 71.6%. In 2015, percentage of students scoring more than 60% marks is 30.4% before the teachers were trained and it has increased to 49.4% in 2019 after the teachers in those schools have received training in TDC. The net increase in the students coring more than 60% is 62%. This is achieved mainly due to the performance of teachers after the training. Number of students appearing for SSLC in the state decreased by about 80000 from 2015 to 2019. Here also number of students appeared in 2019 has decreased by about 20000. In spite of it, additional 14,404 (54153-39749) students could score more than 60% marks because of the trained teachers. Barring 2017, there is a steady increase in the % of students getting more than 60% marks because the teachers trained increased from 2015 to 2018. The year 2017 was considered difficult for mathematics, well-recognised by the government education department.

Table 5.4: Performance of teachers belonging to same set of schools before and after training with at least 30% students scoring above 60%

Mathematics							
Year of SSLC results	No. of schools	No. of schools performed well (A)	No. of students	No. of students scored more than 60% marks	percentage of students scored more than 60%	average percentage of marks	Increase in percentage who scored more than 60%
2015	3144	1832	130510	39749	30.46	71.00%	$\frac{49.36 - 30.46}{30.46} = 62.01$
2016	3155	1834	125987	48671	38.63	73.20%	
2017	3158	1835	121266	36068	29.74	71.40%	
2018	3159	1835	116674	49139	42.12	71.20%	
2019	3155	1835	109719	54153	49.35	71.60%	

Science							
Year of SSLC results	No. of schools	No. of schools performed well (A)	No. of students	No. of students scored more than 60% marks	percentage of students scored more than 60%	average percentage of marks	Increase in percentage who scored more than 60%
2015	3138	2175	146110	47437	32.47	71.50%	$\frac{54.45 - 32.47}{32.47} = 53.45$
2016	3151	2182	141038	48858	34.64	71.18%	
2017	3150	2182	135407	71252	52.62	71.42%	
2018	3152	2183	131552	59487	45.22	70.88%	
2019	3142	2183	123954	67499	54.45	71.14%	

Exactly similar analysis is done for the science teachers before and after training in the same set of schools. In 2019, 3142 schools have trained science teachers. In 2183 schools out of 3142 at least 30% of students have scored above 60% marks in science. 123954 students have appeared for SSLC from 2183 schools and 67499 students have scored more than 60%.

This is 54.5%. Actual average score in science is 71.14%. In 2015, out of 3138 schools, 2175 schools from among the 2183 are taken for performance analysis. It is the 2175 school teachers out of 3138 school teachers (school code wise) were not trained in 2015. 2175 schools are the same schools out of 2183 schools. Number of students appeared for SSLC in 2175 schools

is 146110 out of which only 41437 students (32.5%) have scored more than 60% marks in 2015. Thus, increase in the percentage of students scoring more than 60% ($[(54.5-32.50/32.5) \times 100]$) is 53.5% after the same teachers received training in Science. The number of students who have gained from trained teachers is about 20,062 (67499-47437). Only assumption here is that quality of students in 2015 and 2019 has remained same. Therefore, the teachers are able to make a greater number of students score more than 60% marks. Average marks in each subject has increased marginally by 1% to 1.5% over 70%. Our aim was to see that in a class, more number of students should score more marks. This approach made more students pass on their own. Overall quality of teaching should be better. To make a few students score very high marks depends on the the extra effort by the teacher and the students' extra effort. We did not address this in our training.

The results can be looked at by another angle. Take a school where there are 50 SSLC students who appear in 2015. Out of this, 16 students would have scored 60% and above marks in 2015. In 2019, after the teacher has received training and if the number of students in the school is 50, 27 students have scored more than 60% marks. This is the impact of the trained teachers on the students.

To see if the trained teachers are able to bring even better results, making at least 25% students score more than 70%. In Table 5.5 we show the data. In 24% of schools that is 752 schools out of 3155 schools with trained teachers, in 2019, 39.31 students scored more than 70% marks. In 2015, in the same 752 schools, before the teachers were trained, 19.59% students scored more than 70% marks. This is clearly 100% increase which is remarkable. In science also net increase in making the students score more than 70% is

Table 5.5 Performance of same schools/teachers before and after training

Mathematics						
Year of SSLC results	No. of schools	No. of schools performed well (A)	No. of students	No. of students scored more than 70% marks	percentage of students scored more than 70%	Increase in percentage who scored more than 70%
2015	3140	752	50008	9797	19.59	$\frac{39.31-19.59}{19.59} = 100\%$
2019	3155	752	43448	17078	39.31	

Science						
Year of SSLC results	No. of schools	No. of schools performed well (A)	No. of students	No. of students scored more than 70% marks	percentage of students scored more than 70%	Increase in percentage who scored more than 70%
2015	3128	1020	62635	13049	20.83	$\frac{42 - 20.83}{20.83} = 101\%$
2019	3142	1021	53977	22661	42.00	

over 100%. Objectives of training the teachers to make an impact on quality teaching and more students scoring higher marks is definitely realised.

In Figure 5.4 and 5.5 the results are shown graphically for individual districts. Percentage of students scoring more than 60 is given in the bar diagram against a district. The shorter blue bar is for the results of teachers/schools before training that is in 2015 and the longer (red) bar is for the year 2019. Results show that increase in the performance of the students has taken place in all the districts.

Figure 5.4. Plot of % students getting more than 60% marks before and after the teacher trained at TDC. General perception is that it is difficult to score 60 % and above by copying. 70% is even more difficult. Therefore, the results are reliable. Thus, the impact of trained teachers on the students is by way of a greater number of students scoring a higher percentage of marks in SSLC.

These numbers compare well with the private unaided schools. Therefore, government and government-aided schools are able to perform well in

Figure 5.4

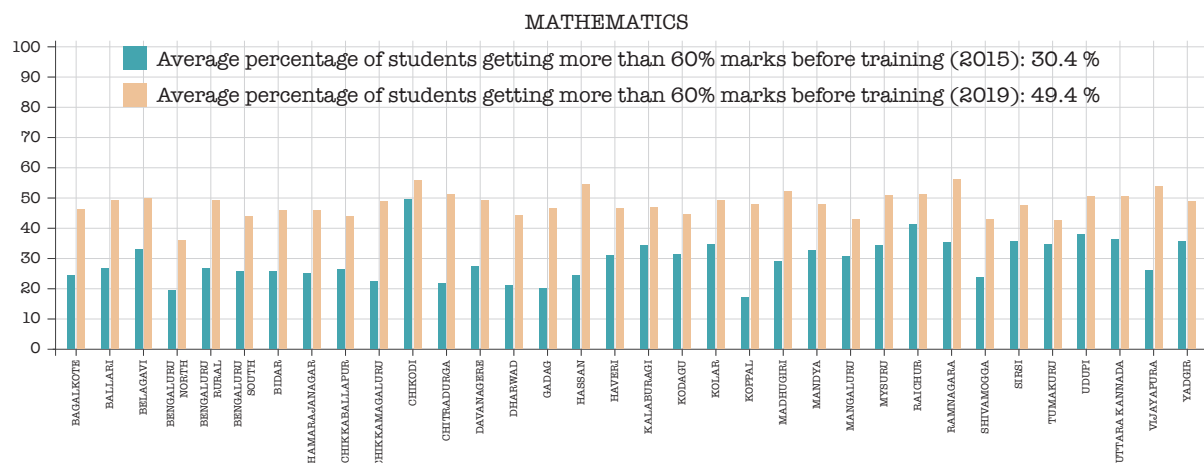
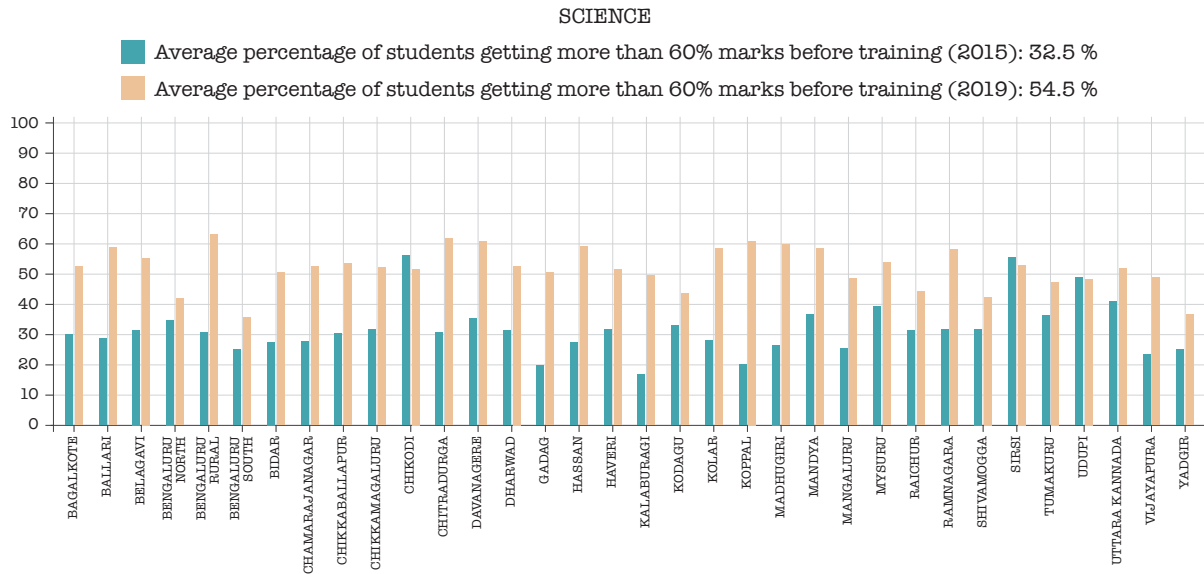

Figure 5.5



spite of poorer levels of students they admit at 8th class compared to private schools. Credit goes to teachers. Training indeed brings out talent among the teachers.

criterion of at least 30% of students scoring more than 60% marks in mathematics and science in the year 2018 and 2019. School code is given against each set of bars.

Yet another way to find the performance of trained teachers before and after the training is to see the progression they make year by year. In Figure 5.6, we have shown one backward district Chitradurga where IISc is situated. In this figure, we have plotted the % of students scoring more than 60% marks from 2015 to 2019 taking a simple

It has been clearly depicted in Figure 5.6 that the % of students scoring more than 60% is increasing year by year. Contrary to this, those schools/teachers not successful to meet this criterion given in bottom part of the same subject of figure 5.6 shows the contrast.

Figure 5.6

Chitradurga District					
Subject – Mathematics					
Year of SSLC results	Number of schools (teachers) trained	Number of schools, which performed well A	Number of schools, which did not perform well B	Percentage of students who scored more than 60% marks B	Percentage of students who scored more than 60% marks A
2018	145 (189)	80 (55.1%)	65 (44.8%)	18.0%	49.4%
2019	160 (215)	118 (73.7%)	42 (26.3%)	20.0%	52.2%

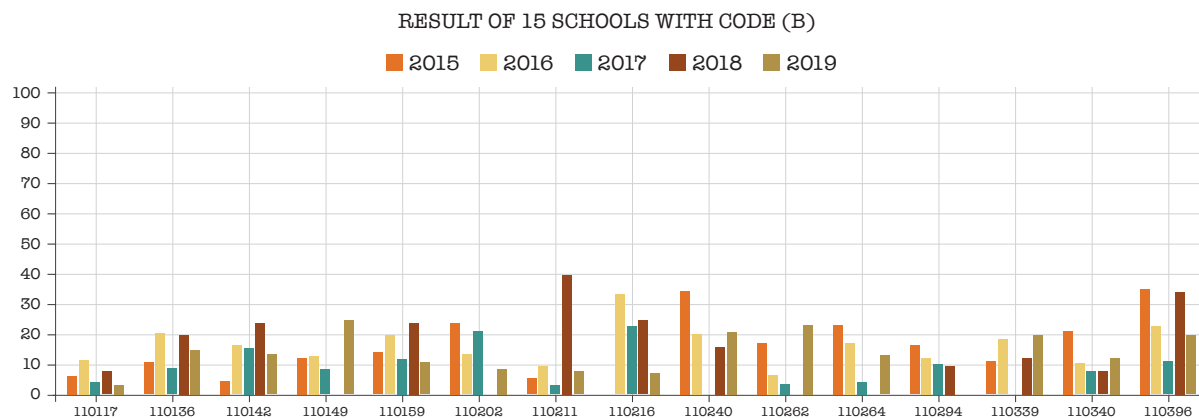
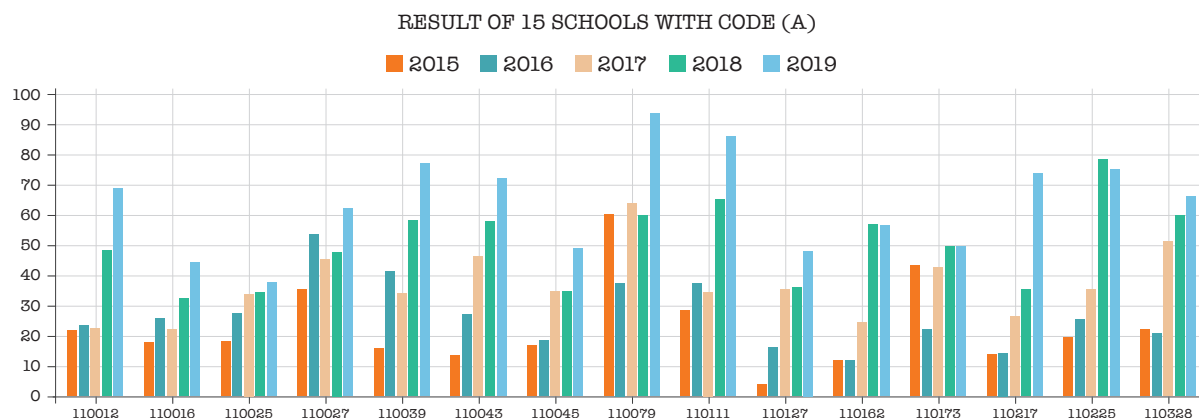

Chitradurga District					
Subject – Science					
Year of SSLC results	Number of schools (teachers) trained	Number of schools, which performed well A	Number of schools, which did not perform well B	Percentage of students who scored more than 60% marks B	Percentage of students who scored more than 60% marks A
2018	144 (182)	112 (77.8%)	32 (22.2%)	21.8%	58.5%
2019	167 (221)	156 (93.4%)	11 (6.6%)	24.5%	63.7%

RESULT OF 10 SCHOOLS WITH CODE (A)

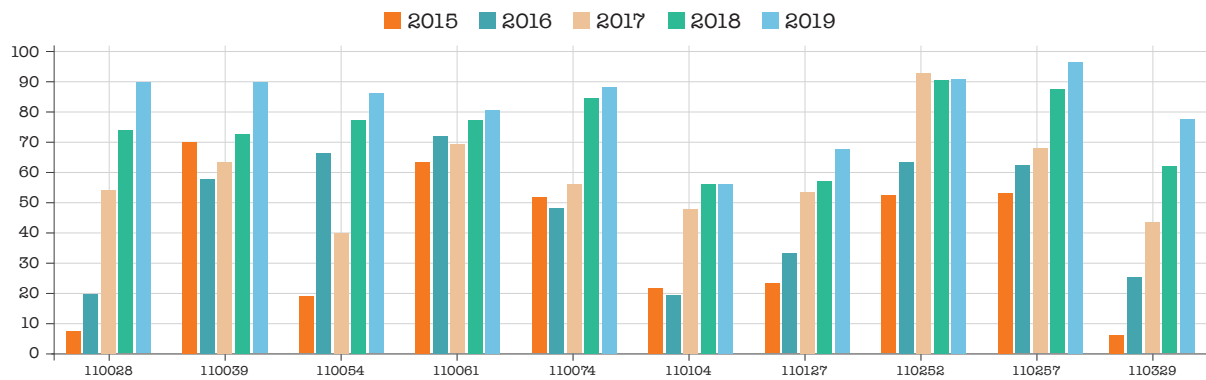

RESULT OF 10 SCHOOLS WITH CODE (B)

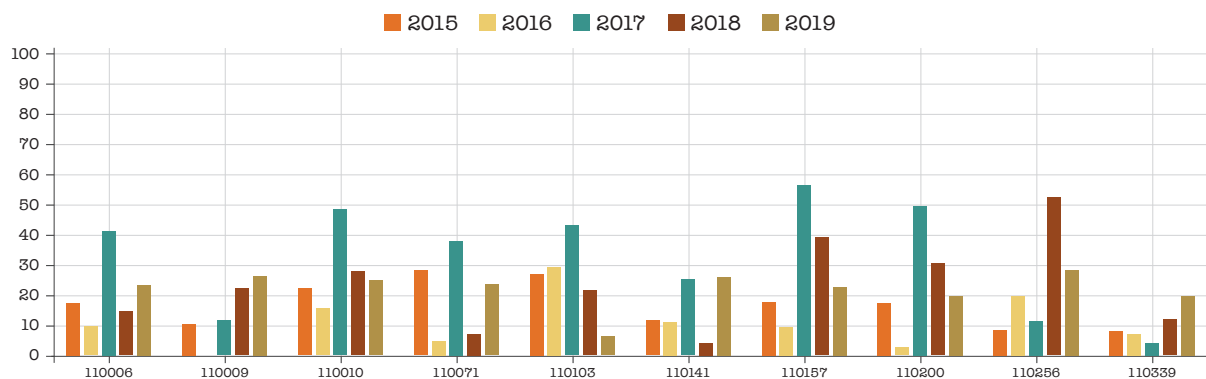

Smaller heights indicate poorer performance. A district like Chitradurga doing so well is indeed satisfying because TDC, IISc established in Challakere, Chitradurga district. Influence of TDC on the students via trained teachers is truly significant.

In conclusion, teachers after training have produced desired results. The number of schools where we have trained teachers is almost 50% in Karnataka. If all the schools have trained teachers, impact will be huge in terms of quality education the students receive. If the teachers who are not doing well can be trained again and the performance of the students will further improve. Even now, number of students scoring more than 70% marks from the trained successful teachers is very high. Analysis of results show that the performance of Govt. schools is comparable to the private schools. Certainly, objective of improving quality of learning in Govt. schools is realised by training the teachers at TDC, IISc.

In addition to the improvement of scores of students in SSLC, attitude of teachers changing from making the student just pass to make them score more is a satisfying feeling. Inherent competition among the schools is picking up. Government is now asking the schools to make more number of students score more than 60% by sending circulars. This must be traced to our recommendation to

the Govt. in our report. Conscious effort to acquire good experimental facilities is increasing. Discipline, time consciousness is increasing. 'Prepare and go to class' is also increasing. Many teachers described how one to two hours they spend on Sunday to plan for the coming week. They show their note books on new problems to be given to the children. Percentage of teachers performing well is also increasing. Periodic meeting at district level with the teachers by TDC faculty may further add to improve the quality of learning further. Visits to a large number of schools also give a feedback. There is an atmosphere of learning. Teachers are confident of their students. They ask us to go into the class find the response of students. Many methods introduced in TDC are visible. Laboratories are getting equipped. Teacher show how they improved science learning by demonstrations. Some teachers even express: copying and making the students is no longer required. Year by year improvement is truly an encouraging sign. Teachers in the schools look distantly happy. Success of TDC goes to teachers.

PU College Science and Mathematics Teachers' Training

It was December 2011 to February 2012. The Govt. of Karnataka decided to adopt NCERT text books to PU Science. Reasons for shifting to NCERT text books with CBSE syllabus from state syllabus were curious. For Medical and BTech/BE admission, students passing PU should appear for Common Entrance Test (CET) and a merit list is drawn with 50% PU marks and 50% CET marks. Bangalore has ~15% population of Karnataka and ~15% of students in PU come from Bangalore. Due to the help received from private tuition to clear CET, 80% of engineering and medical seats used to be cornered by the students from Bangalore. Private tuition lobby as it has come to be known was very strong in influencing the CET testing groups in PU Dept. Even though the content for CET test was state syllabus for PU, the tuition lobby would carefully widen the

scope to cover CBSE NCERT books in the tuition classes. Such a facility was not available to 85% of PU students of Karnataka. The Govt. understood the method adopted by private tuition lobby and prescribed NCERT text books to all the PU students of Karnataka. All the students now have the same advantage because all have the same book to master. Yet, the teachers from the PU colleges went on strike opposing implementation of NCERT text books for PU. Reason for the strike by the teachers was they are not having enough knowledge to teach the new books. The Karnataka Govt. approached IISc to train their PU college teachers and that was the beginning of TDC taking up PU college teachers' training in PCMB.

At the request of the PU Board, Training Need Analysis (TNA) was carried

out with 100 representative teachers 25 each from PCMB in Feb. 2012. We conducted two days program to assess the teachers' knowledge through written test, ability to do PU laboratory experiments, experiments skills and a short oral examination. Experienced teachers from IISc gave lectures on one topic in each subject. We had shown the PU teachers how the new method of learning science by doing experiments and learn mathematics by solving problems is helpful to gain knowledge to become better PU teachers. Analysis showed that teachers scored about 20% marks in all the PCMB subjects proving that they need a rigorous training. The government requested IISc to train PU teachers at TDC. IISc has trained 2350 State Govt. PU college teachers teaching PCMB. Approximately 600 colleges of Karnataka have PU teachers trained in TDC, IISc.

Soon, Jawahar Navodaya Vidyalaya (JNV) Samiti PU or PG teachers came for training in TDC. We were tested initially on our ability to give good content enriching training in physics, chemistry, biology and mathematics. The JNV Samiti sent best result school teachers in 2013 without telling us. We only found it out by their performance. This also helped us to raise our standard or come out of the State PU teachers' level. In next one year, KV school PG teachers teaching basic sciences also came to TDC for training. KV teachers' training was even more a challenge

because their perception was that they are the best.

We had an unusual experience during the TNA with 100 teachers. It may be worth telling. To test the ability to do the experiments prescribed in the curriculum of PU science, we arranged over 15 experiments to the physics participants. They were given choice of picking the experiment. Most of them picked determination of "g" by simple pendulum. I was watching them doing experiments sitting in a corner of the hall. They were swinging the pendulum widely with angles well over 30°. Almost all of them did not measure time nor the length. They completed the experiments and submitted the report. All of them had several readings in their reports. And they all got g value equal to perfect 9.81 ms^{-2} . We then asked a few to measure g in front of us. They were reluctant. On insistence they could not reproduce what they had written in their report. All of them had cooked up the results what is commonly known as back calculation and wrote the report. This was shocking and we almost decided that we will not conduct training program to PU teachers. However, some of my senior colleagues intervened: when we train, we will change the question to be answered in each experiment.

What is the take home lesson? Science experiments are not carried out honestly. Spirit of verifying principles by doing experiments is killed at the

first occasion. Students are not made to learn doing experiments correctly and honestly. They are taught how to cook up results and dishonesty. This conclusion is valid even in JNV and KV schools. Making the teachers knowledgeable is not sufficient. Major effort is to make them honest.

Mathematics Training Program for PU Teachers

In 10 to 12 days, 10 modules/topics covered are as follows:

- a. Sets, relations and mathematical induction;
- b. Trigonometric and inverse trigonometric functions;
- c. Limits and continuity; Differentiation and applications;
- d. Integration and application; Differential equations;
- e. Lines and conics, 3-D geometry and vector algebra;
- f. Counting and Binomial Theorem;
- g. Complex numbers;
- h. Linear programming;
- i. Statistics and probability; and
- j. Determinants and matrices.

These modules cover entire 11 and 12 or PU subjects. On each of the topics, lectures are given by the Professors of IISc. One-hour lecture is followed by an assignment covered in that lecture. Problems in the assignment are chosen with increasing degree of difficulty. Problems are within the

syllabus of PU but far beyond the books. On average, on each topic, 30 to 40 problems are given. Teachers are provided competent assistants to help the teachers clear their doubts and make the teachers solve the problems, make them write neatly each of the problem properly. Completeness of the assignment writing is verified. Then they move to next module. Everyday morning a short test on each module for 30 min is given to assess the extent of learning the teachers have accomplished. Those who are not able to do well are given one on one training in the evening after 6 pm. Training is made fully interactive and enjoyable. Teachers indeed work because they need knowledge and there is a huge desire to learn.

It is generally felt that if the program is made rigorous teachers may not like. Opposite is true. Yes. Initially, since the teachers are not used to doing hard work, they find it difficult. Once the teachers experience happiness in learning what they need to learn, almost all start working to succeed. At the end they express that this was the best content enrichment training they have attended so far.

It may not be out of place to mention what a student appreciates most in IIT Kanpur. At the end of 60 to 70 courses a student takes to complete BTech, ask him which course he liked most. Answers of hundreds of good students used to be the most difficult

one (EE301- Electronics I by Professor R. N. Biswas) where they needed to work hard to learn and indeed they learnt because the teacher was good and made them learn. Similar is the sentiment and atmosphere that get developed in TDC.

PU Teachers' Training Program – Physics, Chemistry and Biology

Two lectures in the morning each day for 10 to 12 days covers all the subjects in the 11 and 12 class text books. Remaining 6 to 8 hours each day, teachers do experiments on the theory that is taught with demonstration in the class room. The experiments cover over 85% of the subjects they need to teach. It is a bit hectic because 6 to 7 experiments have to be done each day. That is where the TDC has put in a lot of effort as to how they can do more experiments in a shorter time. Experiments and instruments are simplified. Moved into digital equipment. New instruments are designed to bring in most of the concepts to learn by observations and experiments. Care is taken that the results they get are what is expected from standard tables and books. This is one of the strong inputs by the TDC to the teachers. In the normal PU program, a small number of experiments are prescribed. Most PU colleges do not have facilities for all the students to do even these small

number of experiments. Most teachers have not performed experiments which are essential to understand theory. Learning science by doing experiments is a new refreshing experience for the teachers in TDC.

Why teachers learn by doing experiments? Because, experiments take more time compared to teaching the same concept in the class room. Therefore, more time to grasp a topic. For example, take Planck's equation $E = hv = hc/\lambda$ Joules = $hc/\lambda eV$. Measurement of wavelength of light experimentally, line spectrum vs continuum, intensity, wavelength and colour associated with wavelength of light or frequency, substitution of individual terms in the equation, calculation to get the right value of E in Joules up to 3 decimal places, conversion of energy from Joules to eV, evaluation of energy for more number of photons, variation of energies as a function of wavelength, all put together make the teacher understand the concept. Repeating the energy determination for four to five wavelengths make them remember the formula. Variation of energy with λ , calculation of E of X-ray, and microwave photons completes electromagnetic spectrum. All this in about 1 hour. Now you frame any kind of problem, they will solve. This is all about CET test. Add the knowledge gained from 80 such experiments done and studied in parallel with class room formal lectures with demonstration,

the teachers learn the subject firmly than without experiments.

In the evening the teachers are handed out an assignment based on the subject they studied during the day. Next day they submit the assignment and by evening they are corrected and given back. When the questions in the assignment were based only on the theory lectures, teachers found them very difficult. On the contrary, any kind of problems even the difficult ones originated with the experiments given to them, almost all the teachers finish answering assignments before dinner by 8 pm. They have a feel for the subject when they do experiments. This was realised in the early stages of training teachers in TDC. Indeed, learning science by doing experiments works.

A large number of experiments had to be developed to cover 11th and 12th class physics, chemistry and biology subjects within their text books. Experiments done by the teachers are not just those prescribed for the students in PU syllabus. New experiments are to be designed to make the teachers understand the theory in each subject. Over 80 experiments each in biology, physics and chemistry have been designed in TDC. Short write-ups on the experiments are given in Appendix B at the end of the book. Most of the experiments are designed and developed at TDC.

It is not possible to cover the vast number of subjects the PU book have in just 12 days. But the teachers are not students. In any lecture, professors directly go the difficult part of the subjects after covering the preliminaries. Many of the subjects are directly covered in the laboratory experiments. Combined course with lectures, laboratories and assignments writing, discussion on that will cover almost what the teachers' needs to know to make up the deficiency or gaps in their knowledge.

One of the things we insist is writing correctly and completely the answers to the questions. At the end, students have to pass a written examination. To train the students, teacher must write everything correctly. We totally discourage giving part marks. This is the reason why teachers in the pretest do not get marks. Since they have not gone through a rigorous BSc, MSc training, they lack the present-day requirement to be perfect to be competitive.

Due to lack of rigour in the doing experiments and idea of learning theory through experiments have not developed in India. We have found that it is lot easier to lean theory by doing experiments and get a feel for the subject. Honesty in general and honesty of reporting results is very important to develop right attitude to learn. This is what we emphasise in the training program. The teachers who come for training finally understand and appreciate it.

Experience with PU PG Teachers' Performance

Introducing test was a novel idea for both the trainees and trainers. Both the groups have to perform. The first test is essentially on what the teacher is supposed to know. We give a test on the first hour on the first day. The paper is a typical PU paper demanding exact answers, no choice, no multiple-choice answers, and no part marking. So far not a single teacher refused to take a test and hence onus of making them good is on the TDC faculty. Not a

single teacher so far in any test on any subject said the questions are outside the syllabus. After a rigorous training a second test of the same level as the first test is given to assess the knowledge they have gained. The second test is essentially a test for the TDC faculty. In the following 12 bar diagrams, teacher number in the x-axis and marks in the pretest in blue bar (small height), and marks in the post-test in red bar (higher height) are given for Karnataka, JNV and KV PU PG teachers for four subjects each .

Karnataka PU Physics Lecturer's (02-07-2013 to 11-07-2013)

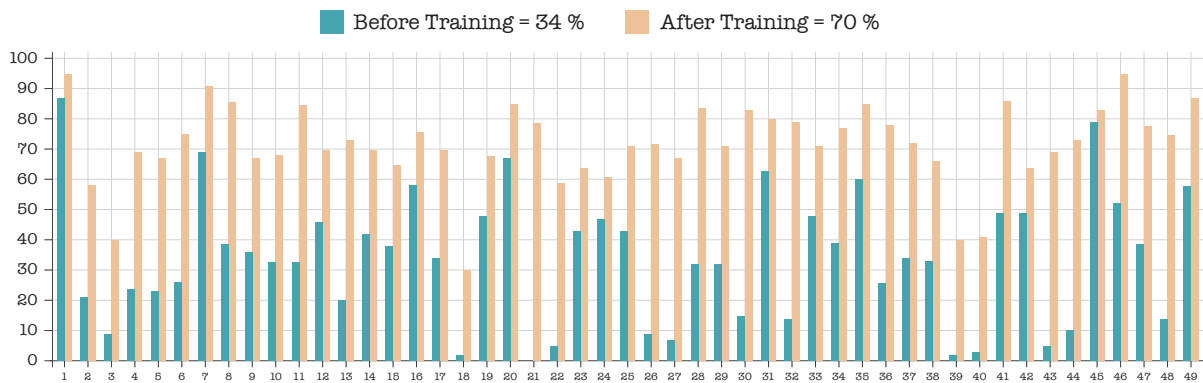

Karnataka PU Chemistry Lecturer's (08-06-2013 to 17-06-2013)

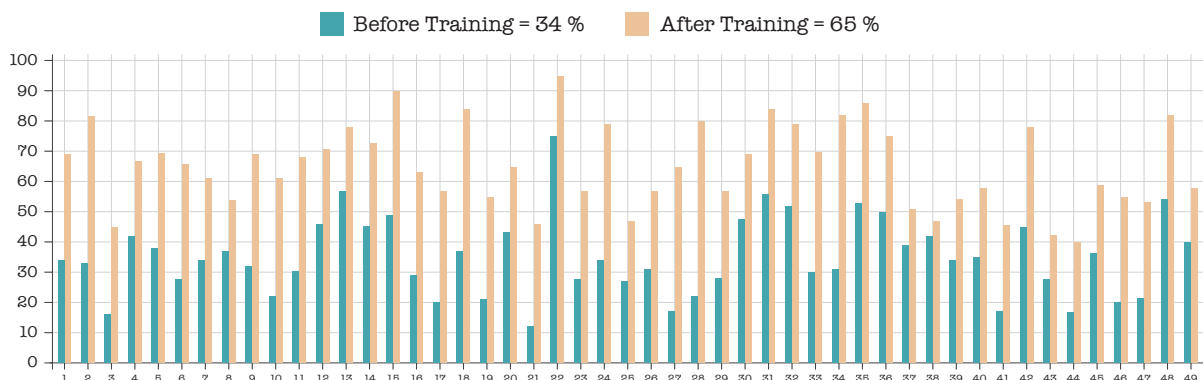

Karnataka PU Mathematics Lecturer's (08-06-2013 to 17-06-2013)

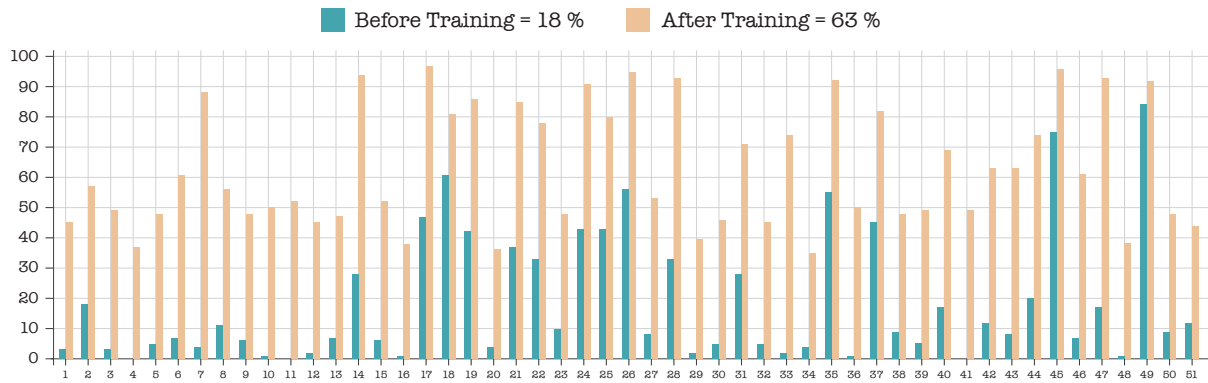

Karnataka PU Biology Lecturer's (02-07-2013 to 11-07-2013)

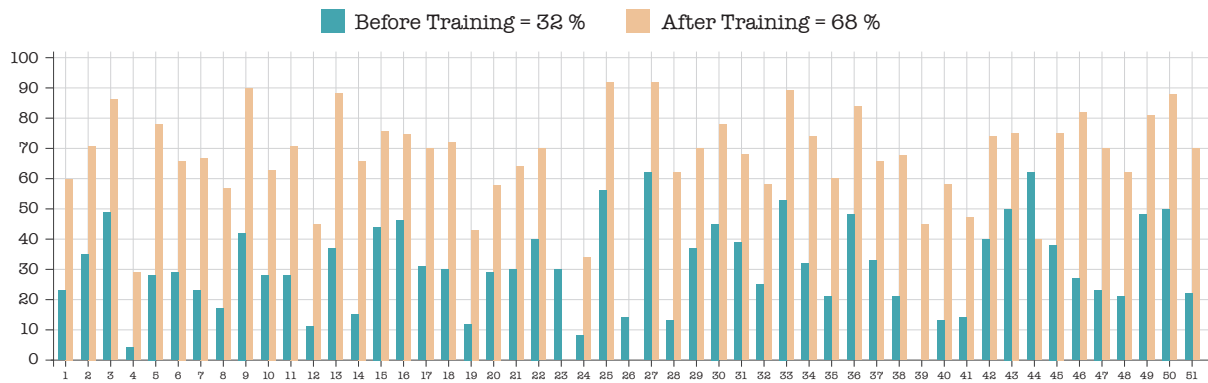

PGT JNV Lecturers in Physics (14-05-2019 to 23-05-2019)

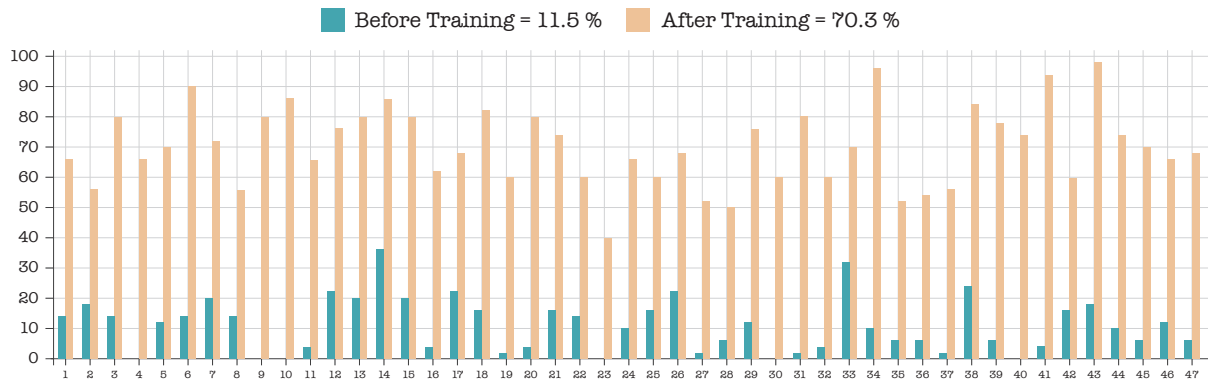

PGT JNV Lecturers in Chemistry (05-06-2019 to 14-06-2019)

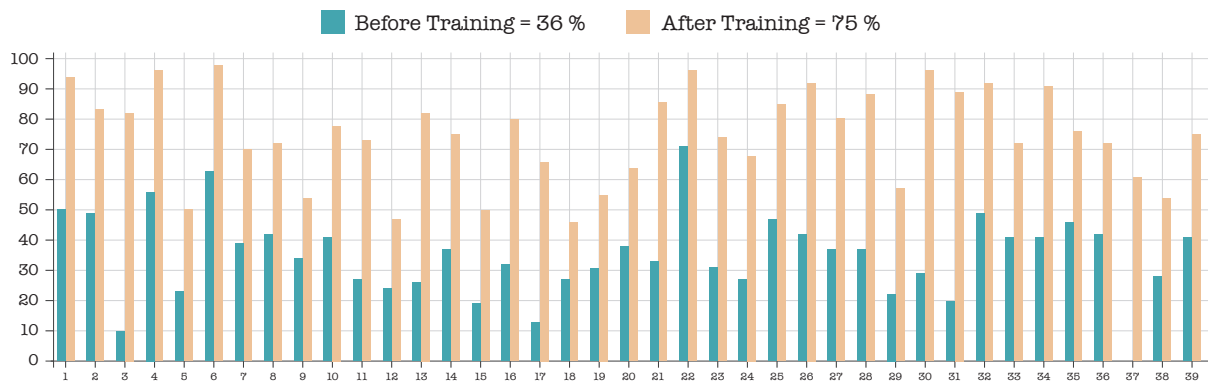

PGT JNV Lecturers in Mathematics (05-06-2019 to 14-06-2019)

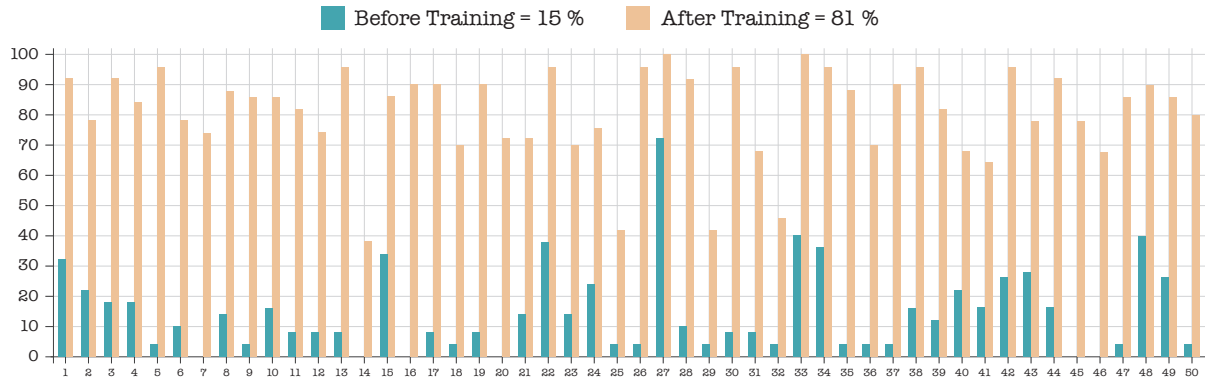

PGT JNV Lecturers in Biology (14-05-2019 to 23-05-2019)

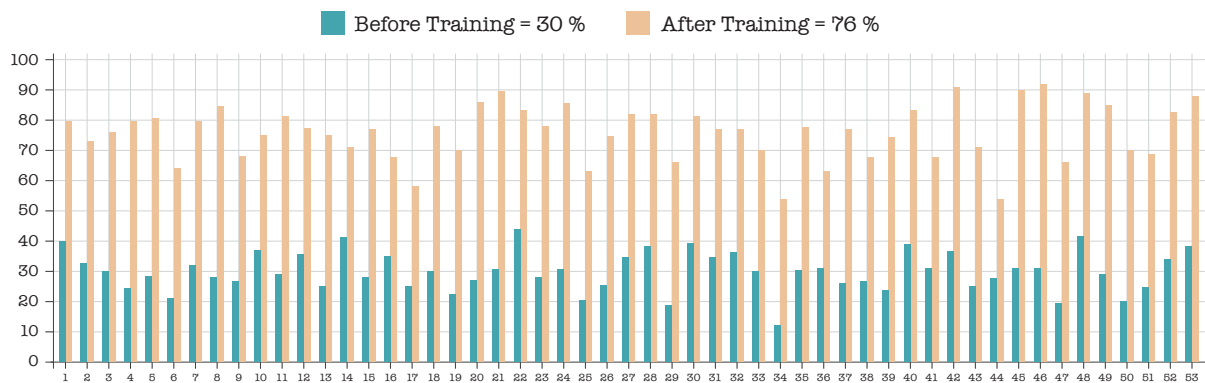

Kendriya Vidyalaya Physics Teachers (14-05-2018 to 25-05-2018)

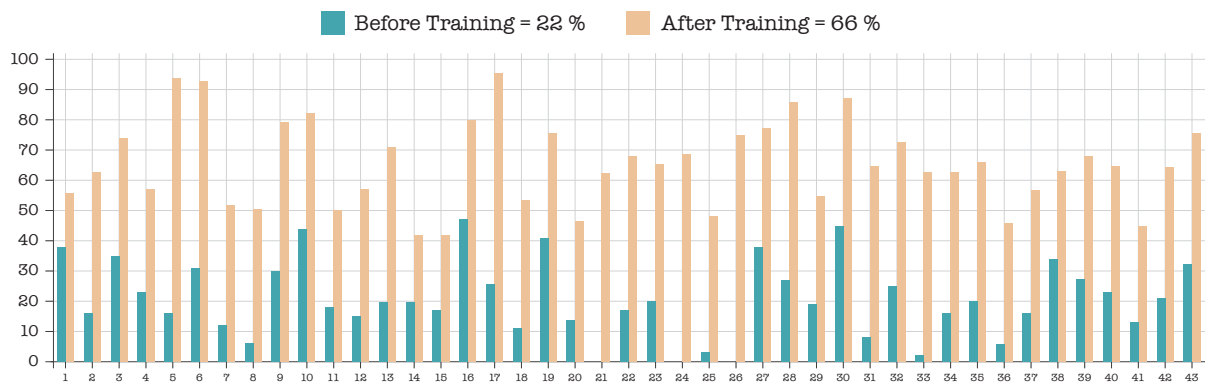

Kendriya Vidyalaya Chemistry Teachers (26-05-2018 to 06-06-2018)

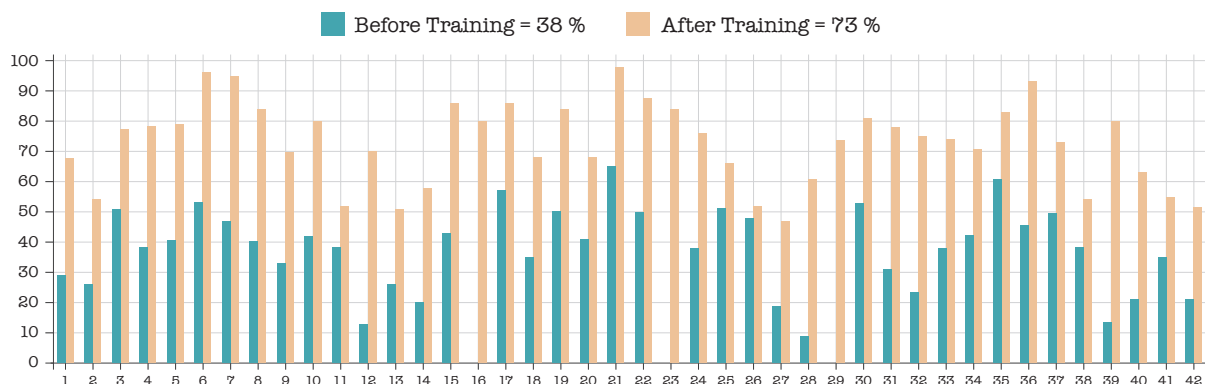

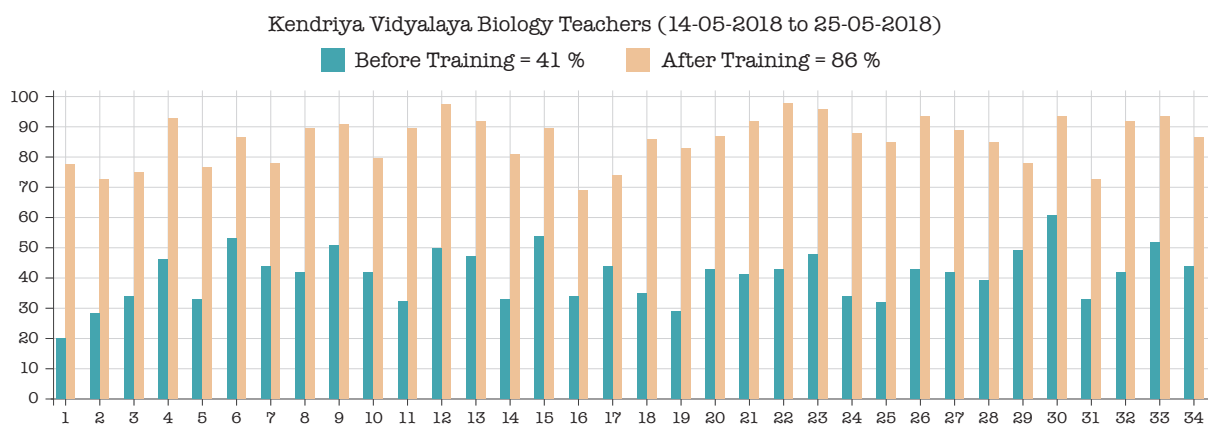
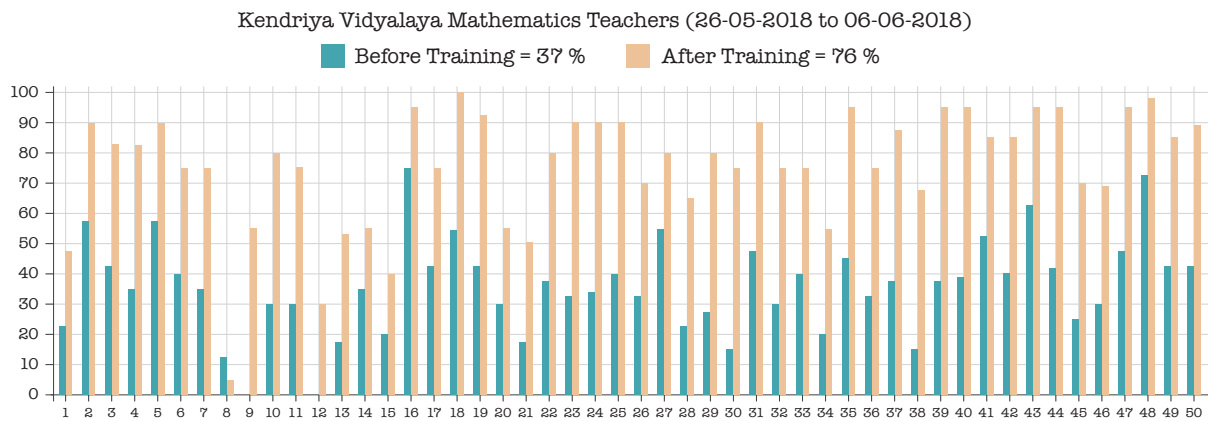

The graph above clearly indicated a huge improvement by all the participants. There is scope for further improvement. But one thing is clear. All the three groups of teachers needed training including the KV 11 and 12 class teachers. This can have a significant impact on the level of learning on the students.

Since 2012 to 2019, a total of 3927 PU teachers have been trained in TDC. Teachers trained in individual subjects

and the total number are given in the table 6.1. KV and JNV come from all over India.

There are a few feed backs. One mathematics teacher Mr Anand from Ongole in Andhra Pradesh JNV came for training in 2013. He again came in 2015. He gave us a letter how he could improve the results by the training he received. In 2012 and 2013, average marks scored in his school in mathematics CBSE 12 was about 60%. After the training in 2013,

Table 6.1: Number of PU PG teachers trained at TDC, IISc Challakere.

PU	Physics	Biology	Chemistry	Mathematics	Total
Karnataka PU	625	587	552	568	2332
JNV	310	257	246	330	1143
KV	91	71	138	152	452
Total	1026	915	936	1050	3927

average marks scored in mathematics in 2014 and 2015 is 80%. Very fact that both JNV and KV school systems want to send their teachers regularly confirms the quality of training. Mr Vishvakarma from JNV Banaras came for training in 2018 and took the first test. We were looking at the results and his score was 66% whereas the average was about 35%. He continued to work in the program and last test he scored 98. He looked to have come earlier and indeed he had come for the second time. His final marks in the first training was 65. The story tells that the teachers retain knowledge gained in the training and do better when they come again. A systematic study on the impact of training on the students however needs to be done for PU teachers.

Many JNV schools are acquiring the PU science kits and impact of experiments on the students is also confirmed to be very high.

If the PU teachers have the laboratory equipment for them to demonstrate

experiments to the students, we are sure, level of learning will be much higher with the trained teachers at TDC.

BSc Degree College Teachers' Training at TDC

Idea of training basic science teachers from high school to University was conceived in 2011 when TDC was started in new IISc campus at Challakere. High school and PU college teachers' training programs were stabilised by the end of December, 2014. IISc was organising all India level UGC refresher courses for MSc/ University teachers for a long time. However, the BSc degree college teachers' training was new to IISc. Training method and implementation was too complex which was not anticipated by TDC at the end of 2014.

On 18th February 2015, the Honorable Prime Minister of India visited Indian Institute of Science, Bangalore. Research and development programs of IISc were presented to him along with its programs of social commitment to the nation by way of high school

teachers' training at TDC in its new campus. Instantly he picked up teachers, training and got instituted in IISc a "Centre of Excellence in Science and Mathematics Education" under MHRD initiative, Pandit Madan Mohan Malviya National Mission on Teachers and Teaching (PMMMNTT). The MHRD initiative in 2015 helped TDC to take up BSc UG degree college and MSc PG teachers' training programs for science and mathematics teachers. MHRD under PMMMNTT was keen on training UG and PG teachers under higher education sector.

A Perspective on BSc Degree in Science

Students who could not make it to four-year professional degree courses

opt for three year BSc degree colleges under State Universities. Students go to Engineering and Medical education in preference to basic science education. It is ironical that lower scoring students at PU take up science education to do BSc and MSc and these are the ones who teach science subjects in India. Science includes mathematics.

Yet, all is not lost in basic science education to professional engineering and medical education. Good number of students from rural and semi-rural parts of India who have less financial resources opt for BSc to MSc to PhD route to higher education. In fact, analysis of students admitted to PhD degree both in Science and Engineering in IISc shows that over 75% come from rural and semi-urban parts of India. These students are highly motivated to acquire higher knowledge. They are ready to accept fewer promising careers because most of them are first-time degree holders in their respective surroundings. Opportunity to study in colleges and universities is perceived as huge opportunity to come up from these smaller rural and semi urban places. Another set of students who come for higher studies especially for PhD are those who realise research is important after one to two years of working as teachers in degree colleges. They are truly interested in higher studies. The third set of students who come to do PhD in science are engineering graduates purely due to their interest in

science. These students are having best of both worlds: they have engineering and science background to excel in science. And indeed, they contribute to research and development.

There are over 100 colleges which are rated high in India such as Presidency College, Calcutta, Chennai, Agra College Agra, St. Josephs College Bangalore to name a few. Delhi University, highly rated for UG studies is fashioned on the British University model. It is a Central University in Delhi and has stake in producing quality students. All the teachers hold PhD degree. Many such colleges not necessarily centrally funded have PG courses leading to MSc. In such colleges, by virtue of better qualified teachers, BSc degree students get benefitted. Many of these colleges have been granted autonomy meaning they can administer their own syllabuses in addition to their own examinations. Regular appointments based on merit take place in such institutions. Therefore, the students receive good BSc degrees.

However, thousands of degree colleges are under State Govts. affiliated to State Universities. The colleges are financially supported by the State Govts. Salaries of faculty come from the State Govts. Most of the colleges established are aided ones. Local leaders joined to establish the colleges largely by money donated by philanthropists. Most of the college

teachers do not hold a PhD. Some of them do go to the nearby University centres to work on part time basis and acquire a PhD. In the years before 1980, smaller number of students were going to colleges. Today, the scene has changed. Number of degree colleges have increased. As of 2017 UGC data, there were about 239 lakh students in India went for higher education after passing PU. Among them, about 49 lakh students got enrolled for three years BSc degrees. Majority of them opted for three subjects among the basic sciences, physics, chemistry, mathematics, statistics, botany, zoology and biology. Approximately, 16%–20% of students passing PU Science go to three years degree courses in science in different States.

UGC gives broad guidelines for the contents of a degree. University associated with the college frames syllabuses under the Undergraduate Board of Studies in each subject. University teachers do not participate in teaching BSc classes. Among the colleges which are older and those which have made a name are still considered good enough to study BSc.

Since 1991 a huge change has occurred in Indian Economy. Country has been moving towards market economy. Opening of economy means less reservation in private sectors. Financial assistances to the higher education have not increased proportionate to increase in enrolment. Strict reservation

policy is imposed mainly in Education sectors. Science degree colleges still remain largely in the State Govt. sector. Appointments to the College teacher's posts decreased because the State Govt. could not afford UGC (Central) salaries. It is a great wonder in India that Colleges have survived and still running imparting science education to whatever level of competence. System of reservation for admission also became mandatory as per the rule. There are two kinds of seats: Free seat and paid seats. Out of the money collected, college appoints part time lectures/contract teachers/guest lectures. The govt. subsidises the teaching cost by providing about Rs 15,000 per month for 10 months only to the extent of teaching load of free seat students. Instead of salary for a month, per hour lecture basis is also followed. In other words, paid students are subsidising education for free seat students. The net effect is lower quality teachers in the degree colleges. In a helpless and hopeless situation of not able to stabilise the college with competent lecturers, common citizen should be grateful to these colleges for, they provide as good a degree as possible.

The MHRD, Government India has announced a new education policy for India in July 2020. Undergraduate degree after completing 12th class is going to be four years duration instead of three years. This is the most important part of the new education

policy 2020 which will be implemented from 2022. We will discuss this aspect in the last chapter of this report.

UGC Refresher Courses for College Teachers

University Grants Commission opened several Academic Staff Colleges in early 1980s across the country to train college teachers in basic sciences. They are situated in the University Campuses. UGC started refresher courses over fifty years ago. The Academic staff colleges have lecture halls with power point presentation facilities. Lectures are delivered by University/ IITs/ IISERS/NITs faculty members and many a times by PG college teachers. They are called resource persons (RPs). Generally, a lecture by an RP is expected to clear doubts of college teachers on a particular topic. RPs are supposed to be knowledgeable by virtue of their research experience. In practice, however, the lecture is around on what the RP knows in his chosen subject and not necessarily connected with the subjects the college teachers want to learn. It is not common for the teachers undergoing training to demand what they want to learn. Participants are rarely consulted by the course coordinators. The UGC refresher course coordinator fixes the lectures based on whom he can get hold of rather than choose who can enrich the teacher's knowledge. By

and large, professors give lecture on what they know and not on what the trainees/teachers need. What a college teacher does not know and what he needs to know is rarely addressed during the UGC refresher courses for BSc degree college teachers.

The UGC refresher courses are based on the assumption that the MSc degree holders are qualified to teach BSc class. They possess adequate knowledge because they are already teaching. Additional knowledge is to be imparted to the teachers by the refresher courses. There is no system to confirm the assumption that the MSc graduates indeed have enough knowledge. Since they all know BSc level subjects, there is no need to give lectures on the topics they teach or topics in the syllabus – this is what an RP assumes. No RP ever evaluates how much of what he taught is assimilated. All he wants is the lecture is a grand presentation of his knowledge and make it more impressive via a power point presentation. Recently they have introduced tests but by and large it is to fulfil the requirements of UGC grants than evaluate what they have gained from the lectures. While there is an appreciation of the lectures by the teachers who attend, learning component to take home to teach on what they need to know is very low.

A more serious point is that generally in three weeks of 18 working days, 108-hour lectures are delivered without

any laboratory component in the UGC refresher courses in physics, chemistry and biology. While the idea of enriching the teachers was conceived well, not including laboratory component and experiments in the training program in the UGC courses seems to defeat the objective of enabling the teachers to comprehend the concepts with greater insight.

There is therefore an urgent need to design and develop training program for the college teachers which is rigorous and include the hands-on experiments which have one-to-one correspondence with what they need to teach back in their respective institutions. Design and development of experiments to the degree level is an extension of what we have done for PU teachers in physics, chemistry and biology. Training mathematics teachers may be relatively easier with the availability of competent teachers at IISc.

A New Approach of Learning Science to Teach Science

Science as we understand today has advanced by systematic observation and experimentation. The best way to learn science is by doing experiments. Already, at two levels of learning, namely high school and PU colleges, learning science by doing experiments indeed has worked

to enrich knowledge in real and measurable terms. The new method has yielded results in terms of students getting desired level of knowledge as shown in chapter 5. Most of the subjects covered in a science text book or prescribed syllabus can be converted into corresponding relevant experiments because scientific knowledge has originated from experiments. Even the theory that was proposed by Maxwell on the speed of electromagnetic radiation had to be verified by experiments. Einstein's theory of relativity had to be verified by showing light indeed bends with gravitational force. This is how the idea of a laboratory to learn science came up around the world. However, over a period of time in India, several factors such as lack of facilities, difficulty of handling a large number of students, inability of teachers to perform experiments other than a few prescribed ones in the syllabus, lack of competence to design new experiments to demonstrate a theory have contributed to lower the level of learning science. Investment in education in general and science education in particular via instruments at each level is low. The goal of students doing experiments to learn science they read in the class rooms is a distant dream. At least the teachers can be trained to learn science by doing the experiments. They can then impart science education to students more effectively. Similarly, the method of solving problems based on the

theory in mathematics is hardly practiced in colleges and universities.

The new approach to train the teachers namely *Learn Science by doing experiments and learn Mathematics by solving problems* is certainly effective. The teacher is well equipped and confident to teach the subject to their students. Eventually, he/she would equip the laboratory experiments in schools, colleges and learning science will become attractive and exciting in India.

With the experience of training over 13,000 teachers at the TDC at all levels, several positive points have emerged in favour of teachers presently teaching science and mathematics in government and government-aided institutions. Teachers generally have good values and constitute a distinct community with motivation to serve the society. Mathematics teachers are more competent than science teachers in general. Teachers are truly interested in acquiring knowledge. They are willing to subject themselves to tests and examination without any kind of resistance and unhappiness. They would like to re-live their student days. Over 95% can be trained to become far better teachers than what they were before training. The fact that they themselves can score over 80% in a test after the training from less than 20% in the pretest speaks well for the teachers and also the training method. They indeed have talents. Most of the

teachers have not had the benefit of learning from competent teachers to the level of their expectation in all the four subjects - physics, chemistry biology and mathematics. Teachers want to learn only from the best. They are averse to sit in the classes when the teacher of the same cadre/level gives lectures. Residential training makes a huge difference compared to day school from 9 am to 5 pm sessions. Teachers are sensitive people as a class and they need to be respected by those who teach them. It is an intellectual pursuit of knowledge. Competence combined with humility on the part of professors who teach the teachers is essential. Therefore, an entirely new approach is needed in India to induce teachers to attain higher levels of knowledge and achieve excellence in teaching at all level. Once they know the syllabus level subjects, they want to know more beyond syllabus. Values such as honesty, punctuality, hard work, motivation can be inculcated/strengthened by those who have imbibed them and practice them. Teachers learn these qualities by seeing the professors who teach them. Professors who taught the teachers at TDC did realise this aspect of human behaviour.

Therefore, there is every reason to extend the methods which has yielded results in the first two levels to BSc teachers' training at TDC.

BSc Teachers' Training at TDC

Having committed to training science and mathematics teachers at all levels, a program to train degree college teacher teaching physics, chemistry, mathematics and biology was taken up in 2015. It had to be aligned with broad contours of UGC guideline otherwise teachers will not attend the programs. A college teacher has to undergo at least two refresher courses to be eligible for a promotion with a minimum B grade. So UGC norms should be kept as it is. Since in the residential training program number of working hours can be increased to 10 to 11 hours per day.

Shortcoming of UGC refresher courses can be rectified. Teach what the BSc teachers do not know and what they must know be implemented. Cover entire 6 semester BSc subjects. Make the training a totally content enrichment one.

We had to go over the subjects they need to teach either by syllabus or concise books written and followed by the students in some of the universities page by page. Convert the theory subjects into experiments. Make the instruments and multiply them for the teachers to do experiments. Bridge the gap between what is learnt in the laboratory and in the class rooms. Objective here is not bringing about a change in the BSc curriculum. This is not practical because TDC, IISc has not

been asked to change UGC guidelines for BSc syllabus. TDC has no access to interact with the Board of Studies of Universities who write the BSc syllabus. TDC has no say how the syllabus is implemented in the Colleges. What TDC can do is to make teachers learn whatever they are supposed to know to teach BSc classes. TDC can innovate on how to make teachers learn what they need in a shorter time. TDC can make teachers how to learn difficult concepts by making them doing experiments and solve problems associated with theory. TDC can show how the trained teachers have been effective to make the college students become more competent. Eventually, UGC and the Universities may find virtue in adopting TDC, IISc model to improve science and mathematics education in India at BSc level. Since there are almost no appointments for college teachers post, there are very few UGC refresher courses for some years now. Officially, guest faculty are not eligible for attending refresher courses. After several months of thinking and discussion, TDC came up with the College teacher's training program. Norms were relaxed to invite contract/guest lecturers. We studied in detail what is the kind of program should be done which help the teachers to provide better knowledge to the students.

BSc Mathematics Teachers' Training

Lecture topics include: 1. Theory of Equations, inequalities, sequence and series. 2. Modern/Abstract Algebra, Groups Rings and Fields. 3. Linear Algebra: Vector spaces, subspaces, linear independence, Basis, dimension; Linear transformations, determinant, rank, row rank and column rank; Linear systems, homogeneous and non-homogeneous systems; Eigenvalues and eigenvectors. 4. Real Analysis: (a) Real number system, elementary theorems, (b) Limits of sequence and properties; (c) Limits, continuity and differentiability (d) Riemann integration 5. Differential equations: (a) Methods of solution of differential equations (b) First order equations (c) Second order linear equations (d) Applications of differential equations 6. Vector calculus (a) Vector differentiation (b) Gradient, divergence, curl (c) Vector integration (d) Green's, Stokes', Gauss' Theorems 7. Numerical Analysis (a) Numerical solution of non-linear equations (b) Interpolation and polynomial approximation (c) Numerical integration and differentiation 8. Differential and Integral Calculus.

Eight to ten professors from IISc and TIFR, ISI Bangalore spend two to three days each in TDC. They come with their research students as tutors to help the BSc teachers solve problems. TDC also has in-house faculty and assistants. A pretest on the BSc level question

are given to get a feel of how good the teachers are. This also makes the teachers assess for themselves what they know and how much they need to know. The same method as in PU and High School is followed for degree teachers' training. First two days are devoted to refreshing PU mathematics. After each lecture, a problem set on the subject just taught in the class is given. We help the teachers solve the problems, make them write properly and submit the assignment. Each day, three lectures and three problem solving sessions in the class room are implemented. After each professor completes one major topic, 1-hour test is given in the morning first hour so that the professor teaching the subject will know how much effective he was in making the teachers learn.

Broadly, the teachers learn mathematics mainly in the problem-solving sessions. They sit in the class room and solve the problems and not in the hostels. Each one's progress is monitored. For numerical analysis computers are given individually loaded with MATLAB software. This step will make them introduce computers in their colleges.

BSc Chemistry Teachers' Training

Chemistry teachers who opted for MSc chemistry with BSc CBZ subjects are too poor in mathematics required to teach chemistry. PCM background

BSc teachers also have to revise their mathematic knowledge. Therefore, for two days, they are taught mathematics, which include real numbers, functions, graphs – linear, sine, cosine, exponential, logarithmic, meaning of equations, solutions, polynomial equations, simultaneous equations, determinants, matrices, differentiation, integration and differential equations. They will solve over 60 problems on these topics.

Another area the teachers need knowledge is how any electronic instrument works. In general chemistry teachers are very poor in measurements and measuring equipment. Fear of handling equipment should be overcome. Therefore, two days are devoted for acquiring basic electronics and measurements. This part of training includes basic electricity and electronics, voltage and current measurements using a digital multi meter, measurement of resistivity, measurement of temperature, digital thermometers, different types of temperature sensors such as thermocouple, Pt₁₀₀, temperature measurements to one and two decimal places, replacement of Beckmann Thermometers for depression of freezing point, elevation of boiling experiments, replacement of mercury barometers by digital pressure meters to measure vapor pressure, vacuum pumps and vacuum measurements, basics of semiconductor devices, LEDs, emission of light from various sources.

The third major innovation TDC has made is introducing computer to plot data from experiments into graphs. Hitherto, graphs are plotted on a Cm graph paper which takes more time and less accurate. Plotting many mathematical functions, they come across, plotting atomic orbitals and find the shape of orbitals and also to use computer to do routine calculations with programming methods will be helpful to the teachers and students. These days computers are available for about Rs 10,000 to 15,000. Students are given computers. But they do not know what to do with it. Inculcating teachers the use of computers is therefore a useful exercise. In many colleges, computer laboratories are established. BSc students can use computers to improve their skill and become competent. In TDC we have introduced laptop to the BSc teachers along with ORIGIN plotting programs. All the experiments they do which need plotting the data are now plotted in the computer. This takes less time than plotting on graph papers. Multiple plots can be drawn in the same graph using computer. More number of experiments can be done in less time. This idea has indeed worked very well in TDC. Above all, teachers cannot fudge the data. It is well known that college students doing an experiment and write the results/reports after several weeks. Most of the time, what they write and submit is actually a copy of the previous students' lab book. College teachers close their eyes, fully knowing that the student has

not got the results they have reported. Presentation of true experiment results can be insisted if they use computers to plot graphs. Slope, intercept and extrapolation are all needed to get the results of experiments they do.

Another innovation we have brought in to learn chemistry is to make the teachers do chemical reactions. One afternoon, they will do over 60 to 70 chemical reactions and write chemical equations. Most teachers have not done most of the reactions. This will fill the gap in inorganic chemistry.

Innovative Experiments to Understand Theory

The topics are divided as per the syllabus prescribed for three years BSc. This needs to be redesigned when four year BSc UG is implemented. They include Electronics and Computers for chemists, General Chemistry, Gas laws and thermodynamics, Colligative Properties and Ionic Equilibria, Electrochemistry, Chemical kinetics and catalysis, Organic Chemistry and Solid-state chemistry. Under each of the topics, 15 to 20 experiments are designed covering most of the concepts they need to know. The instruments had to be designed. Experiments had to be designed.

For example, experiments under general chemistry teachers do include:

black body radiation generation distribution using Ocean optics optical spectrometer, Energy of a photon $E = h\nu = hc/\lambda$ using a digital spectrometer, verification of photoelectric effect and determination of Planck Constant, Hydrogen emission spectra and determination of Rydberg Constant, helium emission, helium energy levels, - not following Bohr's formula, Alkali metal emission and energy levels, Ark spectra of Cu, Zn, Fe and C wavelength associated with the elements, and discovery of elements, flame spectra and emission lines, Moseley's law, Plotting atomic s, p, d and f orbitals, plotting hybrid orbitals, Shapes and sign of the orbitals. These experiments directly related to atomic structure and electronic, electronic configuration and they sound like theory topics. Over 60 chemical reactions are done on one afternoon to understand chemistry of elements as part of inorganic chemistry.

Under gas laws and thermodynamics, teachers do Hg barometric pressure measurement, Boyle's law, Charles Law, Absolute zero, C_p/C_v , thermal expansion of solids and liquids, latent heat of fusion, latent heat of vaporisation, Clausius- Clapeyron equation verification, verification of second law of thermodynamics. It can be verified from the normal BSc course experiments that not even one experiment under this topic a student does in any Degree college.

Similarly, the experiments on other

topics are given in the Appendix C. Teachers do all these experiments during the training program. Instruments may be available but to make use of them to do good experiments involves a lot of research in chemical education. That has been done.

On each day two lectures for about 2 h 30 min are given by an IISc professor. Then they will be doing experiments. Lectures are planned to cover important and difficult subjects. Many a times, experiments are sufficient to cover the topics in addition to learning how to perform experiment.

X-ray diffraction in BSc as well as MSc levels has remained at $2d\sin\theta = n\lambda$. Both Physics and Chemistry BSc students need to study this. Lattice parameter, atomic and ionic radii, packing fraction, FCC, BCC, SC and number of atoms in a unit cell, intensity of diffraction lines are all derived from an X-ray diffraction pattern. TDC has an X-ray diffractometer and it is used for research also. This part of the subject in the syllabus is not taught. We teach the teachers and it is a big step in learning solids and structure of solids.

Every day one assignment covering the day's topic is given out and they will submit by next day morning. They are corrected, discussed by the professor in the class room and returned. In general, it is an intense Chemistry course.

BSc Physics Teachers' Training

Lectures are arranged on topics covering entire 6 semesters for BSc. Electronics, Heat and Thermodynamics; Light and theory of Optics, Modern Physics, Atomic and Molecular Physics, Nuclear Physics, Electricity and Magnetism, Mechanics and Preliminary Solid-state Physics; and Mathematical Physics and Quantum Mechanics. There are the main topics prescribed for BSc students in six semesters. Experiments are designed under each topic covering about 85% of these theory subjects. Many a times, lectures are not necessary if the teachers did experiments to learn theory. Substantial number of subjects is covered by the instructors during the experiments' sessions introducing underlying concepts. In certain subjects such as heat and thermodynamics, atomic and molecular structure, X-ray diffraction to find structure of solids, spectroscopy have almost no experiments at the BSc level. About 70% of the experiments designed and implemented are new to the BSc teachers. Huge disconnect between the theory they read and experiments they perform has been bridged by innovative experiments designed in TDC. The training also emphasises problem solving, one assignment of about 15 problems each day. Only one afternoon, teachers are given holiday in the entire 21 days program. The fact is the teachers are truly interested to learn because TDC provides a unique opportunity to learn what they need to

teach. Skill to do experiments by the teacher is enormously increased in this training. Experiments performed by the teachers in 21 days is briefly described subject-wise in the Appendix C. It will give an idea of novel experiments designed to understand theory subjects. It is possible for the teachers to perform most of the experiments by keeping theory lectures to a minimum of two per day and giving time to perform experiments to the teach.

BSc Biology Teachers' Training

BSc Physics, Chemistry, Physics and Biology teachers' training is held simultaneously. The program for biology is consisting of 80 h lectures and 100 h laboratory.

Lectures on microbial diversity, fundamentals of immunology, immunochemical techniques plant physiology, plant biotechnology, plant reproduction, the basic of Mendelian genetics, *Drosophila* genetics, human genetics, population genetics, genome and functional genomics, molecular biology the topic like DNA repair mechanisms, reproductive biology, animal physiology, hormones, cancer biology, general molecular biology, genetic engineering, biotechnology, signal transduction, structural biology, bioinformatics, protein structure and function, basic of statics, enzymology, enzyme regulation, enzyme kinetics

are given by the professors of IISc, biology department. Almost the full syllabus is covered. On each day, corresponding experiments are done by the teachers. In the laboratory each day 3-5 experiments are carried out. Experiments carried out by the teachers are given below. Appendix C gives short write on experiments done by the teachers during the training program. Some of the BSc experiments in all the three subjects necessarily repeat from PU science studies. This is true during the first two semesters of BSc in science and also BE/BTech /BS courses where they need to study basic science again. Only in BSc 3, 4 5 and 6 semesters more of new subjects are introduced. In TDC, even though the same apparatus may be used, experiments are expanded to derive more results on the same topic. Three weeks available is fully utilised for the training and indeed, an excellent course is possible to organise. What is not covered in the theory classes are covered in the laboratory. Teachers enjoy the laboratory part because they have not done most of the experiments in their MSc classes.

Experiences from BSc teachers' Performance

A system of evaluation of teachers is evolved via tests. In the following bar diagrams, we have given performances of teachers before and after the training in P, C, M and B subjects for two years 2018

DEGREE COLLEGE TEACHERS TRAINING PROGRAM IN PHYSICS (22-11-2018 to 12-12-2018)

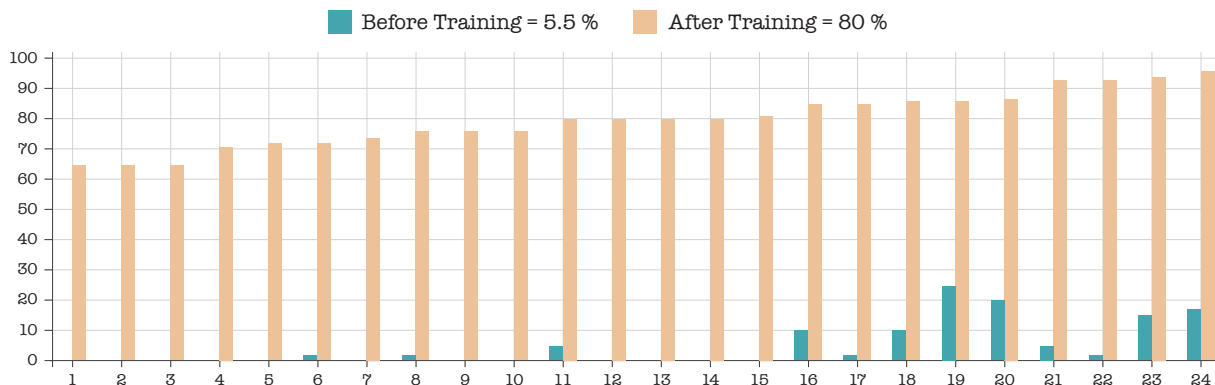

DEGREE COLLEGE TEACHERS TRAINING PROGRAM IN MATHEMATICS (22-11-2018 to 12-12-2018)

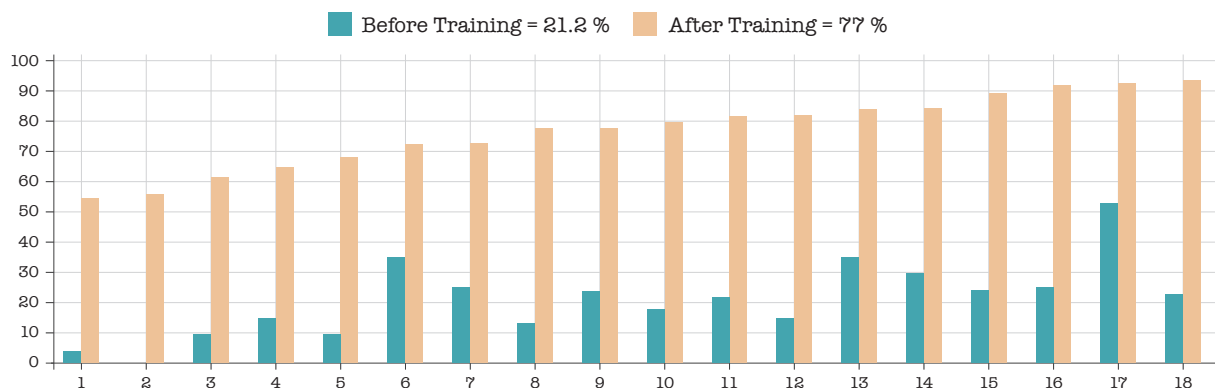

DEGREE COLLEGE TEACHERS TRAINING PROGRAM IN CHEMISTRY (22-11-2018 to 12-12-2018)

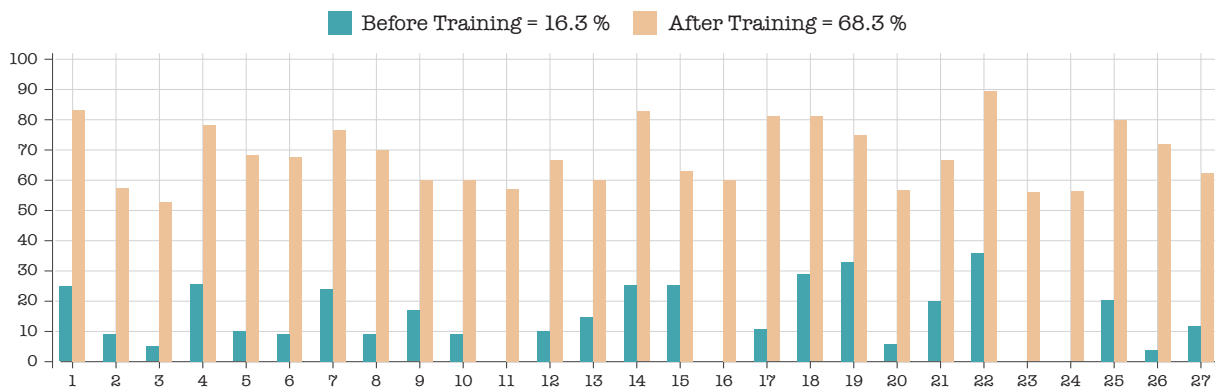

DEGREE COLLEGE TEACHERS TRAINING PROGRAM IN BIOLOGY (22-11-2018 to 12-12-2018)

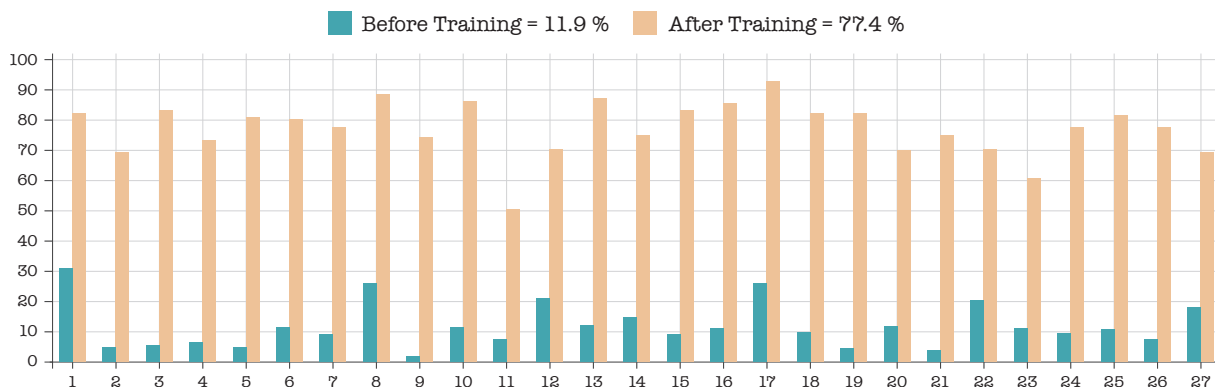

DEGREE COLLEGE TEACHERS TRAINING PROGRAM IN PHYSICS (22-11-2019 to 12-12-2019)

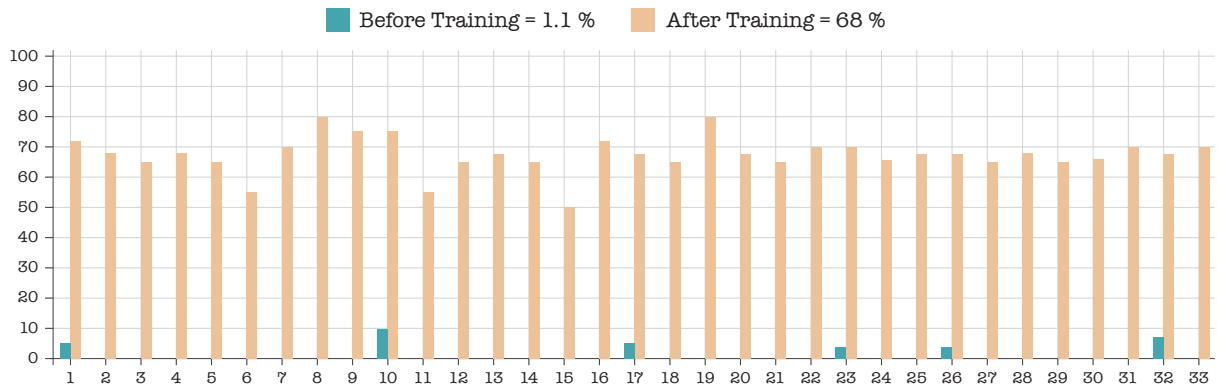

DEGREE COLLEGE TEACHERS TRAINING PROGRAM IN CHEMISTRY (22-11-2019 to 12-12-2019)

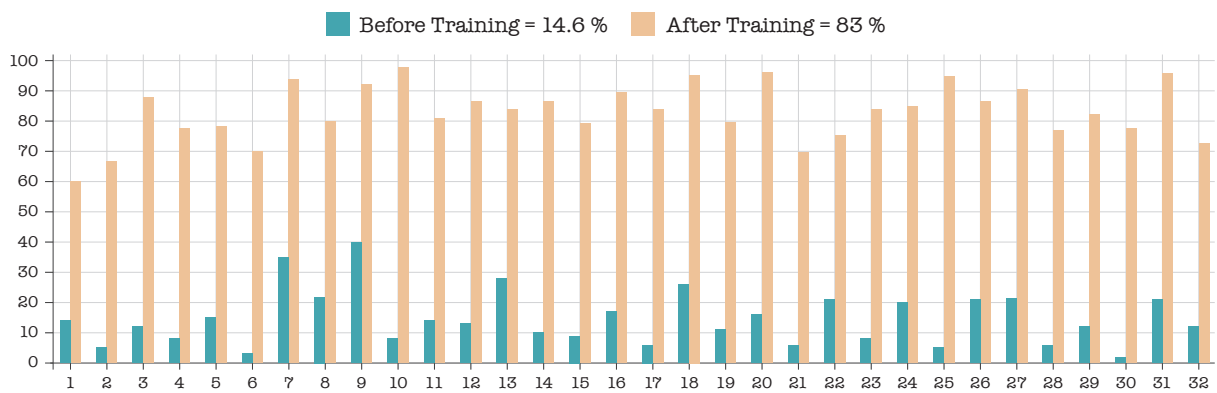

DEGREE COLLEGE TEACHERS TRAINING PROGRAM IN MATHEMATICS (22-11-2019 to 12-12-2019)

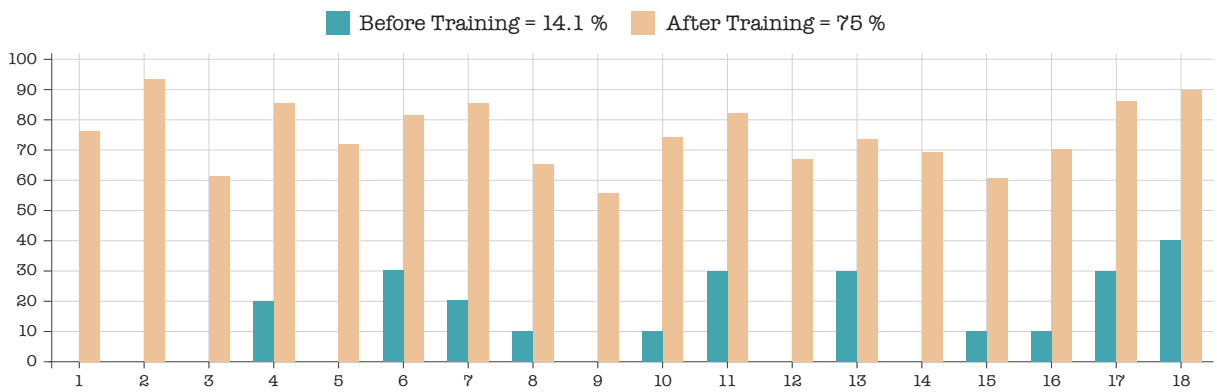

DEGREE COLLEGE TEACHERS TRAINING PROGRAM IN BIOLOGY/ LIFE SCIENCE (22-11-2019 to 12-12-2019)

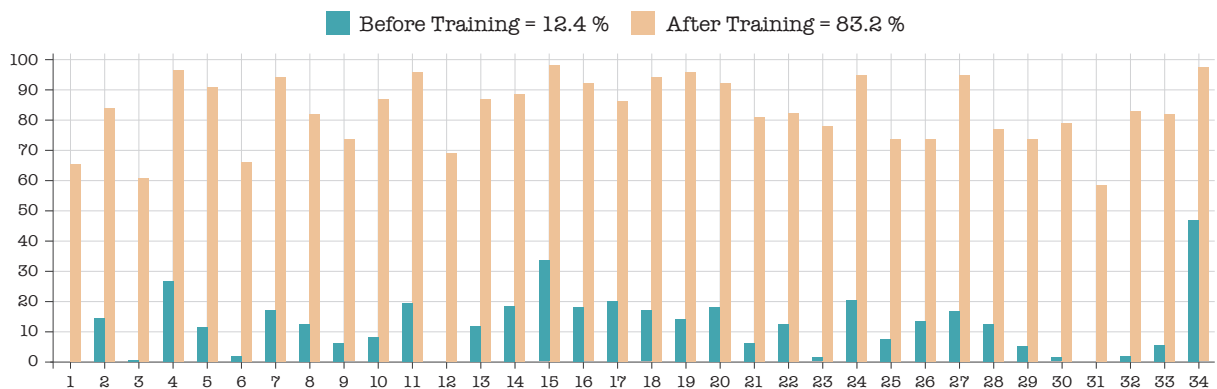

and 2019. All the teachers have taken the tests. No class marks are added. Paper is for 100 marks.

Huge improvement is obvious from the two years' experience. Talent among the teachers can be brought out consistently. Experiences of high school and PU college teachers is repeated in the performance of BSc college teachers.

Development of experiments is also a major achievement for TDC. Even more satisfying is that the theory subjects can be learnt through experiments. That science can be learnt more easily is again proved at the third level of science education.

If these experiments are introduced to the colleges there will be a huge improvement in the level of learning at BSc level. We have provided a model training program for BSc teachers. In the years to come, we can improve it further. It is for the first time such a major and new program is implemented.

Consistency of the training can be gauged from the performance of teachers for two years. This is a big step in the BSc teachers' training against UGC teachers' refresher courses. This is a giant experimental program conceived, developed and implemented at TDC.

Organisation of BSc Teachers' Training

For BSc, we invite teachers to apply for the program through an advertisement in IISc Website detailing the content of the program. Teachers from all over India do apply. As of now we are able to conduct only one program a year. Only in May–June and November–December, teachers are free to attend the courses. Principals of colleges do not want to send the teachers during the semester period. We have extended this program to the guest lecturers so that those teaching BSc are benefitted.

Unlike the UGC programs, we in TDC do not have enough funds to provide TA/DA to the participants. Yet teachers are coming paying for their travel. Local hospitality is fully taken care by the TDC.

The same method of training high school and PU teachers is essentially adopted for BSc teachers because, the syllabus is reasonably well defined. Unlike the high school and PU levels, there are no standard textbooks for BSc students. This is primarily because UGC broadly describes subjects to be covered and each university administers the degree program. It is de-centralised. This is the reason why there is large variability of quality of graduates coming out from universities. Some of the colleges, generally established ones try make the program to attract students. There is only a narrow window of days that the BSc teachers can come for training –

that is 20th November to 15th December. Therefore, all the BSc programs have to be conducted in this narrow period in a year.

How to implement laboratory practices in the colleges?

We gave a full set of experiments to two colleges in Karnataka. 1. Basaveshwar College Bagalkote and Bhandarkar College in Udupi District. Good number of teachers were trained from these two colleges. These two are representative BSc degree colleges of some standing and the college was receptive to our idea of improving the standards.

There are specific problems to implement these experiments in the BSc courses. The University has prescribed laboratory experiments for the 6 semesters and one cannot change the experiments prescribed by the University. It is against the rules. So, introducing these new experiments to the students is not permissible. However autonomous colleges can adopt new experiments and attract students based on quality education they can provide.

What we tried was to make the teachers do the experiments in the class room as demonstrations. We spent considerable amount of time in the colleges to show how in 45 min class we can do an experiment on that subject by the teachers. This is doable and reasonably accepted by the teachers.

The second method we suggested was to utilise extra time available during the regular laboratory time allotted for their course program. Most of the experiments prescribed in the course can be done in half the time and remaining time can be utilised to demonstrate the new experiments. This is also feasible. Now, if the teachers are enthusiastic to make the students interested, students can perform these experiments in extra time.

The third alternative is to make the colleges autonomous. There are colleges which are autonomous. We need to try and see how the autonomous colleges receive the idea of attracting students to learn more via new experiments. This can be a selling point for the colleges to get more and interested students.

Another possibility is to get money under Skill Development program of Govt. of India. What is certainly possible is to utilise 25 to 30 days' vacation for imparting experimental skills to the students. The purpose of skill development as well as better quality education both will be served.

MSc Teachers' Training Program

University Grants Commission is a statutory body of Government of India created by an Act of Parliament in 1956. The Commission in consultation with the universities concerned, takes all such steps for the promotion and coordination of university education and for the determination and maintenance of standards of teaching, examination and research.

The UGC serves as a vital link between the Union and State Governments and the institutions of higher learning. In addition to its role of giving grants to universities and colleges, the UGC also advises Central and State Governments on the measures necessary for the improvement of university education. It also frames regulations such as those on the minimum standards of instruction and qualifications of teachers. The UGC has over the years,

evolved and implemented a wide variety of programs for realisation of the goals of higher education. Among many programs, UGC has instituted "UGC Refresher Courses" in 1986 by creating academic staff colleges.

For over 40 years, the UGC has dispensed with specialisations in MSc degree in any major discipline. UGC norm is one MSc degree with all the branches put together coming under one discipline. For example, there is only one MSc chemistry degree as per the UGC guidelines which include all the branches of chemistry. The same is true for other major subjects – one Physics MSc, one Mathematics MSc. For first three semesters, subjects are common for all the students of chemistry and in the fourth semester one or two papers or courses they credit as special subjects in addition

to completing core subjects and a small project. Teachers are expected to teach MSc chemistry core subjects irrespective of his or her specialisation. Therefore, MSc teachers' training program covering major part of common or compulsory subjects is ideal for a refresher course.

Universities are the centres of higher learning. Faculty members are engaged in research in addition to teaching PG students. But, more often than not the MSc graduates coming out of Universities in basic science subjects seem to perform rather poorly as can be judged by their performances in NET and State Eligibility Test (SET) for admission to research and lecturer positions. Less than 1% of number of students who appear for tests pass NET to qualify for research and less than 5% qualify to become lecturers. Over 50% of MSc degree holders do not appear for NET. NET and SET are indicators of competence of students coming out of the Universities. Obviously, the competence acquired by our MSc graduates is low. One does not hear about how to improve this either from the universities or UGC. Because of this, most MSc graduates from the Universities and PG centres do not get admission for higher studies abroad for MS and PhD. Even to study by payment of full fees, minimum eligibility is essential that is not crossed. This is the genesis of entrance examinations or qualifying tests for any job or higher studies for our MSc degree holders.

Something needs to be done to improve this dismally low quality of over 90% of MSc degree holding post graduates produced by India. Clearly, the problem is at the university level.

General perception and to a large extent the facts are: In the PG department of most of the State Universities, about 15% of the faculty are considered competent. This essentially means only 1 in 5 to 6 faculty members is able to provide required knowledge and inspire the students. Others do teach and cover the syllabus but knowledge imparted is not likely to the level desired. This is to be compared with IIT or IISER science departments. At least 85% to 90% are competent. Obviously, quantum of knowledge acquired by the students falls short to about 20% compared to a well-trained MSc graduate from IITs, IISERs and many of the Central Universities. The most important factor for this dismal competence level is the lower amount of work a majority of the university teacher do in comparison to IISc, IISCRs, IITs and some of the Central Universities for the same salary they earn. I was invited to give a series of lectures in Karnatak University in 2002. Upon reaching the department at 9 am, not a single faculty member had come. The head of the department came at about 11 am. Most faculty were in at about 11 am. Most of the faculty left the department to homes as soon as the special lecture was over at 5 pm. Some research students are

found doing work which was a good sign. Things have not changed much in 2019. Experience of a recent visit in 2019 to Mysore University was not different.

If the MSc degree holders coming out from universities possess good knowledge who eventually become college and high school teachers, there would be no need for training PU and high school teachers. This is not the case always. The main reason for the low quality lies in the way MSc students are trained at the Universities and PG centres. The other reasons are: (a) Dependence only on class room lectures is inadequate for understanding the subject in depth. They need to master certain minimum number of books. (b) Inability of students to cope with the theory content imparted through less competent teachers. (c) Limited exposure of teachers to only selected areas of the subject. (d) Superficial coverage of subjects in the syllabus in the class rooms. (e) Lack of novelty in the experiments prescribed in the laboratory courses because experiments that are prescribed and done presently in most universities are at least fifty years old. (f) Too little – too small number of repetitive experiments in the laboratories for the time they spend. (g) Low experimental skills imparted to students due to inadequate skill among the faculty. (h) Not able to teach the syllabus such that the students are able to solve

problems. (g) Disconnect between the laboratory experiments and the theory taught in the classroom. (h) Near absence of culture of assignment writing/solving, submission, correction and returning the corrected answers in time in the universities unlike in IISERs and IITs. (i) Lack of adequate and standard experimental facilities in the institutions. (j) Not able to appoint competent faculty for whatever reasons and excessive inbreeding of faculty. (k) Carrying on with the guest faculty who are not fully qualified to teach. (l) Neglect of higher education by both State and Central government and finally UGC to maintain and monitor quality. (m) Inadequate funds and not efficient/prudent use of available funds for basic teaching and laboratory expenses.

Honesty among the teachers plays an important part to enhance quality of learning. One incidence may give an idea how bad the practice of practical examination is in many of the universities. I was invited to conduct practical examination for MSc chemistry by Gulbarga University. Experiments were given to the students – three experiments (one long and two short) for the whole day. All the students kept their laboratory note books (manuals) on the examiner's table. The laboratory manual they produced were neat and looked very good. The contents, however, were found to be copies of three or four old students' manuals including the data presented. This

scenario is no different in other Indian universities. Everyone knows about such practices. The teachers just look the other way and give completion certificates, may be because they are also the products of the same system.

Examination reports came in. Entire results of all the students were copy of the experiments they had written in lab manuals which they had submitted. All the students had copied what was written in the manuals. Co-examiner, the head of the department of chemistry was shown this to his great embarrassment. All the students pass with high marks! Obviously, almost all are made incompetent one shot by the dishonesty of the teachers. So, there is a necessity to change the process of learning itself. Honest reporting methods have to be introduced to the teachers attending training programs so that they can practice in their institutions. Truth is harsh.

Research and Development on Science Education

Except Homi Babha Centre for Science Education, there is no other recognised centre or institute to develop Science Education and Technology in India. None of the IITs and Central Universities has research and development programs for science education. Faculty members in meetings decide what is good and

implement them. There are large number of Education institutions in India which give BEd, MEd and PhD degrees. These institutions largely worry about the methodology of teaching, pedagogy and epistemology and do not worry about content enrichment of a teacher. There is no content learning in BEd and MEd courses. The programs in these institutions are to be considered good in all respects provided the teacher has requisite knowledge in a subject he/she needs to teach. Once a person has a qualifying degree to teach in colleges or universities, it is assumed that he has the full knowledge to the extent the teaching demands. Contradiction here is: "How does the method of teaching helps if the teacher does not have required knowledge to teach?" The education degrees BEd and MEd do not take care of special requirements of science teaching. It is curious to find that none of the teachers from IITs, IISc, NITs, Central Universities teaching science and humanities needs BEd and MEd degrees. Clearly, BEd and MEd seem to be redundant. This is the general opinion of people governing NCERT. Yet no change occurs on the ground to enhance content enrichment in BEd and MEd. At last, new Education policy 2020 GoI has scrapped BEd.

To build experimental facilities and to bring up the training to the present level of understanding science subjects, research and development in "Science

Education" is essential. Advanced research institutes do excellent research of international standards but they do not address instruments and experiments requirements for School/ College/University science education. UGC and DST do provide funds for MSc laboratories. Since most of the instruments are to be imported, they can have just one instrument for 60 MSc students which is grossly inadequate. Experiments based on one to two instruments cannot become curriculum experiments. The instruments needed to learn science at MSc level are not available at affordable cost for routine teaching purposes.

UGC Refresher Courses for University Teachers

University Grants Commission has established academic staff colleges to train University teachers across the country since 40 years to improve quality of post graduates in India. Academic staff colleges carry out the training. Academic staff colleges have a building, facilities to conduct courses namely lecture halls with projectors for power point presentation, good class rooms for both lectures and discussion. There are no laboratories for science courses in these staff colleges. Faculty member of a university, generally a professor or head of the department in any discipline proposes a 21-day program to UGC. The Refresher

Course should be of 108 contact hours scheduled for 3 weeks; 21 days minus three Sundays leaving with 18 working days. Resource Persons (RP) come from the same university or from Central Institutions on invitation for one to two days. The lectures should help the teachers learn what they do not know and what they need to know to teach MSc students. Whatever they learn in the refresher courses should help them give better lectures to the students. Then the RP is supposed to go beyond to increase knowledge of the teachers. But, most RPs lecture on what they know and not what the MSc teachers need to know. Two such courses a lecturer or an assistant professor should complete to qualify for a promotion. In practice, rigorous content enrichment of the MSc teachers does not take place in most of science refresher courses to improve the quality of MSc graduates. Recent modification is the RP should leave some questions for the coordinator to include for a test at the end. Coordinator has not attended the lectures. There are no tutors for the courses. Participants listen to wonderful lectures and appreciate but that is not sufficient to answer questions covered in the Power Point presentation. Therefore, it is unlikely that the questions even if answered, there is a possibility of fair evaluation of answers.

One of the main drawbacks of UGC refresher courses in science subjects is the absence of laboratory component

in training university teachers. It is assumed that the teachers would have done all the experiments prescribed for MSc and that is more than sufficient. It is a fact that experiments only cover far less than 10% of the theory they study at present. Most of the experiments are repetition of BSc experiments. There is no connection or relation between the experiments they do and get examined and the theory they study and pass in theory papers. The two parts are totally separated. The experiments are 40 to 50 years old. Innovative experiments need to be set up to make the students competent. Attempts to develop new experiments on a theoretical concept require competence among the faculty. Learning theory by doing experiments needs to be explored fully so that our MSc graduates become competent and develop an inclination to pursue research. At least the skill to do experiments correctly, promptly and present the results honestly will go a long way towards improving the quality of science education in India. The teacher must be trained to be competent and honest in handling the experiments. With well trained teachers in the university system, MSc graduates can be made competent and better positioned for teaching as well as to work in R&D laboratories or industries. Therefore, there is an urgent need to develop laboratory courses in the UGC Refresher Courses to understand the theory subjects which the teachers teach in the class rooms.

In high school, experiments are basically demonstrations in the class room. Some of these demonstrations become experiments in PU to be performed by the students in the laboratory. Most of the subjects studied in PU repeats in BSc for first two semesters and so also the experiments. Number of experiments and degree of difficulty to study next 6 semester increases in a BSc course. Substantial shift to new subjects occurs in MSc first three semesters. Study of one or two special subjects and dissertation in fourth semester is followed in most universities. It is unrealistic to expect research in MSc level across Indian universities. Instead good training through courses will add to their knowledge to pass NET and CET. Most of the experiments described in chapter 7 in this book on BSc chemistry experiments are indeed come from the theory subjects they need to study. Most of the BSc experiments described in chapter 7 have not been available in the degree colleges. The teachers have not done those experiments in MSc also. In most universities, even in MSc general laboratories, except electrochemistry and organic chemistry, experiments on other subjects are not done because experimental facilities are not available. More correctly, instruments are not made in India to be made available at an affordable cost. This complicates further the design of a useful training program for MSc teachers.

A few instruments are absolutely essential at MSc level training. For example, in chemistry powder X-ray diffractometer, UV-visible spectrometer, infrared spectrometer, light emission optical spectrometer, NMR spectrometer, gas chromatograph–mass spectrometer (GC/MS), HPLC, Electrochemical work station for cyclic voltammetry, Similarly, computers are essential.

MSc Teachers' Training At TDC

TDC has developed science teachers' training program up to BSc level with more than 85% of theory that can be learnt by doing experiments. The strategy for MSc has been, at least 70% of the core subjects should be learnt by doing experiments. Innovate learning by employing computers is the step taken in TDC. Bring in computers to learn quantum mechanics both in chemistry and physics and bioinformatics in Biology is an innovation made in TDC. Other initiatives are: Search instruments around the world which can be affordable by a university specifically to teach MSc level subjects, extend the instrument capabilities used for BSc to be useful for MSc, obtain data on spectroscopy and many other subjects and make the teachers learn how to analyse them. The same strategy works for physics and biology as well. Accordingly, TDC has developed acceptable level of

MSc teachers' training to cover core subjects including a lot of relevant experiments. Research assistants help teachers do experiments and results are checked on each experiment. In addition, the professors spend full time in the Centre for clarifying the doubts and questions. Physics, chemistry and biology teachers submit a report of the work done during the 21 days program in about 40 to 50 pages. The report includes near research level experiments/calculations done by the participants. They are examined and grades are decided. Abstract of the report teachers submitted for chemistry is presented to give an idea what the teachers accomplish in 21 days. Physics and biology teachers also do similar work. Mathematics teachers are given series of examinations in each subject and also pre and post-tests. Training mathematics teachers is relatively easier. Basically, the mathematics teachers have to be reasonably good in their subjects because of the nature of the subject – Mathematics.

MSc Chemistry Teachers' Training Program at TDC

A. Basic mathematics for chemists

Chemistry teachers are short of mathematics knowledge to routinely handle physical chemistry. Mathematics knowledge required to understand quantum mechanics is not included

in BSc mathematics syllabus. MSc graduates with CBZ background are too poor in mathematics and mathematical concepts. They are not used to solve problems. Teachers are not familiar with special functions such as Legendre, Laguerre and Hermite polynomials, Eigenfunctions and Eigenvalues, Fourier transform, solutions of Schrodinger equation in quantum mechanics, solutions of equations by numerical methods by writing a program in a PC, plotting various functions such as sine, cosine, radial plots, circle, parabola, anharmonicity, shapes – cube, cuboid, ellipsoid, triangular, tetrahedral, octahedral cubic geometries to understand crystal geometries and packing of atoms and ions in solids. Similarly, plotting the distribution functions in statistical mechanics too needs knowing extra mathematics. Therefore, teachers are given three days of mathematics and computer training. Mathematics for chemists include: 1. Number system, 2. Functions and relations, 3. Polynomials and identities. 4. Differentiation, Integration, 5. System of equations, polynomials and special functions, 6. Matrix and determinants and Eigen values and Eigen vectors, Fourier series, functions and transform. They are taught ORIGIN software for plotting functions as well as data from experiments. In IITs and IISERs the students take mathematics courses which cover this part and hence the MSc training in these institutions is superior.

B. Basic Electronics for Chemists

The second innovation we have brought in to the MSc teachers' training is to provide essential knowledge of electronics. They should be comfortable to handle routine measurements of voltage, current, resistance, using digital multi-meter, measurement on conductivity, resistivity, temperature from liquid Helium (4K) to 1000K, temperature measurement to second decimal place in a narrow range of temperature 300K to 400K, measurement of temperature using K type thermocouple, calibration of Chromel–Alumel thermocouple, Pt₁₀₀ resistance thermometer, silicon diode thermometer for low temperature, accurate measurement resistivity of metals, R vs T for metals and semiconductors, diode and light emitting diodes, photo diodes, light intensity measurements are some of the key experiments a chemistry teacher must know. In two to three days, the teachers do these 15 experiments in the laboratory and get equipped with essential electronics.

C. Electronic structure of atom, molecules – General Chemistry

Lectures consist of idea of quantum, Bohr atom, Bohr – Sommerfeld model, evolution of four quantum numbers, de Broglie principle, Schrodinger equation originating from wave equation, hydrogen atom problem, solutions of Schrodinger equation

leading to radial and angular part of wave functions, radial distribution of electrons, electronic transitions in atomic emission – allowed and non-allowed, Aufbau Principle, electronic configuration of atoms, ions are covered in 4 lectures followed by the following experiments.

Experiments:

These are basic general chemistry experiments which form essential part of the MSc first semester. Doing experiments is sufficient to learn the subjects. The experiments to be performed by the MSc teachers under this topic are: (a) Black body radiation – for a hot body employing Ocean Optics spectrometer; (b) Lambda maximum of solar spectrum, Ozone cutoff wavelength; (c) Plotting Plank's black body radiation distributions – Wein's displacement law; (d) Energy of a photon and electromagnetic spectrum with a constant deviation spectrometer reading wavelength directly; (e) Determination of Plank's constant - Photoelectric effect; (f) Hydrogen emission spectra – energy levels of hydrogen and determination of Rydberg constant; (g) Helium emission spectra and singlet and triplet electron states of helium; Ortho para hydrogen and ortho para helium, Metastable states; (h) Alkali metals emission and energy levels, resonance transition, allowed and non-allowed transitions; (i) Arc spectrum of Zn, Carbon, Al, Cu and Fe and spectral transitions; (j)

Flame spectroscopy – Li, Na, K, Ca, Sr, Ba - actual transitions giving specific emission lines leading to colours, interpret emission lines via transitions; (k) Moseley's law –plotting square root of $K\alpha$ radiation vs atomic number Z ; (l) Plotting of atomic orbitals and understand shapes of 1s, 2s, 2p, 3s, 3p, 3d orbitals; (m) Plotting hybrid orbitals and shapes of sp , sp^2 , sp^3 , dsp^2 and d^2sp^3 orbitals and distinction between orbital wave functions and their corresponding square functions to get radial and angular part of electron densities distribution. These 12 to 15 experiments are the basis for electronic structure of atoms, ground state configuration based on hydrogenic orbitals which is part of the MSc syllabus. This part covered in three days. A constant deviation spectrometer to measure wavelength of emission lines, optical emission spectrometer made by Ocean Optics and Origin programs in a PC are adequate to learn this basic chemistry which are implemented in TDC. Radial and angular distribution functions from the solutions of Schrodinger equation plotted employing Origin program shown here demonstrate nodes, probability density, tunneling, plot of orbital meaning wave functions, radial electron density distribution, maximum electron density and distance of orbitals, angular nodes, hybrid orbitals, penetration of s orbital is more than p and d orbitals are all covered in this exercise. In Figure 1, typical plots of radial distribution functions plotted by the teachers are given.

Figure 1. Radial distribution plots of (a) 1s, (b) 2s and 2p, (c) 3s, 3p and 3d, (d) 4s, 4p, 4d and 4f orbitals and angular plots of (e) p_x , (f) p_y , (g) d_{xy} and (h) d_{z^2} orbitals.

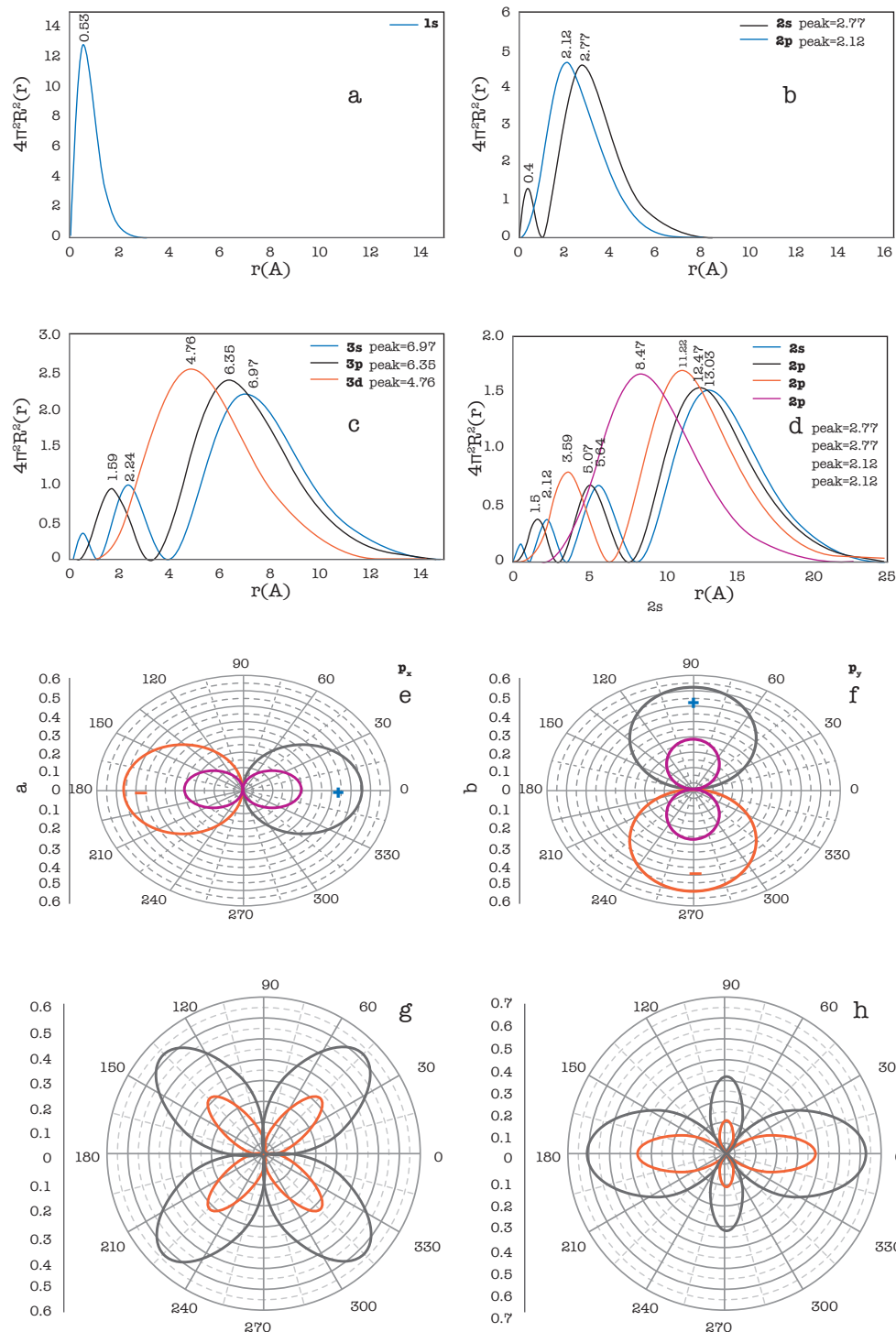

Teachers of chemistry have a problem of deciphering sign of the angular orbitals. Often, the p orbitals one lobe is marked +ve and the other -ve. Sometimes there are no signs in the orbitals. Only after plotting mathematical function $\cos \theta$ vs angle in the radial graph (Fig. 1e and f) they understand $\cos \theta$ has sign in the radial plot giving +ve and -ve lobes. Angular part of 2p wave function is just $\cos \theta$ vs θ (in radial 0 to 2π). Square of the function is the real orbital which predicts electron density distribution. Most teachers with MSc degree would not know what is a radial plots of $\cos \theta$, $\sin \theta$, or their squares vs θ from 0 to 360° . They have never plotted a radial plot of a trigonometric function because that is not taught anywhere in their career. In figure 1e to h, both orbital functions and their squares are plotted. On squaring the function and then plotting, the value of the function is positive and the dumbbell shaped p orbital emerges. This is possible for the teachers to learn only when they plot the function and they get thrilled to see the s, p, d orbitals origin of which they never knew even though they were teaching them.

Teachers also plot a large number of mathematical functions to understand the functional variation of properties. All the statistical distributions are plotted by varying temperature which they need to teach. Other functions include Maxwell distribution of velocity, Fermi Dirac distribution,

Bose distribution, Planck black body distribution and so on.

D. Electronic structure of atoms, molecules and solids by DFT calculations

At this stage after completing about 6 days, DFT calculations are introduced to MSc teachers. Next 14 days teachers do DFT quantum calculations to obtain energies of electrons in atoms, molecules and solids for 4 to 6 hours a day. Other core subjects are covered in the remaining time each day. Quantum mechanics (QM) is a compulsory subject for MSc Chemistry. Teaching QM chemistry courses has remained abstract theory with little connection with what it gives to understand chemistry over the last 50 years in Indian Universities. QM is a method to obtain electron energies in atoms, molecules and solids. John Pople who won Nobel Prize in 1998 developed Gaussian Programs to do quantum calculations. The software has to be purchased like an instrument and its license needs to be renewed every year. The method obtaining electron energies need computers. How to use the program to get electron energies are even today not taught as part of QM lessons to the students. The method was not reachable by most chemistry teachers and hence students. Only those faculty members who were doing research in "Theoretical Chemistry" taught QM to their PhD students. Even today it has

remained unreachable secret to most chemistry students.

Energy levels of electron in hydrogen atom is the only one that is solved exactly by Schrodinger equation in Quantum Mechanics. When one more electron is added in helium, energy levels of electrons in He atom cannot be solved exactly by QM. During the last 40 years, a new method to calculate energies of electrons in atoms, molecules and solids has been introduced by Walter Kohn (who got Nobel Prize along with John Pople) and his associates. The program to calculate electron energies are available free of cost and the programs can be downloaded and installed in a PC. With initiation of how to do calculations in TDC, all the MSc teachers are able to learn how to obtain ground state electron energies of atoms, molecules and solids within one to two days.

Density-functional theory (DFT) is a computational quantum mechanical method used in physics, chemistry and materials science to investigate the electronic structure of many-body systems, in particular atoms, molecules, and crystalline solids. Properties of a many-electron system can be determined by using a functional, i.e. functions of another function, which in this case is the spatially dependent electron density. Hence the name density functional theory. DFT is among the most popular and versatile method available in condensed-matter

physics, computational physics, and computational chemistry. Quantum Espresso is the program used for calculations which is available free of cost. It can be downloaded from heaven!

Basic concept and theory are taught first to MSc teachers. Then they are taught how to do the calculations. It is now like doing experiments with the program available. Each one is provided a PC (Laptop) loaded with Quantum Espresso and the required data on pseudopotentials. A tutor teaches how to do the calculations by projecting the terminal on the power point screen. Initially teachers are given the exercises on Linux commands for creating input files, how to edit a file with vi commands, visualisation of input files and commands to run DFT program. Usually, atomic calculations are easier which requires 1–2 minutes computer time to get the output. In atomic calculations, atoms are fixed in an arbitrary position in a cell of $30 \times 30 \times 30 \text{ \AA}^3$. Self-consistent field (SCF) calculation is carried to minimise the energy. A run command does that. Output of SCF calculation gives total energy and orbital energies of atoms in their ground state. Shape of the orbitals are obtained by HOMO and LUMO calculation by giving the k-band values (essentially number of electrons) of required orbital.

Energies of s and p orbitals in second row elements of periodic table obtained by the teachers from DFT are tabulated

and plotted in the figure 2. For Li and Be, energies of 2s and 1s are available from DFT. The energy difference between 2p and 2s orbitals increase with increasing atomic number. This explains why hybridisation in oxygen is

weak compared to C and N. Occupancy in each orbital becomes obvious from the calculation. The orbital energies obtained by the calculation can be compared with ionisation energy of elements directly.

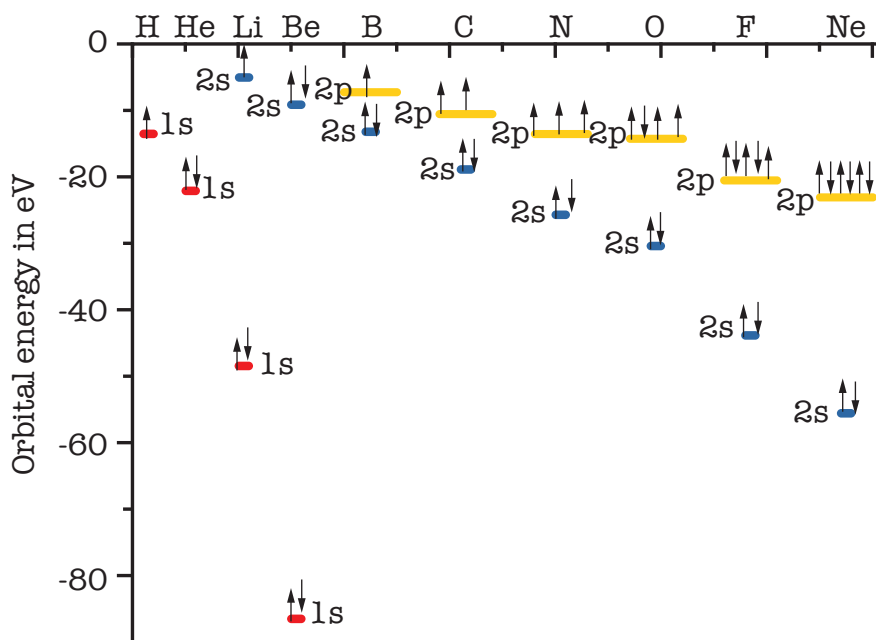
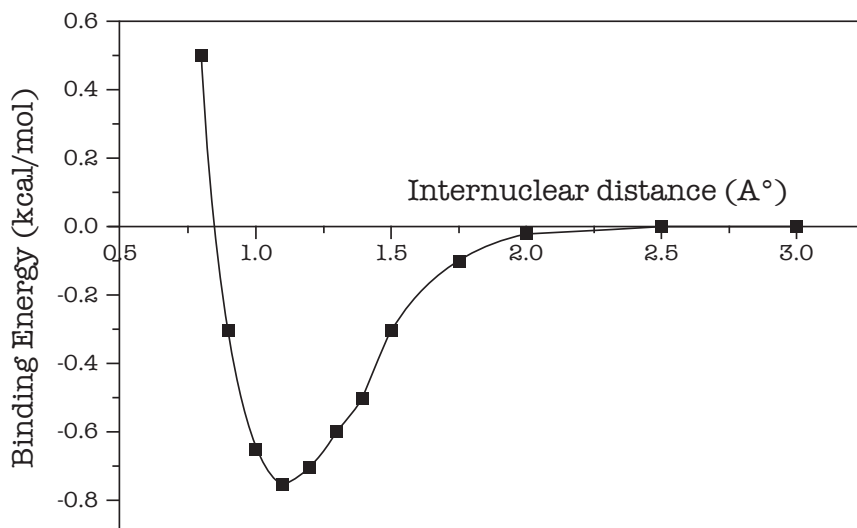

Figure 2: Orbital energies of electrons of atoms of second row elements.



Once the teachers know how to organise input files and read output files to get energies and locate the orbital – electron occupancy, they can calculate valence orbital energies of any atom in the periodic table. Quite a few participants calculated atomic electronic structure of entire periodic

table of elements. To highlight this, extracts from the report of one participant is given in the table below. There is a wealth of information that can be derived from the data. Ground state electronic configuration and energies are correctly predicted by DFT.

Table 1: Orbital energies of electrons in the atoms obtained from DFT

Atom	Orbital energy (eV)	Atom	Orbital energy (eV)
H	-12.95 (1s)	Ga	-5.02, -5.02, -5.02 (4p) -11.39 (4s)
Li	-5.48 (2s) -55.38 (1s)	C	-10.51, -10.51, -10.51 (2p) -18.96 (2s)
Na	-5.34 (3s) -31.28, -31.28, -31.28 (2p) -59.36 (2s)	Si	-8.03, -8.03, -8.03 (3p) -14.76 (3s)
K	-4.38 (4s) -21.14, -21.14, -21.14 (3p) -37.18 (3s)	Ge	-7.66, -7.66, -7.66 (4p) -15.49 (4s)
Rb	-4.32 (5s)	Sn	-7.23, -7.23, -7.23 (5p) -14.09 (5s)
Cs	-3.85 (6s) -15.31, -15.31, -15.31 (5p) -28.5 (5s)	Pb	-6.74, -6.74, -6.74 (6p) -15.28 (6s)
Be	-8.41 (2s)	N	-14.12, -14.12, -14.12 (2p) -25.59 (2s)
Mg	-7.04 (3s)	P	-10.88, -10.88, -10.88 (3p) -24.34 (3s)

Atom	Orbital energy (eV)	Atom	Orbital energy (eV)
Ca	-6.82 (4s) -31.06, -31.06, -31.06 (3p) -50.14 (3s)	F	-22.42, -22.42, -22.42 (2p) -41.34 (2s)
Sr	-5.70 (5s) -25, -25, -25 (4p); -43.06 (4s)	Cl	-17.05, -17.05, -17.05 (3p) -29.15 (3s)
Ba	-5.18 (6s) -21.32, -21.32, -21.32 (5p); -36.26 (5s)	Br	-15.55, -15.35, -15.35 (4p) -27.82 (4s)
B	-7.14, -7.14, -7.14 (2p) -13.00 (2s)	I	-13.95, -13.95, -13.95 (5p) -24.28 (5s)
Al	-5.31, -5.31, -5.31 (3p); -10.35 (3s)	He	-22.16 (1s)
O	-17.99, -17.99, -17.99 (2p) -32.93 (2s)	Ne	-23.02, -23.02, -23.02 (2p) -55.58(2s)
S	-13.88, -13.88, -13.88 (3p) -24.14 (3s)	Ar	-16.21, -16.21, -16.21 (3p) -30.29 (3s)
Se	-12.84, -12.84, -12.84 (4p) -23.64 (4s)	Kr	-14.61, -14.61, -14.61 (4p) -28.49 (4s)
Te	-11.66, -11.66, -11.66 (5p) -20.82 (5s)	Co	-8.95 (4s) -8.96, -8.96, -8.96, -8.96, -8.96 (3d)
Xe	-12.56, -12.56, -12.56 (5p) -24.02 (5s)	Pd	-7.52, -7.52, -7.52, -7.52, -7.52 (4d)
Au	-11.34 (6s) -12.4, -12.4, -12.4, -12.4, -12.4 (5d)	Cu	-8.74 (4s) -9.52, -9.52, -9.52, -9.52, -9.52 (3d)

In molecular calculations, first step is to optimise the geometry by giving the approximate coordinates in relax calculation which is comparable with the experimental bond length. Structure of the molecule given as input was visualised by xcrysden command. Then relax calculation was carried. In this calculation, SCF energy in each step as a function of internuclear distance was assessed. Structure with minimum force on atom was obtained at the end of the calculation. Optimised coordinates are used in the input file of SCF calculation. Mohr's potential curve is very important in understanding the bonding in molecules. Nitrogen molecule is taken as example. SCF calculation was carried for different internuclear distance. Energy of formation was calculated by using formula, $E.F = E_{N_2} - 2 E_N$. A graph of formation energy versus internuclear distance was plotted. Hitherto, teachers drew the plot on the board not knowing how the energies are obtained as a function of distance.

Teachers calculate Mohr's potential for many molecules. You can see this in figure 2 bottom part. For example, in CH_3Cl , H_3C-Cl and H_2ClC-H potential energies can be obtained to remove Cl or H from the molecule.

Post processing like HOMO, LUMO and total charge density have been calculated after SCF calculation. A molecule like water is bent and H-O-H bond angle will be 104.5° even though it belongs to sp^3 hybridisation. This is because the lone pairs are not equivalent as commonly believed by most chemists. HOMO and HOMO-1 orbitals of water are lone pairs but one is perpendicular and another is parallel to H-O-H plane and they are non-degenerate, confirmed by photoelectron spectroscopy in 1962 by D. W. Turner. So, this can be easily verified by DFT calculation. Optimised geometry, shape of the orbitals and total charge density of water molecule are given in figure 2.

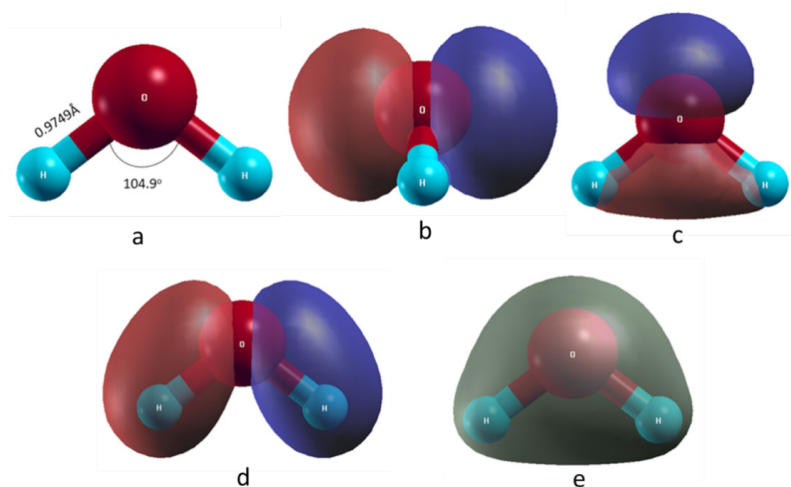
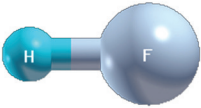
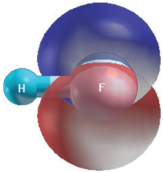
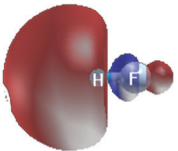
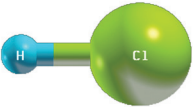
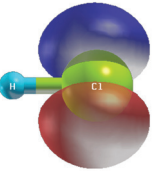
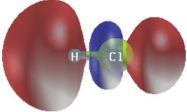
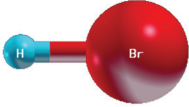
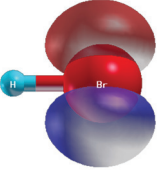
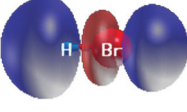
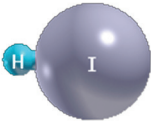
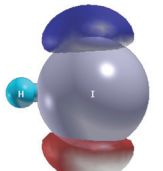
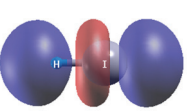

Figure 2. (a) Optimised geometry of water molecule; (b) lone pair perpendicular to H-O-H plane; (c) second lone pair parallel to H-O-H plane; (d) O-H bonding orbital and e. total charge density around H_2O .

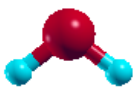

Table 2

Molecule	Bond Lengths (Å°)	Molecule	Homo	Lumo
HF	0.9373			
HCl	1.2879			
HBr	1.4354			
HI	1.0000			

Bond length variation, structure and orbital shapes of hydrogen halides calculated by participants are listed in the table 2. Shapes, bond angles, bond distances, charges on atoms, ordering of MOs of a number of molecules have been calculated by most of the participants. They were given freedom to explore on their own.

From molecular calculations teachers verified the VSEPR theory and hybridisation concept. Various molecules with different hybridisation, shape and their geometry are given in the table 3. Note the agreement between DFT calculations and experimental values from spectroscopy.

Table 2

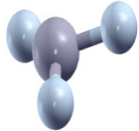
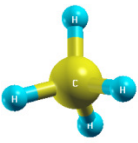
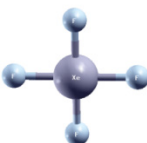
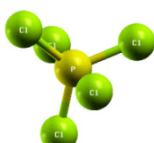
Molecule	H ₂ O	NH ₃	BF ₃	CH ₄	XeF ₄	PCl ₅
Scf image						
Shape	bent	Trigonal pyramidal	Trigonal planar	Td	Square planar	Trigonal bipyramidal
Bond length (Å)	0.9741 (0.9584)	1.0207 (1.017)	1.4142 (1.30)	1.0955 (1.09)	2.0010 (1.94)	2.1444 (2.14)
Bond angle (°)	104.26 (104.5)	107.36 (107)	135 (120)	109.39 (109.5)	90.32, 180 (90,180)	90.06, 120.18,180 (90,120,180)
Binding energy (eV)	-14.1252	-19.4522	-17.9569	-23.9472	-10.436	-17.7536
I.E (eV)	13.1616 (12.62)	11.0637 (10.85)	13.3652 (15.94)	8.2905 (13.6)	17.205 (12.9)	13.4479

* Experimental values are given in bracket

Charge density between neutral and ionic molecules

Electron energies and geometries of molecular ions are calculated by putting the charge in the input file. For example, trihalides are calculated by giving the -1 charge to the linearly arranged three halogen atoms. Formation energy can be calculated by subtracting the total energy of trihalide by halogen molecule and halide ion. Polyanions like MnO₄⁻, CrO₄²⁻, ClO₄⁻ etc. are calculated in the similar way. Charge distributions of these ions are calculated from PDOS calculation.

Indeed, in trihalides, effective charge of terminal halogen atoms is found to be -0.5e and that of central halogen is zero. A cation is formed when a metal ion loses a valence electron while an anion is formed when a non-metal gains a valence electron. They both achieve a more stable electronic configuration through this exchange. It is evident from figure 3 that charge density decreases in oxygen and nitrogen atoms in H₃O⁺ and NH₄⁺, respectively. In anion compound the reverse trend is happened in MnO₄⁻ and MnO₄²⁻. DFT calculation produces experimental data.

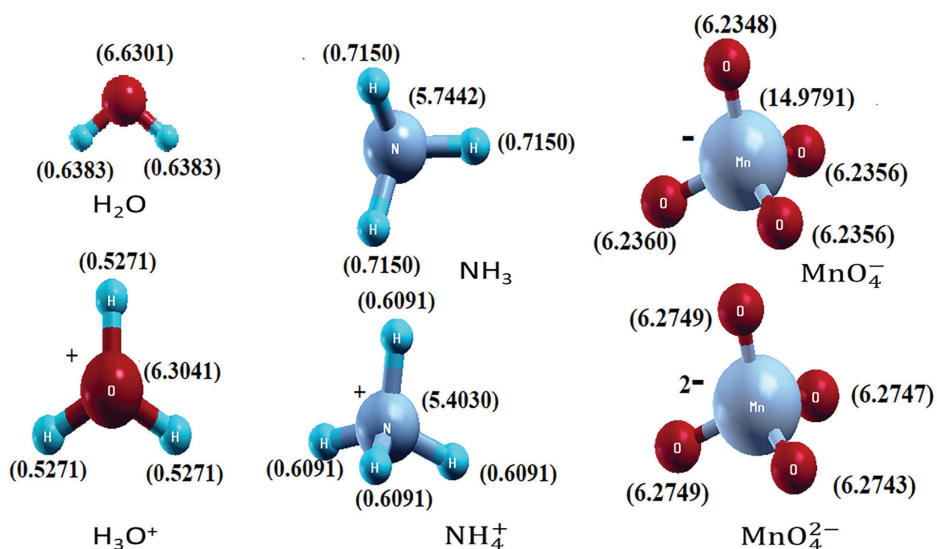

Figure 3: Lowdin charges on each atom of neutral molecules and molecular ions from PDOS calculation.

Teachers start performing calculations on their own. A number of molecules they attempt and get an insight into what QM gives to understand chemistry. Fear of QM goes away. Then teachers are taught how to optimise crystal structure and electronic structure from DFT. All types of crystal systems can be

studied by giving the ibrav number. To calculate the post processing, we need energy of the solid which is calculated by PWscf calculation. Then they can calculate the density of states (DOS) and band structure of solid. Typical calculations teachers reported are given in figure 4.

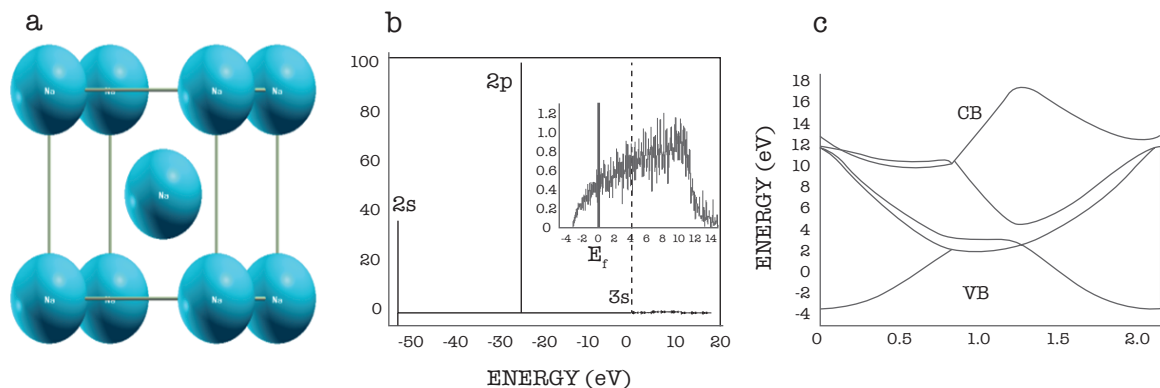

Figure 4: (a) Unit cell of Na metal. (b) DOS of Na metal; inset shows enlarged density of occupied valence state below Fermi level – ve energy and unoccupied 3s and 3p states in Na meatal above (+ve) Fermi level. (c) Band structure of Na metal they can get where crossing of valence band and conduction band becomes obvious.

Sodium metal crystallises in body centred cubic (BCC) system. DOS calculation shows small band like structure near zero energy and core electrons are resembling sodium atom. Band structure of sodium indicates the overlapping of valence

and conduction band. Such advanced level of knowledge can be taught by DFT calculations. Structure and electronic structure of semiconductor Si is obtained by all the participants. This is summarised by one teacher in his report in Figure 5.

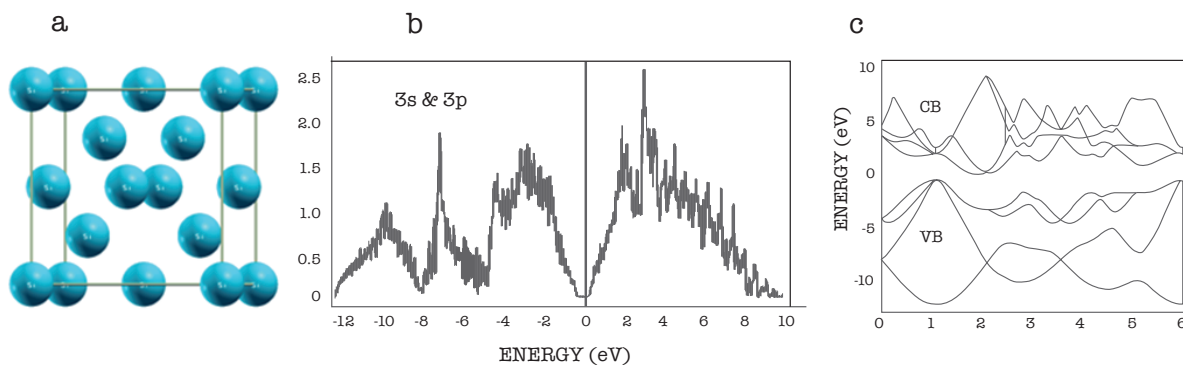

Figure 5: (a) Unit cell of Silicon, (b) DOS distribution in Si and (c) band structure of Si.

Silicon crystallises in face centred cubic (FCC) system and it is dimer. DOS calculation shows electronic states at Fermi level is completely nil. Band gap is visible. Band structure of silicon clearly indicates bottom of the conduction band is displaced from the top of the valence band. Sodium

chloride crystallises in face centred cubic (FCC) system. DOS calculation shows electronic states near zero is completely nil. Band structure of sodium chloride clearly indicates the large band gap between valence and conduction band.

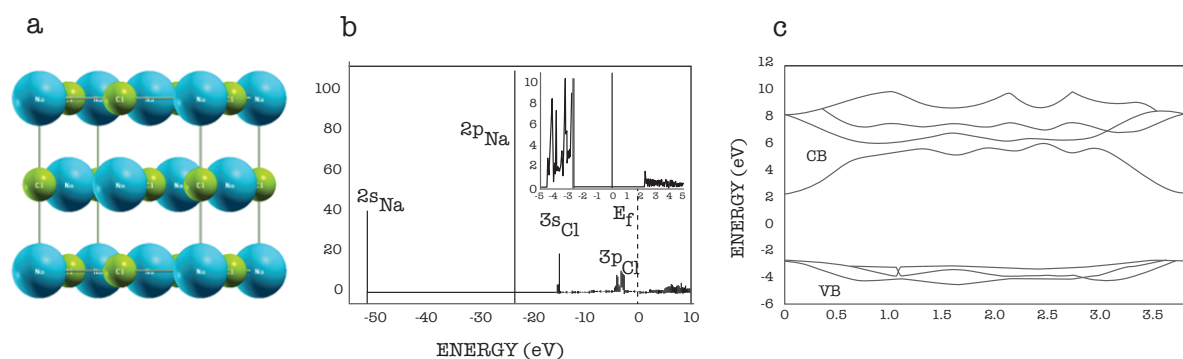

Figure 6: (a) Unit cell of sodium chloride crystal, (b) DOS distribution in NaCl and (c) band structure of NaCl. The teachers accomplish lot more and many after leaving TDC have taken up research employing DFT calculations.

Inorganic Chemistry

Basic inorganic chemistry is learnt by and large in BSc. In the MSc teachers' training at TDC, special aspects of s, p d and f block elements chemistry, molecules and their shapes, molecular orbitals, charge distribution in molecules, polar molecules, dipole moment calculation, ordering of orbitals and their energies are studied. Most of it now can be calculated as shown in the last section by DFT and so inorganic chemistry modern aspects can now be studied with the help of DFT calculations. Teachers are able to derive an insight into the subject directly. Shapes of poly anions – CO_3^- , MnO_4^- and so on, poly cation NH_4^+ , state of non bonding orbitals and their role in chemistry are investigated by the teachers from DFT calculations.

Experiments

The major topic that is studied in inorganic chemistry in MSc is the metal complexes of 3d metals. Splitting of d orbitals generally in tetrahedral and octahedral geometries are taught without any direct measurements of the splitting of d levels given by $10Dq$. TDC found a cheap single beam UV visible spectrometer which is employed to determine splitting of 3d levels from d^1 to d^9 ions and assign the electronic transitions taking energy levels from crystal field theory to MO theory. Importance of absorption coefficients in determining

allowed and forbidden transition are introduced. Teachers are able to relate the allowed transitions and nonallowed transitions from the atomic system to molecular system because they have studied them in the first part of this program by doing experiments. Accordingly, experiments are done by the teachers on: 1. UV-Vis absorption spectra of $d^1 - d^9$ systems transitions and $10Dq$ determination; 2. Effect of Weak-field and strong-field ligands; 3. UV-Visible absorption spectra of Cu^{2+} and Ni^{2+} ions with various ligands and understand spectrochemical series; 4. more intensity of tetrahedral ions vs octahedral ions – both energy and allowedness; 5. Fe^{2+} and Fe^{3+} ion chemistry via d level energies- why Fe^{3+} is more deeply coloured; 6. Charge transfer spectra: UV-Vis absorption due to LMCT in KMnO_4 , K_2CrO_4 , $\text{K}_2\text{Cr}_2\text{O}_7$ and Na_3VO_4 and d^0 energy level of V^{5+} , Cr^{6+} and Mn^{7+} ions and comparison of allowed transitions with molar absorption coefficients; 7. Donor – acceptor complexes – (Iodine – ether complex, iodine – alcohol complex); Table given below summarises data collected by one participant on d^1 to d^9 ion spectra. Understanding of splitting in d^1 to d^9 ions is also explored by the teachers and one can see how much the teacher can accomplish in 2 to 3 days of inorganic chemistry. One teacher compiled spectroscopic data he collected employing a single beam spectrometer and one can see a wealth of information he could get in the experiments he did. Almost all the

participants enjoyed getting an insight into the theory of d level splitting which they observe by doing experiments.

Table 4: Spectroscopic data on the 3d level splitting in the chemistry of the complexes

Complex (C)	λ , nm	A (ϵ , M ⁻¹ cm ⁻¹)	CFSE (Δ_o)	d orbital configuration	Crystal field configuration	Origin of the band
[VO(H ₂ O) ₅] ²⁺ (0.01 M)	754	0.524 (52)	-0.4 Δ_o	d ¹	t _{2g} ¹ eg ⁰	d-d transition: Spin allowed, symmetry forbidden
[Ti(H ₂ O) ₆] ³⁺ (0.24 M)	473	0.687 (3)	-0.4 Δ_o	d ¹	t _{2g} ¹ eg ⁰	d-d transition: Spin allowed, symmetry forbidden
[Cr(H ₂ O) ₆] ³⁺ (0.01 M)	575	0.155 (16)	-1.2 Δ_o	d ³	t _{2g} ³ eg ⁰	d-d transition: Spin allowed, symmetry forbidden
	411	0.149 (15)				
	303*	0.254 (25)				
K ₂ Cr ₂ O ₇ (0.001 M)	370	0.672 (672)	NA	d ⁰	t _{2g} ⁰ eg ⁰	LMCT, both spin and symmetry allowed
	272	0.618 (618)				
K ₂ CrO ₄ (0.004 M)	373	0.393 (98)	NA	d ⁰	t _{2g} ⁰ eg ⁰	LMCT, both spin and symmetry allowed
	273	1.360 (340)				
KMnO ₄ (0.001 M)	526	1.189 (1189)	NA	d ⁰	t _{2g} ⁰ eg ⁰	LMCT, both spin and symmetry allowed
	309*	0.858 (858)				

Complex (C)	λ , nm	A (ϵ , M ⁻¹ cm ⁻¹)	CFSE (Δ_o)	d orbital configuration	Crystal field configuration	Origin of the band
MnSO ₄ (0.1 M)	211*	2.318 (23)	0	d ⁵	t _{2g} ³ eg ²	No visible band d-d transition: both spin and symmetry forbidden
FeCl ₃ (0.038 M)	323*	1.790 (47)	-0.4 Δ_o	d ³	t _{2g} ³ eg ⁰	No visible band d-d transition: both spin and symmetry forbidden
(NH ₄) ₄ [Fe(CN) ₆] (0.33 M)	928	0.573 (2)	-1.2 Δ_o	d ⁶	t _{2g} ⁶ eg ⁰	d-d transition: Spin allowed, symmetry forbidden
Co(NO ₃) ₂ ·6H ₂ O (0.1 M)	690 362* 228*	0.123 (1) 0.198 (2) 1.660 (17)	-0.8 Δ_o	d ⁷	t _{2g} ⁵ eg ²	d-d transition: Spin allowed, symmetry forbidden
[CoCl ₄] ²⁻ (0.003 M)	508 468 300*	0.995 (312) 0.883 (294) 0.220 (733)	-1.2 Δ_o	d ⁷	t _{2g} ⁵ eg ²	Tetrahedral environment, no symmetry consideration
[Ni(H ₂ O) ₆] ²⁺ (0.25 M)	720 659 393	0.540 (2) 0.468 (2) 1.262 (5)	-1.2 Δ_o	d ⁸	t _{2g} ⁶ eg ²	d-d transition: Spin allowed, symmetry forbidden

Complex (C)	λ , nm	A (ϵ , M ⁻¹ cm ⁻¹)	CFSE (Δ_o)	d orbital configuration	Crystal field configuration	Origin of the band
[Ni(NH ₃) ₆] ²⁺ (0.125 M)	927	0.502 (4)	-1.2 Δ_o	d ⁸	t _{2g} ⁶ eg ²	d-d transition: Spin allowed, symmetry forbidden
	571	0.639 (5)				
	358	0.834 (7)				
	230*	2.703 (22)				
[Ni(en) ₃] ²⁺ (0.054 M)	890	0.326 (6)	-1.2 Δ_o	d ⁸	t _{2g} ⁶ eg ²	d-d transition: Spin allowed, symmetry forbidden
	540	0.311(6)				
	245*	1.033 (6)				
CuSO ₄ (0.13 M)	808	1.574 (12)	-0.6 Δ_o	d ⁹	t _{2g} ⁶ eg ³	d-d transition: Spin allowed, symmetry forbidden
[Cu(NH ₃) ₄ (H ₂ O) ₂] (0.03 M)	876	Sh	-0.6 Δ_o	d ⁹	t _{2g} ⁶ eg ³	d-d transition: Spin allowed, symmetry forbidden
	636	2.15 (72)				

Electrochemistry and Kinetics

Basic electrochemistry lectures including cyclic voltammetry are given by a specialist from IISc. Electrochemistry is generally taught reasonably well in the Universities and on demand, only the topics teachers needed were covered – mostly by making them do experiments.

Experiments:

Determination of electrode potentials;
Determination of Avogadro number;

ionic equilibria such as determination of acid dissociation constant (*pKa*) of acetic acid, dichloro acetic acid, ammonium chloride, aniline hydrochloride, phenol by pH titration, determination of *pKa* of amino acids, and testing of buffer action of a phosphate buffer.

MSc teachers are introduced to Cyclic Voltammetry (CV) – a subject in the MSc courses. TDC has developed an electrochemical work station to do CV experiments. Determination of electrode potentials, diffusion of ions,

electro catalysis- evolution of oxygen and hydrogen over electro catalysts- Pt, Pd and many transition metal oxides, preparation of electrodes for electro catalysis are taught to the MSc teachers. This part teachers demanded and hence introduced.

New experiments on kinetics of hydrolysis of t-butyl chloride, kinetics of oxidation of alcohol by potassium dichromate by spectrophotometry employing conductivity meters, and colorimeters mainly to show why kinetic data up to 20% completion of reaction is to be taken to get first order kinetics. Ionic conductivity of Li and Na ions for battery are other experiments explored by the teachers.

All the experimental data were plotted by the participants in origin and prints were taken by them and compiled. They accept that more experiments can be done in the same time period. If it is introduced to the students, reporting experimental results will be more honest, a point made to the MSc teachers during the training.

Structure of solids – X-ray diffraction and Solid-state chemistry

This is another major topic fully covered with a number of experiments. Generally, solid-state chemistry is not covered well in most chemistry

departments because teachers are less knowledgeable.

Experiments:

Determination of linear dimensions and density of solids and liquids, Measurement of defects in solids by density, XRD – indexing of FCC, BCC, simple cubic structure, systematic absences, determination of lattice parameters, atomic radii, packing fraction, structure of metals and ionic solids, analysis of intensity of diffraction lines from structure factor, temperature dependence of resistance for metals – temperature co-efficient α , temperature dependence of resistance for semiconductor- band gap of semiconductor, preparation of nano materials – CeO_2 , TiO_2 , and their characterisation by XRD, temperature programmed reduction – H_2 uptake, Langmuir adsorption, Estimation of oxygen in MnO_2 , $\text{Yba}_2\text{Cu}_3\text{O}_{7-8}$, LaMnO_3 . The following table gives an idea what the teacher could do in the course given the X-ray pattern. TDC has a lower end Powder XRD instrument and teachers record XRD of a number of crystalline solids. XRD of glass powder tells them how XRD distinguishes crystalline and amorphous or non- crystalline solids. Analysis of XRD patterns is taught to them and in table 5, one teacher compiled the data he got.

Table 5: Analysis of XRD data of a number of materials

Solid	hkl	a (Å°)	Unit cell
Al	111, 200, 220, 311, 222	4.051	FCC
Cu	111, 200, 220, 311, 222, 400, 331, 420	3.6153	FCC
Fe	110, 200, 211, 220, 310, 222, 321, 410	2.8504	BCC
Ni	111, 200, 220, 311, 222, 400, 331, 420	3.5237	FCC
Pt	111, 200, 220, 311, 222, 400, 331, 420, 422	3.9231	FCC
CeO ₂	111, 200, 220, 311, 222, 400, 331, 420	5.4158	FCC
Ce _{0.5} Zr _{0.5} O ₂	111, 200, 220, 311, 222, 400, 331	5.2818	FCC
LaMnO ₃	100, 110, 111, 200, 210, 211, 220, 310	3.9897	SC
La _{0.7} Sr _{0.3} MnO ₃	100, 110, 111, 200, 211, 220, 310	3.8824	SC
AgBr	111, 200, 220, 311, 222, 400, 420, 422	5.7704	FCC
CaF ₂	110, 211, 222, 310, 222, 321	4.4725	BCC
NaCl	111, 200, 220, 311, 222, 400, 331, 420	5.5356	FCC
KBr	111, 200, 220, 311, 222, 400, 331, 420, 422, 333	6.5819	FCC
KCl	200, 220, 222, 400	4.3839	BCC

After making the teachers learn indexing X-ray patterns for cubic systems, where they get lattice parameter, packing fraction, ionic and atomic radii, they are taught how to calculate intensity of the diffraction lines from structure factors. Table 6 shown below gives an example of finding intensity of X-ray diffraction lines from NaCl.

Table 6: Intensity of diffraction lines – comparison of observed and calculated values

θ (rad.)	hkl	$\sin \theta/\lambda$	f Na ⁺	f Cl ⁻	f atom	P	L	I cal (4*f _a) ² *P*L	%I = Ical/I ₁ *100	I _{obs}
0.241	111	0.154	8.791	13.18	-4.391	8	32.39	79943.6	8.14	10.81
0.278	200	0.178	8.483	12.30	20.79	6	23.69	982689	100	100
0.398	220	0.252	7.427	10.36	17.79	12	10.73	652637	66.41	46.85
0.472	311	0.295	6.779	9.415	-2.64	24	7.309	19512.1	1.99	2.7
0.494	222	0.308	6.588	9.203	15.79	8	6.57	209748	21.34	13.51
0.579	400	0.355	5.902	8.612	14.51	6	4.62	93580.5	9.52	6.31
0.638	331	0.387	5.445	8.218	-2.77	24	3.800	11221.8	1.14	0.9
0.658	420	0.396	5.300	8.093	13.39	24	3.596	247773	25.21	10.81

This is the bare minimum the students should know in MSc. Sadly, it is not taught in most chemistry and Physics

departments and no wonder why they do not pass NET.

Table 7: Typical solids prepared and XRD patterns indexed by the teachers.

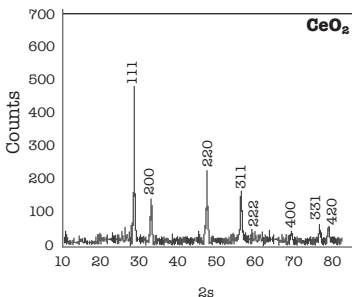
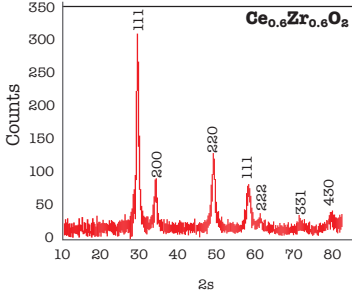
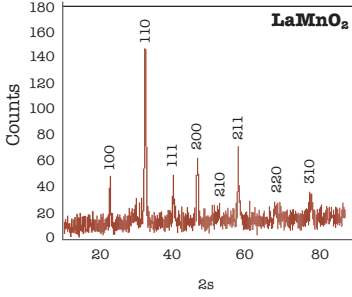
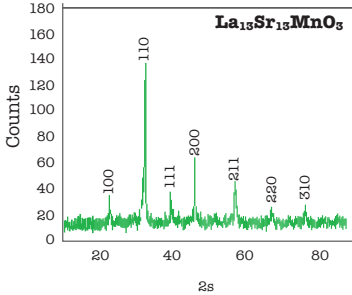
Nano Crystal	Compounds Required		XRD Pattern of Crystal powder
CeO ₂ Colour: Creamy white	Ceric ammonium nitrate	5.48 g	
	Oxalyl dihydrazide	2.83 g	
	Water	25 mL	
Ce _{0.5} Sr _{0.5} O ₂ Colour: Creamy white	Ceric ammonium nitrate	2.74 g	
	Zirconium nitrate	2.15 g	
	Oxalyl dihydrazide	2.60 g	
	Water	25 mL	
LaMnO ₃ Colour: Black	Lanthanum nitrate	4.33 g	
	Manganese nitrate	2.51 g	
	Oxalyl dihydrazide	2.95 g	
	Water	25 mL	
La _{0.7} Sr _{0.3} MnO ₃ Colour: Black	Lanthanum nitrate	3.03 g	
	Manganese nitrate	2.51 g	
	Strontium nitrate	6.35 g	
	Oxalyl dihydrazide	2.77 g	
	Water	25 mL	

Teachers are kept fully engaged for all the days. In addition, teachers are given NET level assignments.

MSc Physics Teachers' Training Program

In the 21 days physics course, teachers do the experiments associated with general physics. Generally, IISc physics professors come for two to three days and in the morning, they give lectures which are followed by experiments on what they taught in the classes. In general, 60 to 70 hours of lectures and 6 to 8 hours of experiments per day together about 180 contact hours the teachers spend in TDC. They accomplish a lot. At the end of the course, they submit a report compiling all the work they did in about 40 to 50 pages. This is a big exercise because they need to present all the results. Since most of them have PhD, they know how to report the results. Subjects covered and the experiments done are strictly within the general physics syllabus for a good MSc degree. What is covered in the 21 days (one afternoon, holiday and residential program) is given below.

A. Basic mathematics for Physics

Curve fitting; Differential equations and special functions; Matrices and tensors; Complex analysis; Integral transforms; Numerical analysis; Group theory.

Experiments: Origin, Matlab and Mathematica software

B. Classical mechanics

Lagrangian formulation of mechanics; Hamiltonian formulation of mechanics; Rigid body dynamics (inertia tensors, Euler angles, rotational matrices); Small oscillations; Introduction to nonlinear dynamics.

Experiments: Atwood's machine, M.I. theorems, Angular momentum conservation, Damp oscillation, virtual laboratory –motion tracker experiments.

C. Quantum mechanics:

Dirac Notation; Quantum mechanical operators; Representation in Discrete and continuous bases; Postulates of quantum mechanics; Schrodinger equations for time independent and time dependent; Angular momentum, rotation and addition of angular momentum; Approximation methods; Scattering theory.

Experiments: Black body radiation, Stefan-Boltzmann law, Hydrogen spectra, Arc Spectra, electron diffraction, virtual laboratory – Density Function theory, calculation of electronic structure of solids – metals, semiconductors, band gap, density of valence states of metals and semiconductors, band structure calculations of metals and semiconductors. DFT is the running theme the teachers work for 10

to 12 days. Teachers become fully acquainted with Quantum Espresso and they can use it for their research. That much is taught in the course glimpse of which are described in the chemistry teachers' training. Physics teachers do all that and more on solids.

D. Fundamentals in electronic devices - theory and experiments:

Network theorems; I-V characteristic curves for p-n junction diode, Zener diode, LEDs, transistor, FET; OPAMP circuits, regulated power supply, oscillators, ADC and DAC convertors, 4 bit counter with 7 segment display, multivibrators.

E. Basic Condensed Matter Physics

Crystal structure and crystal binding; Phonons; Free electron fermi gas and Energy band diagram; Electric properties of material; superconductivity; Magnetic properties of material

Experiments: Density of solids, Thermal expansion, powder XRD pattern analysis including intensity of diffraction lines by Rietveld Analysis, Zeeman Effect, Hall Effect, virtual laboratory – Density Function Theory described above as part of QM.

F. Spectroscopy and Microscopy (Both theory and experiments)

Atomic spectroscopy – emission

from atoms using Ocean Optics spectrometer, FTIR; UV visible spectroscopy; SEM, TEM and AFM; NMR.

G. Modern physics, atomic and molecular physics (experiments only)

Photoelectric effect; Determination of e/m of electron; Determination of Avogadro's number; Bragg's law and absorption of X-rays; Determination of speed of light in liquid medium; Understanding of GM counter; Experiments on beta and gamma source; Compton scattering.

H. Basic electricity and magnetism experiments

Temperature coefficient of resistance; Band gap energy of semiconductor; I-V characteristic of photodiode; Verification of Gauss law of electricity; Lissajous figure; LCR series and parallel resonance circuit; Diamagnetic susceptibility; Paramagnetic susceptibility; Seebeck effect; Peltier effect; Magnetic hysteresis Curie temperature.

I. Electrodynamics (Theory only)

Maxwell's equations in free space and matter; Reflection, refraction, polarisation, interference, diffraction and dispersion; Conservation laws – Charge, energy and momentum; Electromagnetic waves, e.m. waves in vacuum and matter.

J. Heat and Thermodynamics, statistical mechanics and cryogenic techniques

Experiments: Absolute zero temperature; Clausius- Clapeyron equation; Distribution functions- Fermi-Dirac, Maxwell -Boltzmann, Bose-Einstein and Planck's Distribution function; Entropy, enthalpy and Gibb's free energy; Determination of universal gas constant; Vacuum pumps and techniques

Experiments: Diffraction through Helical structure; Solar cell Characteristics; Experiments on Optical Fibre Cable;

K. General advance experiments

Synthesis and characterisation of nanoparticles – sol-gel method and sputtering; Growth of polymer films – electrochemistry, spin coat; Device fabrication using CVD, DC and RF (magnetron) sputtering.

Over 60 experiments related to general physics are done by the participants. All the experiments are done by all the participants. This is indeed a good alternative for UGC refresher courses because experiments related to theory are done by the teachers. In addition, everyday one assignment of the NET level is to be written and submitted by the participants. Overall, a good training module is developed for learning MSc level physics.

MSc Mathematics Teachers' Training: Course Syllabus

- a. Basics (Theory of Equations, Recall: Real Sequences and Convergence, Series, Limits and Continuity of Functions, Differentiation and Integration Techniques)
- b. Linear Algebra: Vector Spaces, Dimension, Change of Base, Linear Transformations, Rank-Nullity Theorem, Rank of a Matrix, Row Rank and Column Rank, Eigen Values and Eigen Vectors, Diagonalization, Cayley-Hamilton Theorem.
- c. Real Analysis: Real Number System, Functions of Several Variables, Continuity and Differentiation, Sequences and Series of Functions, Implicit Function Theorem and Inverse Function Theorem.
- d. Modern Algebra: Theory of Groups, Rings, Modules and Fields.
- e. Numerical Analysis.
- f. Complex Analysis: Continuity and Differentiation, Analyticity, Cauchy-Riemann Equations, Integral Theorem, Residues and Evaluation of Integrals, Maximum Principle.
- g. Partial Differential Equations (Optional).

About 9 to 12 professors from IISc, TIFR, ISI Bangalore spend nearly two days each in TDC. They come with

their research students as tutors to help the MSc teachers solve problems. TDC also has in-house faculty and assistants. A pretest at the MSc level is given to get a feel of how good the teachers are. This also makes the teachers assess themselves: what they know and how much they need to know. The same method as in PU and high school teachers' training is followed for MSc teachers' training. After each lecture, a problem set on the subject just taught in the class is given, and the RPs and tutors help the teachers solve the problems, make them write properly and submit the assignment. Each day, three lectures and three problem-solving sessions are scheduled. After each professor completes one major topic, a one-hour test is given the next morning in the first hour so that the professor teaching the subject will know how effective he was in making the teachers learn. The emphasis is more on understanding concepts as a lot of theory is developed at the MSc level unlike at the BSc. Level.

MSc Biology Teachers' Training Program

The unique feature of this training program is learning biology by doing experiments. This will allow the teachers to understand the concepts and the theories behind the phenomena, and apply their understanding to do new innovative experiments. This 21-day

training program will cover three major branches of Biology: - *Drosophila* Genetics, Microbiology and Molecular biology.

A. *Drosophila* Genetics: Theory and experiments from 1–6 days

Theory: Flow of genetic information through the lens of 'OMICS'; Sex Chromosomes, Sex determination and Dosage Compensation; Mobile Genetic Elements; Genetics of telomeres; Synthetic Genomes,

Experiments: Developmental stages of *Drosophila* (Life cycle of *Drosophila melanogaster* by observing different stages of development); Mutant Morphologies in *Drosophila* (Differentiate between wild type and mutant morphologies of *Drosophila*); Differential gene expression in *Drosophila* using Gal4/UAS system and GFP reporter gene (Gal4/UAS system with GFP and its use in differential gene expression); Gene expression in *Drosophila* using LacZ promoter (tissue specific gene expression using lacZ promoter and blue white staining); In situ immune histofluorescence and study of thoracic muscles of *Drosophila* pupa (Histological expression of thoracic muscles using fluorescently tagged immunological reactions); Isolation of total RNA from *Drosophila* adult flies (Total RNA from *Drosophila* adult flies and crisscross its purity by gel electrophoresis); cDNA synthesis of RNA isolated from *Drosophila* adult

flies (Reverse transcriptase – PCR) and amplification of cDNA using PCR (reverse transcribe and amplify the isolated RNA using random hexameric primers to give complementary DNA product); Behavioural assays to measure the response of *Drosophila* flies/ larvae to different mutations (understanding how mutations affect the behavior in *Drosophila* and to learn to quantify behavioural changes using Image and Graph-Pad Prism software); Observation of polytene chromosome from salivary glands of 3rd instar larvae (study of anteroposterior dissection of 3rd instar larvae for extraction of salivary glands and to observe polytene chromosome).

B. Microbiology – 6 days

Theory: Microbial diversity, Fundamental of immune system, Antigen-antibody interaction; basic microscopy; aspects of microbiology and antimicrobial resistance.

Experiments: Observation of pond water sample (Identification of various phytoplankton, zooplankton bacteria from pond water sample); Isolation of bacteria from different natural samples, screening for α -amylase, Lipase and Protease production and characterisation for physiological properties; Partial purification of proteins using salt (ammonium sulfate) precipitation. Extraction and characterisation of pigment from bacteria isolated from different natural sources.

C. Molecular biology: 6 days

Theory: Genetic engineering and Biotechnology; theoretical aspects of Chromatography; Cell signalling.

Experiments: Bacterial Transformation I: Transformation of *E. coli* DH5 α (introduce plasmid (pET22) with desired insert in cloning strain *E. coli* DH5 α); Plasmid DNA isolation from transformed cells of *E. coli* DH5 α : MiniPrep (Isolation of clonally replicated plasmid pET22 with desired insert from *E. coli* DH5 α); Restriction digestion of isolated plasmid, agarose gel electrophoresis and gel elution (crisscross the presence of desired vector and insert in the isolated plasmid); Bacterial Transformation II: Transformation of expression vector of *E. coli* BL21-DE3 (transform plasmid isolated in previous experiment into *E. coli* BL21 –DE3); Protein expression and purification from *E. coli* BL-21 – DE3 strain (To express protein of interest in bacteria transformed with recombinant plasmid containing gene of interest and purification of protein by affinity chromatography); Expression and purification of RFP and GFP from recombinant bacteria *E. coli* BL 21 strain. From Day 19 and 20 given time to prepare for Report writing and submission.

Interestingly we have continued these MSc Teachers work and published their bacterial sequence in NCBI- GenBank Accession Number MN252371.1 and MN252364.1.

Experiences with MSc Teachers' Performance

Each one submitted a report fully typed with all the details. Since most of them had PhD, it was possible to demand a report. Trainings for MSc teachers were conducted in 2018 and 2019. Each one did so much during the course that it was a satisfying experience for us in the faculty. They all enjoy reasonable well-equipped laboratories to learn MSc level experiments. In mathematics we did conduct tests and results are very good. Our approach of providing good program for the core subject seems a

good idea. Mathematics teachers took first and the last test and results below indeed confirms the training method adopted indeed works at all levels. You can see the pattern of performance of teachers is uniformly low before the training meaning the teachers need training to increase the level of learning in high school, PU, BSc and also MSc. It is also important to realise that almost all can be trained consistently to make them score over 80% marks on a standard paper. This did make a difference on the performance of students as shown in chapter5. The method of training works.

University and PG College Msc Teachers Training Program in Mathematics 2018

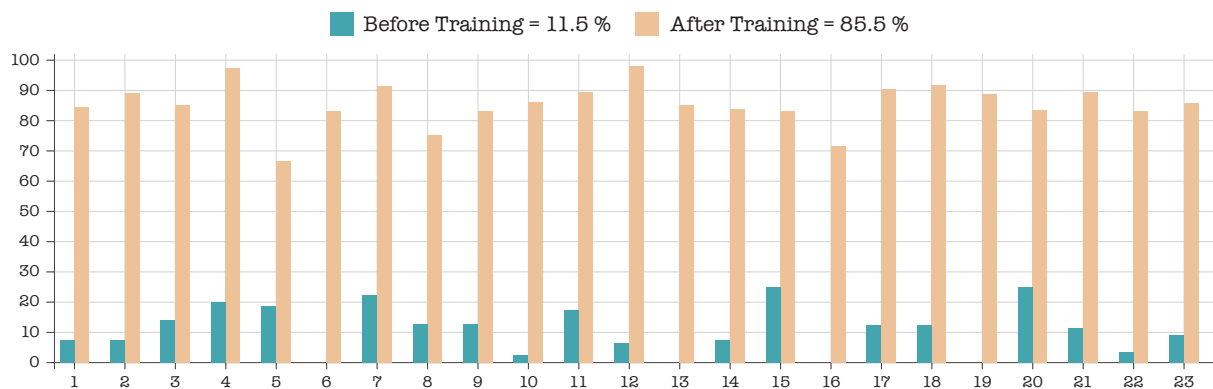

University and PG College Msc Teachers Training Program in Mathematics (16-06-2019 to 06-07-2019)

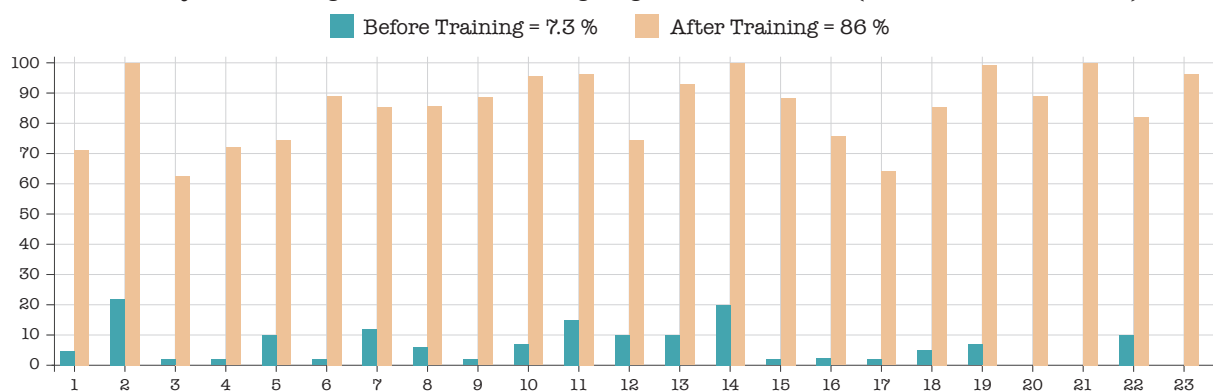

Laboratory Instruments for Schools to Universities

Schools and colleges started during British India included a science laboratory. Lecture halls were designed to conduct demonstration experiments with a sink on the table, AC power sockets on the table to conduct demonstration in the class rooms and big cupboards to stack experiments for demonstration. Lecture rooms/halls with gallery was a norm so that each student can see the teacher doing the experiments. In one such school, Gibb High School, Kumta, Uttara Kannada district (Estd. 1909), I studied in the years 1958 to 1962. Those days, high school was 4 years and PU was one-year duration. All the science classes were conducted in the science laboratory. Science teacher conducted at least one experiment in a 40 min class. Learning science was an excitement. Even now 90% of high schools in Uttara Kannada district of Karnataka has a science laboratory

following the Gibb High School model. Expansion of education could not take care of science laboratory in a school for a long time after Independence. Finally, Govt. of India has taken major initiative to improve both primary and secondary school education since 2000.

Sarva Shiksha Abhiyan, SSA, is a Govt. of India program aimed at the universalization of elementary education. This was pioneered by former Prime Minister Atal Bihari Vajpayee in 2001. This is a flagship program for primary education.

Realising the importance of laboratory in high schools, Rashtriya Madhyamik Shiksha Abhiyan (RMSA) was started by MHRD in 2009. Important physical facilities provided under the scheme are: (i) Additional class rooms, (ii) Laboratories, (iii) Libraries, (iv) Art and

crafts room, (v) Toilet blocks, (vi) Drinking water provisions and (vii) Residential Hostels for Teachers in remote areas. The scheme is being implemented by the State Government Societies established for implementation of the scheme. The central share is released to the implementing agency directly. The applicable State share is also released to the implementing agency by the respective State Governments. SSA/RMSA is headed by an IAS officer. Under this scheme, as of today, each Govt. school is getting at least Rs 25,000 for laboratory facilities. Both SSA and RMSA are administered by a separate wing of Education Departments of State Govts.

Rashtriya Uchchattar Shiksha Abhiyan (RUSA), "National Higher Education Mission" is a holistic scheme of development for higher education in India initiated in 2013 by the Ministry of Human Resource Development, Government of India. The centrally sponsored scheme aims at providing strategic funding to higher educational institutions throughout the country. Funding is provided by the central ministry through the state governments and union territories (UT), which in coordination with the central Project Appraisal Board monitor the academic, administrative and financial advancements taken under the scheme. A total of 316 state public universities and 13,024 colleges are covered under 12th five years plan in 2013. This program in 2019 is at

various stages of implementation. For example, from the minutes of RUSA meeting on 24, January 2019, under the chairmanship of the Secretary, MHRD, several decisions are taken: Creation of Universities by Conversion of Colleges in a Cluster, Infrastructure Grants to Universities (Target – 50 Universities; Approved - 21 @ 20 Cr each), Upgradation of existing Degree Colleges to Model Degree Colleges (Target- 75 Colleges, Approved – 62 Colleges @ 4 Cr each), Enhancing Quality and Excellence in select Autonomous Colleges (Target- 70 Colleges; Approved – 46 @ 5 Cr each), Infrastructure Grants to Colleges (Target – 750 Colleges; Approved – 749 @ 2 Cr each), Research, Innovation and Quality Improvement (Target- 20 Universities; Approved – 16 @ 50 Cr each), MOU with TATA INSTITUTE OF SOCIAL SCIENCES, MUMBAI and such decisions are taken.

All the three national programs, SSA, RMSA and RUSA are fully active under MHRD. What does it mean to people working in education sector in India? The Central Governments in coordination with the State Governments provide funds to improve education from primary school to university education. It is up to the Education Institutions to utilise the program to provide quality education. How TDC can make use of RMSA and RUSA to infuse quality education in high schools, Colleges and Universities? This is the question we need to address.

Creation of New Experiments to Learn Science

Most of the small high school and PU level instruments are manufactured in Ambala. These instrument companies were started during British time historically. Very little improvement has been brought by these companies. They have remained essentially family run small businesses. They are marketed all over India. Kamlajeet Education Instruments in Bangalore is one of the leading physics apparatus manufacturing company. Almost all the engineering colleges in South India buy experiments from him prescribed in the Engg. Physics of first and second semester. Most of the PU and BSc colleges are dependent on this company to produce those experiments which are prescribed in the experiment part of the syllabus. It turns out that Jitendra and Anil Kumar, ex-faculty members of Mangalore University Physics Department started repairing non-working instruments and finally made a company. They have innovated a large number of physics instruments which are the back bone for physics experiments at least in South India. Obviously, they would not venture to make experiments kits which are not prescribed for laboratory experiments as part of curriculum because nobody buys them. This is the level of competence in the Physics Instrumentation in India for colleges to University.

IISc started four years (8 semester) BS (Research) degree UG program majoring in Physics, Chemistry, Biology, Mathematics, Environment Science and Materials Science in 2011. For all the students, $12 \times 3 = 36$ credits in PCMB for three semesters is common. The courses are based on 2:1 credit meaning 2 lectures and one afternoon laboratory a week in each course. In addition, they have to do 18 credits of engineering – Computer Science, Electronics, Data Handling and two more Engg. Courses from among the ME first year courses. Compulsory Addition of 18 credit (out of 129) of Engg. courses is distinctive feature of IISc BS program. IISc faculty has designed the laboratory program such that whatever the theory lectures are covered in a week is followed up by experiments in the same week as far as possible. For this they needed instruments. They have opted to buy from reputed instruments for undergraduates from USA and Germany in addition to buy whatever is available in India. Laboratories are equipped with large sum of money to the tune of Rs. 20 to 30 crores. Of course, laboratory is a huge attraction for UG students. They receive BS four years degree as good as in best US universities. Indeed, many get admitted for PhD in Cambridge, Stanford and such great Institutions.

TDC conceived the idea of designing and developing new experiment which

are not available in the market. Idea of designing equipment for the laboratory experiments prescribed for the PU, BSc and MSc is one aspect. This will be only limited number of experiments on the total syllabus. The major idea in TDC was to design experiments covering entire syllabus. This was because the program undertaken is to train the teachers in a shortest period of time where teachers should learn full subject doing experiments. As experienced in TDC, once experiment is done by a teacher, his understanding on the subject was far deeper than just listening from lectures. This can be a unique experience to learn science in TDC. For doing most of the experiments, instruments are not available in India. Cost will be huge and prohibitive if imported. No college can afford them. The instruments so designed should be affordable if the schools and colleges want to equip them. The instruments/experiments should give accurate results desirable at each level otherwise the purpose of doing experiments and verifying the facts is lost. Eventually, students should be able to access the instruments to learn science.

TDC set out to design new experiments to be done by the teachers. The model employed was as follows: Fabricate the first working model. Make second generation kit and improve them. Make them with the help of local science instrument companies. Sometimes, improve or modify the ones available

with the instrument companies by interacting with them. Make the teachers do the experiments on the new kit and see how it is accepted by the teacher. Bring out near final model and move to next experiment. Sometimes the experiments need to be developed with the help of the engineers in the company given the idea and knowhow by TDC. Sometimes the first model fabricated needs to be made more professionally acceptable instrument. With this model, we worked with entrepreneurs to develop instruments. Techno Science Instruments was one such company who were very good in designing and developing instruments. They had a full backup of mechanical workshops in Bangalore. Since TDC did not have a good mechanical workshop, we had to depend on them. Instruments created jointly were identified with a joint logo.

Glassware and glass apparatus were comparatively easier to fabricate. TDC has a glass blowing workshop. Two of the assistants were trained at IISc Bangalore glass blowing shops. So, a lot of glass apparatus were developed in TDC itself. Standard glass wares are well developed in India. Several good companies are able to make glass apparatus designed by us. Chemistry and biology experiments were relatively easier to develop. Due to advances in medical instrumentation, biology experiments were developed. For example, electrophoresis apparatus for protein separation

which was costing over Rs. 75,000 per unit was modified with the same accuracy costing about Rs 10,000 by the interaction with another company BIOBEE in Bangalore. Standard binocular microscopes up to 1000 magnification were identified at a relatively low cost.

The experiments listed in Appendix A to C for high School, PU colleges and degree colleges are largely developed by TDC. It is not sufficient to have apparatus. Actual experiments have to be designed so that the experiment teachers carry out should explain science they read in the books prescribed. This needed a lot of thinking and effort.

Another area TDC excelled was to make the experiments simple by combining components. Outdated method of hooking up the components were avoided. The experiments are now performed with the state-of-the-art instruments. Yes, further improvements may be needed. That is for the future.

Equipping the Schools with experiment Kits

Sometime in 2016, Karnataka Govt. asked TDC to give two sets of experiments to each of 12 schools. That is when we had to really work on the cost, manufacturing and reproducibility. This too was done. 150

experiments for high school covering 8, 9 and 10 class science could be provided for about Rs. 150,000. It works out to be Rs 1000 per experiment on an average which is quite cheap. Most of the experiment kits last long. Consumables for the chemistry and biology experiments is of the order ten thousand rupees. Overall, school should be able to manage for quite some time. TDC cannot manufacture instruments and sell. TDC has no such manufacturing facility and also manpower to make them. It is here the entrepreneurs created by TDC had to make them and sell. The Govt. gave grants to TDC and we had to procure the instruments and give them to the schools.

Govt. under RMSA used to give kits that were mass procured under tender. Quality was not supervised and most of the apparatus given to the schools have remained unused as seen by visiting the schools. Presently RMSA is giving money to the schools for them to buy what they want. Even though amount involved is about Rs 25,000, honesty to properly utilising the funds is lacking. However, the trained teachers demanding proper apparatus has resulted in purchasing better quality instruments. By working with RMSA, TDC can bring together the entrepreneurs and RMSA to suggest the schools for buying good quality instruments.

Manufacture and supply of experimental kits

It has already been stated that science should be learnt by doing experiments many times by now. For this we need quality experimental kits. The basic requirements are: these experimental kits must be mechanically sturdy, portable and easy to setup. On the technical part, they should be modern, reliable, accurate and routinely working. The results produced using these kits must be repeatable. Also, the failure rate must be minimal. Though we get to see a lot of companies manufacturing these scientific kits and equipment in India, it is Ambala in Haryana that we see a big concentration of such companies. According to a document produced by the Ministry of MSME, Govt. of India, there are about 3,536 registered industrial units in Ambala spread across four industrial zones, engaged in the manufacture and supply of scientific instruments. These companies produce a variety of equipment for the use in schools, colleges and universities. They also supply small items required for demonstration such as magnets, compasses, wires, meters, tubes, tuning forks, pads and so on. Electronic and electrical items include digital and analog timers, ammeters, voltmeters, stop watches, etc. Full-fledged and standalone equipment for BSc and MSc level in the area of Chemistry, physics and biology as well as engineering, are made in plenty

and supplied by these companies. An estimated annual turnover of these small-scale industries is about Rs. 600 crores.

However, the quality of these experimental kits or equipment is not up to the expectation level. First of all, they are not elegant and modern in look. They continue to use old styled switches, knobs, meters, etc. Technically they are poor in performance. The results are only good enough to the level of demonstration and cannot be used for reporting or verifying with the values reported in literature. For example, there is no standard experiment kit in physics to do Boyle's law and Charle's law verification (PU level experiment) available to give accurate results. Similarly, the Atwood's machine (BSc level experiment) available in the market is just at the demonstration level. Unfortunately, all the schools and colleges including KV, JNV are forced to buy these substandard level instruments and teach their students, as there is a dearth of good quality instruments. In TDC, we tried with Ambala made setup initially. But they were so clumsy and cumbersome to use that we finally decided to make our own units. It may not be exaggerating to mention that we could produce finest, yet low cost and easy to setup units for many experiments such as linear thermal expansion of metals, specific heat capacity of liquids measurement, Avogadro's number determination

using constant current source, Boyle's law and Charles's law verification, etc., which give very accurate results.

So, what is lacking in Ambala industries which are engaged in manufacturing these instruments? Firstly, there is no R&D Centre available in Ambala for continuous improvement. There is no investment in R&D to bring in innovation either by the government or the companies. Second, there is no universal standardisation for these instruments and each company adopts its own quality and technical standards.

Third, there is a severe scarcity for innovation at design and fabrication stages. Industries are not keeping pace with latest trends in instrumentation. For example, even today, Ohm's law verification setup or similar other experiments such as network theorem verification, etc., are supplied with analog ammeter and voltmeter, instead of digital meters. Needless to say, that the digital meters give more accurate results with better resolution (decimal accuracy) than their analog counterpart. Another problem that can be cited is the tough competition among the large number of companies making same product line leading to poor quality of these products, as there is a great pressure on them to keep the prices low in order to sell. These companies cannot compete at the international level to export their products.

Discrepancy between the real need and availability

Another big problem that we face while teaching science through experiments is the big mismatch between the need and the availability. Many concepts have to be taught only on theory as there are no experimental setup available. For example, we don't get experiment setup to carry out Oersted's experiment in electromagnetism, Newton's laws of motion and many others. Even if we want to assemble different parts to construct an experiment, certain critical items are not available. A highly accurate digital timer with 0.1 milli second readability is not at all available, which is very much needed for the study of laws of motion and other time dependent experiments. Similarly, an accurate digital thermometer with 0.01-degree resolution is simply not available. Old Beckmann thermometer which would measure 0.01 K accuracy is no longer produced and so depression of freezing point, elevation of boiling point, specific heat measurements and all the experiments in thermodynamics are removed from the list of experiments to be given to the students. Yet the theory is included in the syllabus. All we need is temperature measurement up to second decimal place to do so many experiments in physical chemistry and physics. We have to do with whatever available and compromise on results. Most of the instruments in the market are standalone type. There is no

integration possible. For example, to carryout meter bridge experiment, 5 different items are needed: DC voltage source, decade resistance box, galvanometer, commutator and meter bridge board. These have to be individually connected to construct an experiment. If only the first four items could be integrated into one unit, the whole setup becomes simple. This had to be done in TDC. By this innovation and improvement, time to set up the experiment is saved. Also, there is no company willing to manufacture any customised instrument according to our specifications. This is because, each company is indulged in mass production of their products and hence there is no time for any custom-built product development. Also, any new product development needs capital infusion, which they cannot afford.

Problems with ordering and procuring instruments

Logically speaking, if there is a supplier available, one should be able to place an order to procure any instrument. But there are many hurdles in the process. There are many rules such as three quotation requirement, tender calling procedure for placing a purchase order. There is no flexibility in procurement procedure from a single vendor even when he is ready to design and fabricate customised instruments. Special resolutions

need to be formulated under such circumstances and all institutions may not have a provision for such an arrangement. Three quotation itself is a fraud most of the time. Generally, a single vendor arranges three quotation and his will be lower. Can an institution like IISc afford such arrangements? With great difficulty we could convince some entrepreneurs to fabricate many instruments according to our design guidelines. But there are numerous problems faced by these small-scale industrialists. First, they need to agree for small volume manufacturing which is basically a less rewarding. Secondly, the whole process of ordering, procuring and bill settlement extend up to several months, which makes the whole deal least profitable. Besides these vendors are asked to supply the products at low cost leading to loss as the volume of sale is low. Even if the products are superior in quality, the customised instruments cannot compete in price with Ambala products as many schools and colleges prefer to spend less money rather than spending on good quality instruments. Added to this is the investment problem. Local entrepreneurs cannot infuse big investment in order to manufacture world class instruments. Also, there must be a huge market for such products. Government also has no clear-cut policy to encourage and finance such small-scale entrepreneurs to make in India finest quality instruments and supply to local demand, which can be later expanded

to cater to world market through exports. Though there are big slogans and announcements in budget about “make in India”, practically there is not much implementation on the ground. The MSME segment all over India is facing severe problems such as low demand, capital crunch, productivity issues, loan repayment pressure, scarcity of quality man power, off take of the products, due to which several hundreds of such units are getting closed down.

Another issue with vendors who come forward for making customised fabrication is that they need to be assured of a reasonably good order with at least 100 numbers, without which it will not be sustainable for them. Only government bodies can buy in such big quantities to distribute to schools, or some big companies can sponsor such donation of science kits to schools. In such a scenario, there needs to be a policy in place to have a memorandum of understanding between the government agencies, the sponsors and the identified vendor to make and supply the experimental kits to schools. In addition to this, the schools should be allowed to use their RMSA fund or any other grant money to buy directly from the contracted vendor so that all the procedural delays are avoided. This method helps for the speedy delivery of experimental kits to the schools who can then use them effectively to teach science to the students. This

way the vendor will also be happy as he gets assured order and the assured payment. TDC, IISc has played a vital role in this aspect where more than 100 schools have been given science experimental kits including physics, chemistry and biology subjects, either through government grant or through company sponsored CSR grant.

Therefore, making money available to improve the school education is not sufficient. A lot of issues that come in the way to finally provide better instruments have to be solved within the framework of rules and regulations. Training teachers is only one of the aspects. Providing instruments to do experiments in schools is another issue that needs to be solved even with grants made available. Since TDC and IISc is part of overall system, methods to overcome issues mentioned have to be solved so that final goal of delivering good science education become possible.

Impact of Experiment Kits given to Schools on SSLC results of Students

First the science teachers training to large number of teachers was accomplished at TDC. To train the teachers, new experiments were designed, developed, fabricated, multiplied and facilities for training science teachers was put in place. Then came how to proceed to make

the schools equipped with superior instruments for the teachers to impart good science education had to be organised. Final recipients of knowledge of trained teachers are the students. In chapter 5 we have given results on how the schools are performing with the trained teachers to enhance percentage of scores both in science and mathematics. In most schools, teachers also innovated, took out some experimental facilities to teach science and indeed they could do well in making students score higher marks in science. We experimented how the students do when the teacher and the schools have experimental facilities to teach science. A few schools were given complete set of experiment kits. The schools indeed used these facilities and students are really excited to do the experiments themselves – the picture below is from one such Govt. school in Arasikere of Madhugiri district.

Karnataka DST Karnataka Govt. gave funds to give science kits. This school was chosen by the Govt. We gave the kits in 2016 and the students are now taught science doing experiments in the laboratory. Students also could do some of the experiments.

Before he was trained without experimental kits, 27% of the students have scored more than 60% marks in science paper. Average marks scored in science was 55%.

The teacher was trained in Sept. 2015 after the SSLC examination in 2015. In Dec. 2016, the school was given the experimental kits. Name of the teacher is G. H. Renukaraj. In 2019 SSLC examination, 97% of students scored more than 60%. Average marks scored in science paper is 75%. Only one student in 39 scored less than 60%. This is the power of trained teacher teaching science with experiment kits.



Exciting the students in the schools by making them do the experiments given facilities by TDC.

Can we make all the schools perform like this? On average, additional 15 to 20% of students are able to score more than 60% with the experiment kits given to a trained teacher. The message is clear. Students are good. They can be taught to do well provided the teacher knows the subject and teacher has the facilities to teach science via experiments. Many schools have now been given the kits and the teachers are applying their mind. TDC experiment, "LEARN SCIENCE BY

DOING EXPERIMENTS" indeed works at school level.

All the teachers want the new experiments for their schools. For this a systematic effort has to be put in to provide kits. This is a huge task. There are 8,000 Govt. and Govt. added high schools in Karnataka. Economics of providing the facilities is Rs 120 Crores which is not unreachable by the Govt. But few care for better education for our children. Method to equip and

2015 RESULTS

SCHOOL CODE: DA0189 | AVERAGE MARKS: 55 % | PERCENTAGE OF STUDENTS SCORED MORE THAN 60 MARKS: 27 %

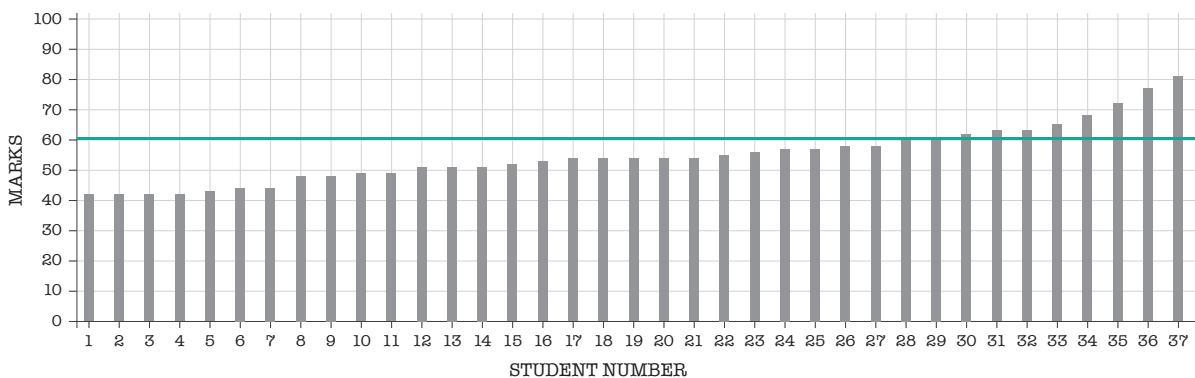

2019 RESULTS

SCHOOL CODE: DA0189 | AVERAGE MARKS: 75 % | PERCENTAGE OF STUDENTS SCORED MORE THAN 60 MARKS: 97 %

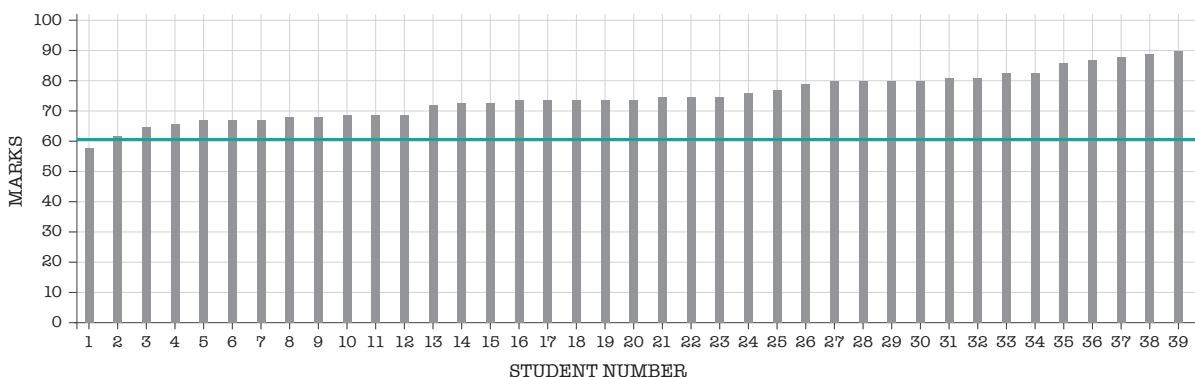

the logistics involved are other serious issues. Production of high-quality instruments is the main issue. Even if money is available to the headmasters ordering from authorised vendors is yet another issue. Recently, KREIES on our recommendation gave 45 schools Rs. 1.5 lakh to buy the equipment / Instrument we had made on which the teachers were trained. 40% of headmasters bought the right ones but the rest found it profitable to spend money buying inferior quality equipment which will not serve the purpose. So, it is not sufficient if we train teachers but the system has to be made more honest.

Unless our children study science as in advanced countries with experiments, we will not progress. What we have shown is how a large percentage of students can receive excellent science and mathematics education first by training the teachers and follow it up with affordable science experiment kits.

From our own fund, two JNV schools were provided 240 experiments for PU students. JNV authorities inspected and found that the experiments given and the teachers making use of them indeed enhanced the performance of the students. In addition, excitement of learning science was huge. At least a few JNVs have bought kits from the Instrument Companies such as Techno Science, BIOBEE and Kamaljeeth. The idea needs to be pursued to make JNV

and KV adopt a good policy to provide good experiments kits. They have faced the problem of how to purchase superior experimental kits which has been described earlier.

From our own funds, we had provided full 300 experiments to two-degree colleges at a cost of 10 lakhs. Impact is that these colleges organise one day workshop to propagate the idea of doing experiments and learn science. We are invited for the functions. Lot more has to be done to follow up to implement good experimental practices in colleges.

Scaling Up Science & Mathematics Teachers' Training

An account of teachers' training at TDC since 2011 has been presented in chapters 1 to 9. Over 9,000 high school, 3,500 PU, 400 BSc and 200 MSc teachers have been trained till 2019. Problems associated with learning science and mathematics were studied in depth. Education level is low primarily because of lower levels of knowledge among the teachers. A novel method of learning science by doing experiments and mathematics by solving problems at each level were found to be effective to bring the teachers' knowledge to an acceptable level. Methods is disseminated through residential training program. Quantum of knowledge gained by the teachers and the extent to which they have been successful to translate their knowledge to the students have been estimated. Performance of students before and after the teachers trained

is evaluated. This is a giant experiment where the entire Karnataka high school teachers are taken for training. Results confirm a huge improvement on the quantum of learning by the students in science and mathematics.

The method adopted here in TDC seems to work in enriching knowledge of teachers. The key to the success, if we agree, is the method of training. Engaging the teachers intensely after making them realise they need knowledge was implemented. There are teachers who go out and express that it is a difficult program. But learning is a difficult process. It turns out that those who are not able to do well are the ones who complain. Over 95% of teachers feel they needed such a training and express their gratefulness to TDC and to the State Govt. for providing an opportunity to learn. "At

least once I must go and get trained in TDC" is a common desire of those who have not come to TDC. Teachers invited second time are keen to come and spend another ten days. We do not think TDC has any other choice than making the training serious effort of learning. Dr Abdul Kalam during his visit on Nov. 18, 2011, studied what TDC is doing and examined the trainees. After that he summarised TDC effort as follows:

"TDC makes the teachers gain knowledge in science and mathematics by making them work hard. TDC makes the teachers more honest." Later he gave one-hour lecture on how an honest and good teacher makes the students come up.

Can there be any other way to make the teachers capable to learn subject? Is there another way to teach teachers to learn and make students successful in the respective examinations? One criticism on our approach can be: it is too much examination oriented. At the end of each level of learning, be it high school, PU, BSc or MSc, each and every student can have a certificate only by passing with high marks in a set of written examinations. Students in this competitive world have to have marks in their favour to succeed. How will a student score high? Teacher who taught must be able to answer all the questions to make the students write answers correctly. An easy way is to introduce tests for the teachers. True,

they have passed with high colours in their time. But the training should also provide a method for them to make the students learn and score. Novelty of TDC training is the method of imparting knowledge and the testing method evolved to find how much the teachers have gained after receiving the training. It is a quantitative measure. The method evolved is fully open. All the question papers and answer papers after evaluation are returned to the teachers. No part of the examination or teaching process is kept secret. So far not even one teacher has expressed that the question paper was out of syllabus. Performance records of all the teachers are fully documented in TDC. In absence of any other viable method to train teachers, we have adopted the present one. Writing correct answers to a question is important than just knowing the answers. That is all about the tests.

Is the Training Program Successful?

Quick answer is yes. To answer this question, we should ask: what is expected from the teachers trained? That the teachers have learnt and gained substantial knowledge is seen from the marks they have scored after the training. We have tested them in about 5 to 7% of the knowledge they have gained and what they need. This is inbuilt in the testing procedure. At least 85% of the teachers have scored

more than 60% marks after the training in comparison to just 15 to 20% marks average over all the teachers before the training. Therefore, the training program is to be accepted as successful.

Analysis of SSLC results given in chapter 5 indeed confirms second level of success. Successful teachers are able to make over 50% of students to score more than 60% marks in science and mathematics papers. Average marks scored is more than 70%. Percentage of teachers who could achieve this is over 60% in mathematics and over 72% in science. What we are talking is over 5,000 schools. Such a large-scale experiment is undertaken for the first time in India. Similar analysis has to be done on the successes of students taught by the PU, BSc and MSc teachers. Obviously, a lot more needs to be done to make the program a standard prescription for implementation.

Another indicator of success is that teachers have changed their approach. Writing the answers on the black board and make the students pass in a SSLC exam hall, popularly known as BOARD EXAM was most common mode to get high passing percentages in 2011 in many districts. TDC training and the Govt. effort have made the teachers change their attitudes and honesty is leading the way. Certainly, the direction has changed from unacceptable methods towards honest method. The

very fact that over 50% students from among the successful teachers/schools are scoring over 70% marks indicates honesty has won. To us, this is more gratifying. Year by year improvement is another indicator. We firmly believe, society will be more honest when the children are taught honesty in schools.

In the draft report on New Education Policy, Govt. of India MHRD, training teachers is one of the strong recommendations to tide over the current problems of lower level of learning at each stage. Many of the issues raised in the chapters concerning teacher's knowledge and the inadequate support from the Govt. are discussed in the draft NEP. Here is a model training program for teachers' training to teach basic sciences. It is in basic sciences where the teachers need training. Therefore, we venture to propose how to scale the teachers' training programs to entire India.

How to Scale-up Science and Mathematics Teachers' Training?

We have dealt with science and mathematics education in TDC. We limit our proposals only to basic sciences and mathematics education. In chapter 1, why basic science and mathematics is more important than any other subjects is presented. IISc was created as a university of higher learning and research. IISc has built

up research in basic science and engineering sciences over 110 years. India is weak in basic sciences and therefore the idea of science and mathematics teachers' training at TDC was evolved.

During the first two years, we have been inviting a few faculty members from Colleges and State Universities to teach High School and PU teachers. I used to brief them. One of the Professors from Gulbarga University came to teach biology to PU KVKV PG teachers. After about 45 min, there was a commotion in the class room - teachers attending were angry that he could not answer questions. Inference is that he could not offer more than what he did to his MSc students. KV PG teachers who are selected from many Universities certainly were of higher level than MSc students of one typical university. Few other times we faced difficulty to make the trainees happy. Since then, we stuck to professors from IISc, Indian Statistical Institute, TIFR, JNC to teach the teachers. High school teachers are also taught by IISc Professors. This made a huge impact on teachers. Training became successful to the extent described here mainly because of choice of Professors to teach from these advanced Institutes. I have always called them Professors which is a distinguished position in these Institutions. We have avoided getting professors from outside Bangalore due to cost factors and also, we could get full support from IISc itself.

Advantage of Professors from the Institution teaching the teachers is their commitment to time. It is indeed gratifying that in 9 years, over 200 training programs in TDC have been conducted and not even once a lecture announced has been dropped. Such regularities are maintained only in IITs and IIT Kanpur claims such punctuality last 60 years.

Social Responsibility of National Institutions

Very few engaged in the educational system in India pursue research on how to raise the level of learning science at each level of students' career. There are a number of issues such as how to teach science at various levels such as how to create laboratories replacing outdated facilities, how to create novel experiments following the latest developments in science, how to enable learn science in a shorter duration, how to train teachers, how to implement good laboratory science programs in degree colleges, how and who will develop instruments and experimental facilities, how to raise the level of learning science prescribed in the syllabus, how to raise the competence of teachers to international level, and how to enable the motivated students to come and work in science at any level to quench their curiosity. Answers to these can come by Research in Science Education.

Institutes of National importance such as IITs, IISERs, and Central Universities engaged in Science and Mathematics research have been working only for their students. Needless to say, they are all autonomous institutions of National importance. They serve a small percentage of students, less than 0.05% to 0.01%. In these institutions course instructor brings in innovation. They are fulfilling their commitments to teach their students and do research, publish papers and bring credit to their institutions, in turn to the Nation. Possibly, the newer aspects of knowledge developed gets transmitted to other institutions through the students of these advanced institutions appointed in the degree colleges and universities and not by any other process. These National institutions do not have a mandate to look into issues of higher education in India. Hence, they are not involved to improve the science education across state universities. The students who may find jobs in colleges and state universities may bring higher levels of their knowledge. But, percentage of students from the Institution of National importance in the State Universities is very small, limited to less than 10%. Nation has spent large sum of money to create these Institutions. If superior knowledge in these institutions are to be percolating to the less fortunate College students, it is essential for the National Institution to fulfil their responsibilities. Therefore, we propose Institutions of National importance must step in to enhance

Science and Mathematics Knowledge to the State Govt. and other institutions who need their knowledge. In the map below we have indicated distribution of National Institutions.

Pandit Madan Mohan Malviya National Mission on Teachers and Teaching, MHRD

Pandit Madan Mohan Malviya National Mission on Teachers and Teaching (PMMMNMTT) has instituted over 45 centres from 2015. Participating in the presentation of the progress report of this mission, we got a feeling that most of them are not having the training programs as conceived and implemented by TDC IISc. There are three centres of Excellence in Science and Mathematics Education; IIT Guwahati, IISER Pune and IISc. From what one can read in the PMMMNMTT portal, IIT Guwahati has had MOU with SSA and RMSA of Assam to train the high school and PU teachers on the similar ideas of TDC, IISc. IISER Pune has been inviting teachers for one to three days and they are motivated through enquiry-based learning following methods adopted by Universities in UK. Mandates for other centres widely vary. A large number of universities and institutions under PMMMNMTT are busy with methodology - BEd and MEd education which are not content enriching programs and not useful to the teachers. Whatever each institution was doing towards improving education was continued

instead of innovation to impart quality science and mathematics education to teachers. There was no evaluation of teachers training programs in PMMMMNMTT by an academic body. Essentially, UGC refresher like programs continued under the new name PMMMMNMTT. Joint Secretary Rakesh Ranjan wanted IISc like programs which he expressed in a few meetings. As of now, there seems to be little unanimity among the participating institutions on the teachers' training as the mission PMMMMNMTT is supposed to deliver. However, IISc is continuing its commitment to PMMMMNMTT as proposed in 2015 which was accepted and duly sanctioned. To best of our knowledge, our program has tried to address the issues related to lower level of learning science and mathematics. Learn science by doing experiments and learn mathematics by solving problems is new. Evaluation of the knowledge gained by the teachers is courageous and novel. Reader of this report can judge on the merit of TDC program and can suggest improvements. As of now, in absence of any other benchmark training science and mathematics teachers at four levels, we venture to propose how to scale up the training program TDC has conceived.

A Proposal for Scaling up Teachers' Training

What is clear from the experiences gained at TDC, only the Institutions

of National Importance which have a strong base in basic sciences can take up science teachers' training. That is because they possess higher levels of knowledge. Over 60 centres of higher learning is at the command of the Govt. Each state has minimum of two such Institutions. We propose that at least one such TDC be established in each state to train science and mathematics teachers.

For perspective planning Karnataka is taken as an example for upscaling the training program. Improvement in education is a continuous process. Therefore, the teachers training, a new dimension to be added to the existing education system is to be a permanent feature just as a university continues to stay for all time to come. IISc has conceived the idea and a permanent place – TDC under Skill Development Center is established in its new campus at Challakere.

NITs have relatively weaker science research programs. Only recently, they have started admitting MSc students in Science and Mathematics. In our opinion, research and teaching in pure science programs in NITs are of the same level as those of State Govt. Institutions or Universities.

We are not suggesting that all State Universities are not good enough to take up teachers training. They are already burdened to teach large number of students and perhaps are

unable to handle the existing program themselves. In addition, they are already doing what they can to impart best possible knowledge.

It should be a natural commitment on the part of National Institutions to take teachers training and not by imposition. It will fail if there is no willingness to part with their knowledge to less fortunate teachers who could not make it be in these Institutions.

Distribution of Centres of Higher Learning in India

In Karnataka, there are about 16000 high school science and mathematics teachers in government and government-aided high schools. There about 3000 PU PCMB teachers, together with JNV and KV, there are 5000 PU PCMB (all India) teachers. There are about 1800 BSc college teachers and about 1600 university teachers in PCMB. If the teachers have to receive training once in eight to 10 years, TDC has to train 1600 high

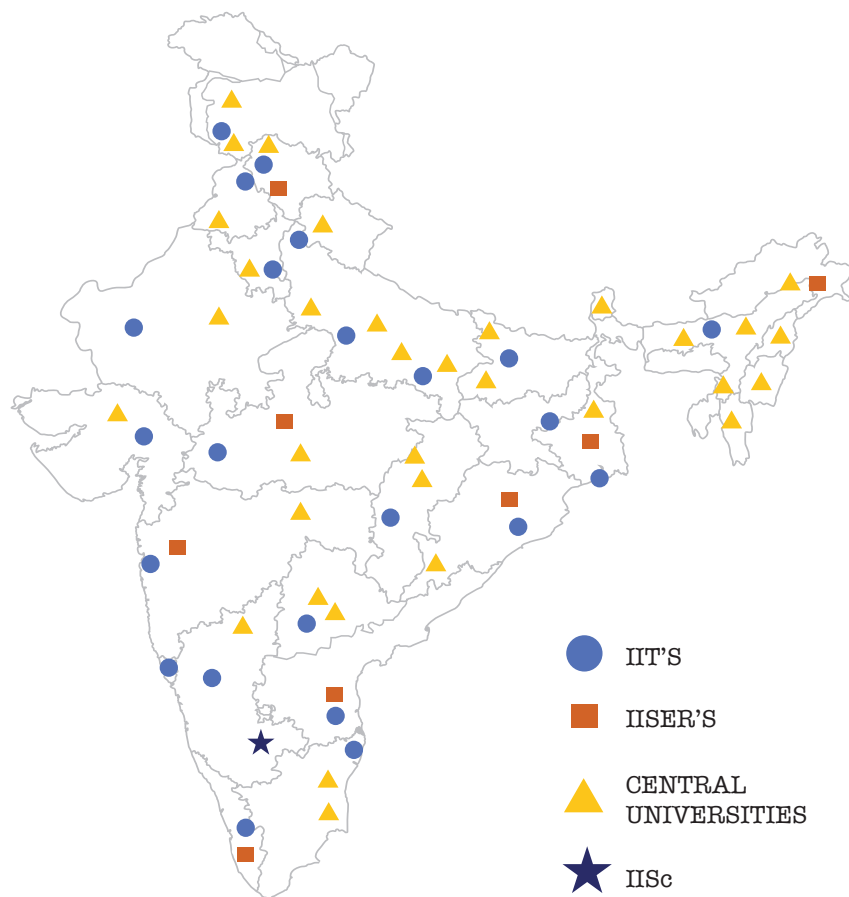

school, 800 PU, 180 college and 160 university teachers per year. This adds to 2700 teachers. As of now TDC is training about 1800 teachers per year. IISc is spending about 300 to 400 lakh per year given the infrastructure namely building to conduct the training about 200 teachers at a time and hostels for 200 teachers at a time. Increasing the number to 2500 is planned and so in Principle, IISc can take care Karnataka.

If 40 TDCs or equivalent centres across the country are established and a target of training 2500 teachers, 100000 teachers will get training per year. Entire country is covered. Cost of training 2500 teachers is about 400 lakhs including equipment and residential expenses. The total recurring expenditure for 40 centres is 160 crores per year. One crore students get benefitted per year. In 10 years, most teachers will have good training. There will be near uniform standard of learning across India. This is highly cost effective. The proposal is to open one department of Science education, exactly similar to TDC, IISc in each IIT/IISER/Central Universities. If it becomes another department of education with old BEd and MEd, as in all the Universities, the entire purpose is lost as it happened to PMMMNMTT. Science Education Departments in IITs should be better than TDC IISc in terms quantitative enhancement of knowledge, enhancement of level of learning by the students taught by trained teachers. IISc can take lead in making a detailed project report.

Overall approach should be to train the teachers internationally competitive at each level. For example, make the university teachers in chemistry as good as their own institution. This is the perhaps the overall outcome and insight gained by the giant experiment at TDC IISc training teachers at four levels of Science.

Looking Back and Looking Forward

Talent and Skill

Talent: Natural ability. Talent refers to special often athletic, creative, or artistic aptitude, general intelligence or mental power; ability, the natural endowments of a person, a person of *talent* or a group of persons of *talent* in a field or activity.

Skill: The ability to do something well. Skills refer to an ability or an expertise in performing a task, obtained by a person through systematic learning, practice or experience. It is the outcome of continuous efforts and improvements made to gain proficiency.

Skill needs talent.

I do not know who has coined the name "Talent Development Center" (TDC). Obviously, men sitting below

the IISc tower have given this name. In the context of teachers training at TDC, inherent assumption is that teachers have talent and create a system to develop their talents. In addition, TDC in general help develop talent among the people working in TDC.

Personal reflections- looking back

Men and women are gifted with talents. Many a times, large section of population do not have access to learn from those who are talented. Learning process starts at home. We go to schools. Teachers teach students to become skilled and bring out talents hidden in them. For that you need to be lucky to have met teachers who possess both skill and talent. Somewhere along one starts thinking.

Inculcation of thinking process helps one to become skilled and give an insight to express his/her talent. There was a strike on some issue by the students when I was a student in IIT/Kanpur. Then the director Dr. MS Muthanna addressed the students in front of library. He asked us if we come to library. All of us raised our hands. Then he asked us, have you read what is written on the beam above the door when you enter the library? There was silence. He showed us what was written: THINK. All of us had missed that!

I was worried what I will do to spend time after my retirement. I wanted to take up something which I cannot complete or I cannot master in full so that I have a permanent occupation. I had some interest to learn chanting Vedic Mantras as they are called. Sometime around 2000, well before my formal retirement from IISc, I found a guru and started learning Veda- mainly chanting. Mantras should be chanted 100% correctly. It suited me. When professor Balaram in December 2009 asked me what I am going to do after retirement, I had Vedic studies in my mind. He prodded me to go to Challakere to create a teachers training center. I had little idea what was expected of me. If I had taken up Veda, only I will be happy. If I take up teaching teachers science thousands of teachers will get benefitted. I can continue to learn how to chant Vedas. So I accepted to come to Challakere Campus.

Goals of TDC got defined. With whatever skill and talent I had in me acquired during my life (I was 65 years of age then) I have put to use and tried to develop TDC with total support from the Institute. I have learnt a lot during the last 10 years. Primary objective of TDC was to produce training-teaching modules for high school to university teachers in basic science- PCMB. Innovation, design and development of instruments and experiments at affordable cost is the activity which consumed my time with the support of TDC staff and a few professors from IISc Bangalore campus.

Chitradurga-Bellari region gets maximum amount of Sun rays in India. Residential training has a huge advantage. Starting the classes at 8 with a tea and biscuits at 7 am, breakfast after an hour of lecture at 9, lunch at 1-30, tea at 5-30, dinner at 8 pm schedule gives at least two hours extra time to work. This also gives the teachers that they can work more. Splendid isolation makes people think. Productivity increases.

How to remember?

I have spent considerable time on how we remember what we have learnt. I have enquired, searched literature and asked many people. I could not get a satisfactory answer. How our brain works is the most difficult subject

to comprehend. It is a wonder how we remember enormous amount of knowledge and we retrieve them. Is there a short cut method to remember? This question arose because teachers were expecting that by sitting in class and listen the lectures they will remember whatever is taught. General expression is: I had learnt but forgot. My thoughts were: how to make the teachers remember what is taught.

After a year or more, one day I felt I know the answer. It occurred to me that I remember the mathematics tables which I had learnt 70 years ago. Analyzed how I remember. By sheer repetition or chanting tables $1 \times 1 = 1$ to $20 \times 10 = 200$ tables over 300 hundred times when I was five to six years old, I remember tables. After that I had never chanted the entire sequence even once next 70 years. Yet I remember. Tables are taught even today in schools. Everyone remembers in India mathematics tables fully and correctly. Even those who do not know writing also remember it correctly.

During the process of learning Veda, I stumbled upon one mantra called Chamaka, chapter 7 of Kanda 4 of Yajurveda. It is melodious to chant a mathematical odd number sequence 1, 3, 5, ----, 31, 33 and 4, 8, 12, ---- 40, 44, 48 an even number sequence with difference of 4. There was no god in these sequences as we normally attach to Vedic mantras. A large number of such sequences are written in second

chapter of Kanda 7. Quickly I realized that the tables must have evolved and by hearing tables just as mantras were practiced. Vedic period is about 8000 years old from now. Even today, there are literally 100s in Gokarna, Karnataka who chant entire Rigveda requiring about 10 days, 8 hours each day without seeing a book and without a mistake which I have witnessed. Obvious question is how do they remember? I found that there are 8 methods of remembering propounded in Rigveda. I learnt a few for my own sake but I thought I can share this with the teachers. I made a 45 min lecture on "how to remember". Chanted a few mantras demonstrating I can remember more complicated hymns than the tables and explaining the idea of how to remember on 3rd or 4th day of 10 days training after 5-30 pm.

I have avoided religious bias totally and carefully. Start with question: how to remember? Lecture start with tables and end with tables. It was truly effective. To remember lifelong you need to chant or repeat to yourself many times. I ask the teachers: how will you remember the subjects taught in the class by listening once? Read and write at least 10 time. Message is taken by the teachers.

Many teachers came and told me that Quran is remembered and chanted by a similar method. Bible – chanting during marriage in churches and also for funerals (to which I attended) is also

done by Fathers on a similar line.

Instead of just preaching the teachers that they should practice and do hard work, we used many methods to influence them. Rain drops form a stream, then a river and all the rivers end up to sea. All the actions in TDC should make the teachers learn what they do not know within what they need to know. This is the overall philosophy. Dr. Kalam at the end of one hour power point lecture to about 5000 teachers on 8th November in TDC concluded: "LOVE OF PEOPLE IS LOVE OF GOD". We have built up an attitude to "love teachers" in TDC.

Science, Scientists and Society

After one or two training programs, we realized that we should not waste teachers' time on generalities and functions, garlanding dignitaries, conducting extracurricular activities. We provided in-door and out-door games and no one was interested. Focus was on learning contents of the book the teachers need to teach. We needed an hour to evaluate the final test paper. It occurred to us that we end the program on what science has given to us. We tried to highlight this by a lecture on "Science, Scientists and Society" since 2011. In 2019, Indian Academy of Sciences conducted a discussion meeting on Science, Scientists and Society in the faculty

hall of IISc. My lecture at the end of a training program and the discussion meeting by IAS had only the title in common. It was a power point lecture with a few demonstrations. Works of about 30 scientists were highlighted starting with Isaac Newton. We show how fundamental research of men of eminence makes the world livable. Contributions of Newton, Maxwell, Michael Faraday, Neils Bohr, Albert Einstein, Linus Pauling, Watson and Crick, GN Ramachandran, Graham Bell, Louis Pasteur, CV Raman, SN Bose, Ramanujan, Wolfgang Pauli, Richard Feynman, Vikram Sarabhai, Sathish Dhavan, UR Rao, CNR Rao, Abdul Kalam, MS Swaminathan and so on were highlighted. Care was taken to relate the contributions of men of science to the subjects they studied in 10 days. The lecture made the teachers at least for a few minutes that they are part of science and be proud. End the lecture with a slide on Gandhian Philosophy:

**Truth is God and God is Truth;
TDC message: Science is Truth and so
Science is God.**

Drive home that one should be truthful. The lecture is followed by a feed-back session, announce the final results, give small gifts to those who scored 100% marks in the last test and send the teachers home after 10 days. In a day or two the next batch of teachers come and repeat the cycle.

Equipping Schools with Experimental facilities

To transfer knowledge acquired by the teachers during the training in TDC to their students, schools should have adequate facilities and experiment kits/instruments. RMSA addresses these issues. TDC has produced experiment kits at affordable cost. Through CSR grants, nearly 100 schools have been provided these kits and we have monitored how the teachers make use of them to teach science. We have not been able impress upon the State Govt. to take it up as part of their policy. Production and delivering mechanism is too scanty to make any impact. I accept that it is a weak spot in our scheme of improving the high school education. We gave JNV schools and a few colleges the kits they should use to teach. It is also ineffective. A lot has to be done to mass produce affordable instruments, make the schools and colleges to acquire them. Suitable provision should be in place for the teachers to teaching with experiments and demonstrations. NCERT has not yet noticed our work to increase level of learning science. A movement similar to WHITE REVOLUTION (production and utilization of milk) by Manibhai Desai and V. Kurian is essential. TDC is too small to make such a revolution of quality science education across India.

Self-reliance in Scientific Instrumentation is extremely weak in India. Way back Electronic Corporation

of India Lmted (ECIL), a wing of DAE was established to produce equipment for scientific research. ECIL did a lot of excellent work but it is not visible today. As mentioned earlier, most of the scientific instruments needed for research are imported. Here is the case for "Make in India". Only when instruments are made in India, they become affordable. Models of how to become self-reliant is provided by ISRO and DAE. It is essential for other Science and Technology departments in India take note of such a huge deficiency. I must confess, TDC and IISc has not produced leaders to impress upon the Govt. on this crucial part of science education. Indian Education Institutions have huge capability to make whatever we need to improve science education. For example, costly ventilators for Covid patients are made at 10% cost of imported ventilators by IITs. I am sure, once covid19 is gone, Indian effort to provide cheaper ventilators will also vanish.

Looking Forward: New Education Policy 2020

Education system up to class 12 or up to PU is essentially retained with some structural changes. The NEP has introduced four years undergraduate (UG) degree program. UG in arts, science, commerce, law, education are going to be four years just as BE, BTech, Medical and other professional

four year degree programs. A move from three years to four years is truly a welcome initiative. In the chapters 1 and 7 we have discussed it extensively.

There is a lot of emphasis on “Teacher Education”. The policy fully recognizes the primacy of teacher to make the education system strong in India. Full implementation of NEP is expected to take place by 2030. For example, a four year BEd or four year BSc with one year BEd graduates teaching high school classes is likely to take place by 2030. It will certainly improve the education level in schools. But need to train teachers described in chapter 3 has to continue. Therefore, in hind sight, IISc - TDC is 10 years ahead of 2020 NEP. This is further substantiated by the fact that IISc is the first Institute to have introduced four years BS in 2011. As a dean of science faculty in IISc from 2008 to 2010, I was deeply involved to develop curriculum for four years BS in six majors, physics, chemistry, biology, mathematics, material science and environmental science. Personally it is gratifying to find that many of the good features of IISc four years UG program are reflected in the NEP.

Curriculum development introducing skills in the UG programs with option to exit with a certificate after one year, with a diploma to exit after two years and UG degree with a major after four years all have to be designed and implemented. With total breakdown in the education system

due to corona, few are addressing this issue as of Sept. 2020. TDC has knowledge and expertise to take lead on how to implement NEP in terms of curriculum development for four years UG degree in science. TDC has created experiments, instruments and a method to learn science by doing experiments during the last 10 years. Experiment on science teacher training at all levels has addressed a lot of issues raised in NEP and has come out with solution.

Realizing the importance of teachers training at all levels, specifically in science subjects, Indian Institute of Science with the support from HAL created SKILL DEVELOPMNET CENTER in its new campus. Success of TDC in the old sheep breeding farm led to creation of facilities for training 200 teachers at a time in the new campus. The giant experiment to train teachers continues in the new campus.

*IISC Challakere
Campus Gate*



*Skill Development Center,
IISC - Callakere Campus*



Physics laboratory



Hostel
Complex



APPENDIX A: High School Experiments

In the following, we have given short write-up on each experiment for the reader to know what are the experiments designed and developed for high school teachers to learn concepts. The following experiments are performed by every teacher during the High school teachers' training.

HIGH SCHOOL PHYSICS EXPERIMENTS

1. Determination of linear dimensions and density of solids and liquids*

Measure the dimensions of regular shape objects by using a digital caliper to calculate volume. Measure mass by a digital balance. Mass/volume is density with proper units. For irregular shape objects density is determined by buoyancy method.

This is a TDC designed experiment. means the experiment is designed and developed newly for the training in TDC.



2. Determination of g, acceleration due to gravity

$g = 4 \pi^2 (L/T^2) \text{ ms}^{-2}$. Measure L and T and get g in ms^{-2} . Vary L and mass and prove that g does not depend upon mass and length of pendulum. Measure time by digital timer with 0.01 second accuracy. Method to measure time correctly is introduced here in TDC.

*Digital timer is new for the teacher.

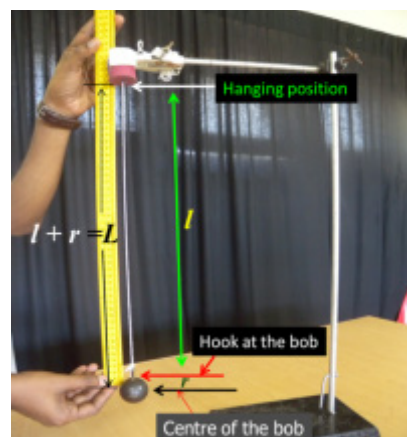

3. Determination of spring constant*

$\mathbf{F}_R = -k\mathbf{x} \Rightarrow \mathbf{F}_A = k\mathbf{x}$. Plot extension (\mathbf{x}) versus applied force (\mathbf{F}). Determine k in \mathbf{Nm}^{-1} .

Plot mass vs x to obtain k from the slope. Repeat the experiment with different springs.



4. Conservation of energy and frictional loss*

In this experiment, we verify the law of conservation of energy and determine the frictional loss. $\frac{K.E}{P.E}$ and $P.E. - K.E.$ gives frictional loss by a simple method developed here. Potential energy and Kinetic energy are measured in this new instrument developed by TDC.

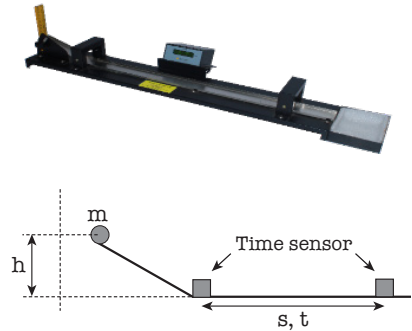

5. Projectile motion*

Determine the angle of projection for which range is maximum and plotting the graph, Range versus angle θ gives a maximum range at $\theta = 45^\circ$, as expected. This is a new instrument for range measurement.

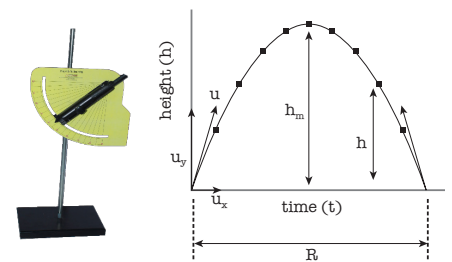

6. Determination of velocity of sound – Resonance column*

Here we find the velocity of sound in air at room temperature using a simplified resonance column. Verify the velocity of sound at 0°C and show that sound velocity depends on temperature.

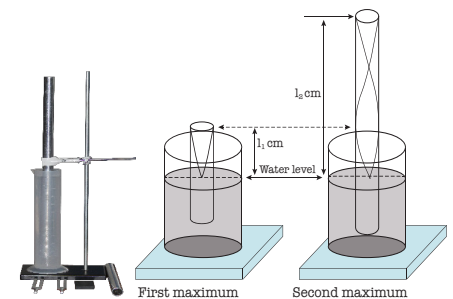

7. Measurement of atmospheric pressure by Hg barometer*

Here we measure atmospheric pressure using mercury barometer.

$$P = \rho gh \text{ Pa}$$

$$H = 0.76\text{m};$$

$$\rho = 13590.5\text{kg/m}^3;$$

$$g = 9.81\text{ms}^{-2}$$

$$P = 101.325 \text{ kPa}$$

In Khudapura $h = 71.5 \text{ cm}$. Hg. $h = 13.6 \times 71.5$ is the water column height. This is used for Boyle's and Charles' law later.

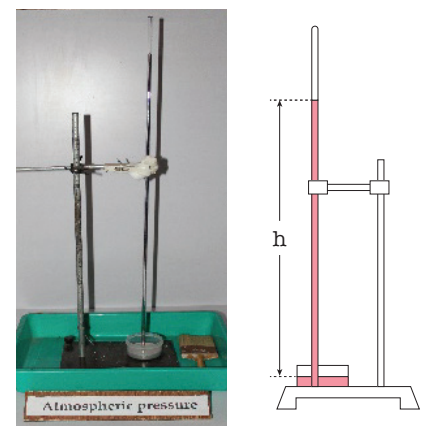

8. Application of atmospheric pressure*

Manometer is a U-shaped tube with both ends open. The tube filled by water is called tube level to determine the level differences used by a mason. This experiment is a direct application of atmospheric Pressure – Sea level is same on earth. They can measure height of a step. It's a demonstration experiment.

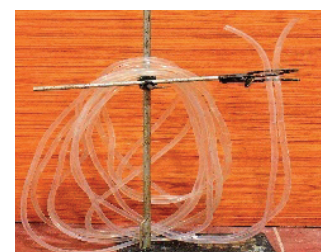

9. Boyle's law*

In this experiment, we verify Boyle's law by changing pressure and volume at constant temperature. i.e., PV is constant at constant temperature. Here we use water column to find the pressure instead of mercury column, an innovation at TDC. An inverted burette is used to measure volume of air.

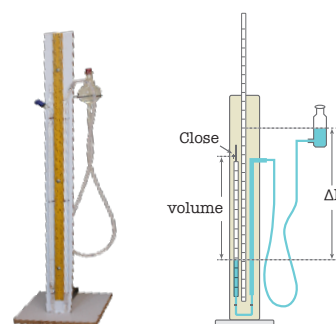
**10. Gas Law (Gay-Lussac law) / Charles' Law***

Charles' law and Gay-Lussac law state that pressure is proportional to temperature at constant volume. This is verified here. A one litre glass bulb connected to a manometer is dipped in hot water, pressure and temperature are measured from Δh and plot of P vs T shows straight line. At constant P , $V \propto T$ is difficult to perform. We plot t (temperature in $^{\circ}\text{C}$) vs P to get a st. line.

**11. Determination of Absolute Zero***

In this experiment, the relationship between pressure and temperature of given gas under constant volume is measured from room temperature to -190°C using liquid nitrogen. Plot of P vs temperature gives absolute zero, -273°C .

**12. Linear thermal expansion coefficient***

Here linear coefficient of thermal expansion of wire is measured. The wire is heated by applying current which expands. By applying Pythagoras theorem, one can find linear coefficient of thermal expansion of a metal. Accuracy is 1 mm in 1000 mm.

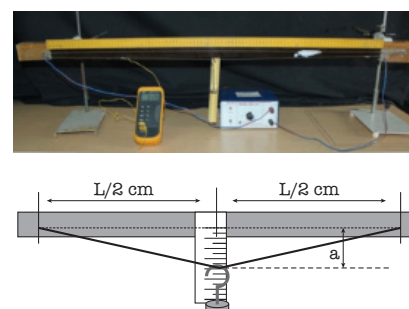
**13. Volume expansion coefficient of liquid***

We determine volume expansion coefficient of water and different liquids. Here we use a burette to determine volume expansion coefficient of liquid.

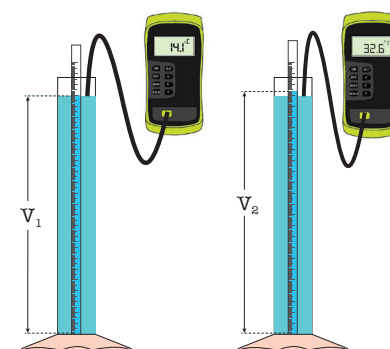

14. Siphoning of liquid*

This experiment is an application of pressure. An inverted U-tube used to drain water from water reservoir which placed over a higher level. It's a demonstration experiment.

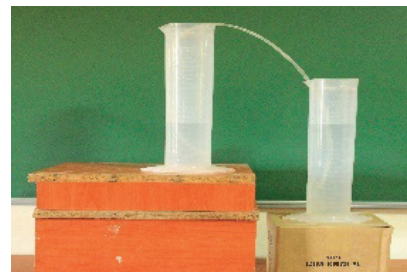
**15. Heat conduction***

In this experiment, thermal conductivity of different metals is determined by directly feeling the heat conduction by fingers.

**16. Heat convection***

Hot liquid moves up to transfer heat. This type of heat transfer is called convection. The fluid above a hot surface expands, becomes less dense, and rises. A demonstration experiment.

**17. Determination of flame temperature***

In this experiment, we find the flame temperature of spirit lamp using K type thermocouple by a multi-meter. Measure the voltage developed at the junction. $1 \text{ mV} = 25^\circ\text{C}$. Designed in TDC. Flame temperature of a spirit lamp is about 750°C .

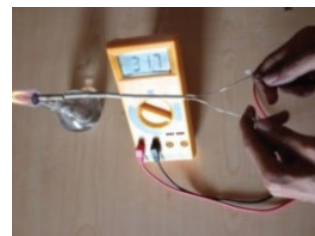
**18. Heat Transfer by Radiation***

Heat radiation (as opposed to hot air - molecules with kinetic energy) is the transfer of internal energy in the form of electromagnetic waves. This experiment demonstrates blue light has higher radiation energy than yellow light. Demo expt. This also confirms heat is light and light is heat.

**19. Temp. coefficient of resistance of a metal***

In this experiment, variation of resistance of a metal with temperature is measured. Plot the graph R vs T . Resistance of a metal increases with increasing temperature. Experiment by TDC.



20. Temperature dependence of resistance of a semiconductor*

We examine the variation of resistance of a semiconductor with temperature. Plot of R vs T of a semiconductor shows decrease in resistance exponentially with increase in temperature. Plot of $\log R$ vs T gives band gap.

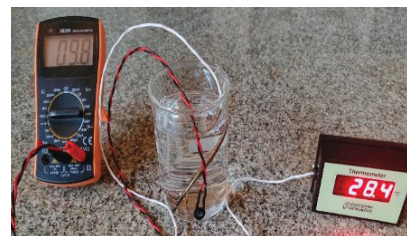

21. Newton's law of cooling*

In this experiment, we verify Newton's law of cooling that how the temperature of liquid varies with surrounding temperature. ΔT Decreases exponentially with time. Just a beaker, timer and temperature measurement by thermocouple is sufficient to show Newton's law of cooling.



22. $PV = nRT$ Pressure Cooker Designed in TDC*

In this experiment, we show how pressure cooker, an application of $PV = nRT$ works. When temperature raised from 300K to 393K, pressure increases from 1 to 1.3 atmosphere.



23. Specific heat of metal*

We determine specific heat of metals by the method of mixtures. Here the calorimeter is a simple glass beaker and it gives good results as compared to classical way of doing.

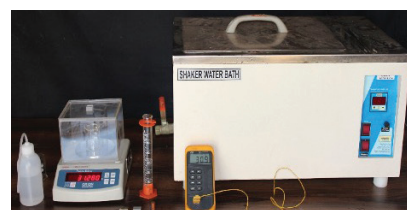

24. Specific heat of liquid*

In this experiment, we measure the specific heat capacity of water – This is also the mechanical equivalent of heat.

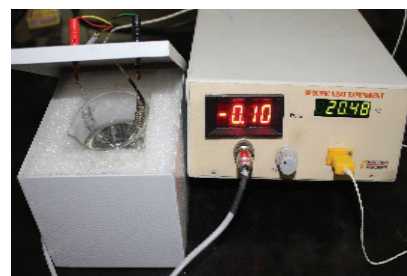

25. Mixing of two liquids of different temperatures*

We determine the temperature of two liquids at different temperature and find the resultant temperature.



26. Latent heat of fusion of ice*

Latent heat of the ice is the heat liberated when ice changes state from solid to liquid.



27. Mapping of magnetic lines of force*

Mapping the Magnetic lines of force of a bar magnet to find its magnetic moment. Each magnetic lines of force have different energy and none of the lines intersect each other.

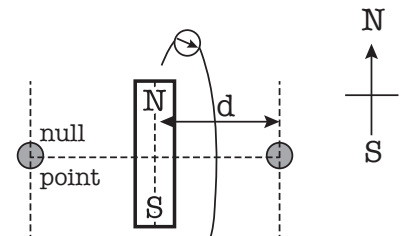

28. Deflection magnetometer

We compare the Magnetic moments of two bar magnets (M_1/M_2) using Deflection Magnetometer (DM).

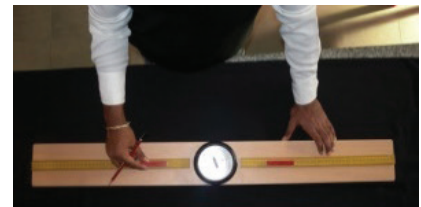

29. Determination of Earth's magnetic field - Tangent galvanometer*

Determination of Horizontal component of Earth's magnetic field BH at a place using tangent galvanometer. Here we introduced constant current power supply and made this experiment simple. Experiment simplified in TDC.



30. Laws of reflection*

We verify that the incident light, reflected light and normal line at the point of incident ray all lie in the same plane. The angle of incidence (i) is equal to the angle of reflection (r), that is, $\angle i = \angle r$. Simple plane mirror and pins are only needed to prove these two laws of reflection.

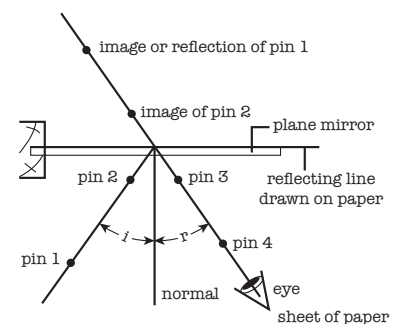

31. Laws of refraction and determination of lateral shift, Snell's law*

The two laws of refraction verified by glass slab to find the lateral shift of a light ray when passing through a glass slab. The refractive index of the flint glass is determined by the Snell's law. We provide better glass block to do proper experiments to get good value of refractive index.

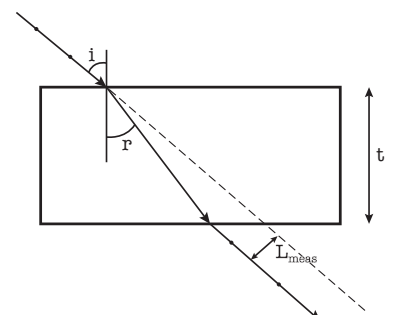

32. Determination of refractive index of a prism – Pin method

In this experiment, we find the refractive index of the prism by finding the angle of minimum deviation from graph. Different types of prisms are used to determine the refractive index.

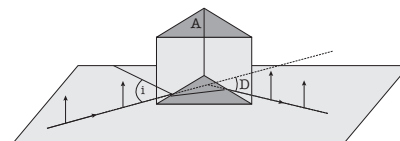

33. To determine the refractive index of a liquid – Shift method

In this experiment, we determine the refractive index of a liquid by shift method using a traveling microscope by measuring apparent depth of the object in liquid.



34. Determination of focal length of lens*

We determine the focal lengths of convex lens using distant object method and u-v method. Newly designed optical bench is introduced in this experiment. Here we find the power of lens also. The instrument is better designed than the crude method followed.

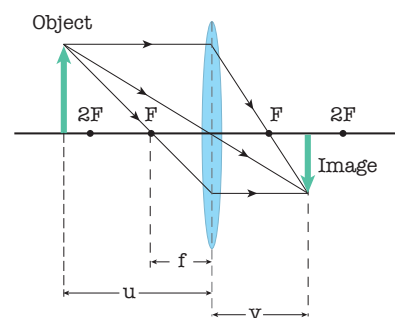

35. Determination of focal length of concave lens using convex lens – Combination and separation method*

Determine the focal length of the concave lens using convex lens. A good combination of concave and convex lens is used in this experiment.

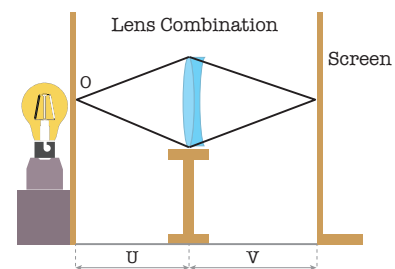

36. Focal length of concave mirror*

In this experiment, we find the focal length of concave mirror using distance object method and u-v method.

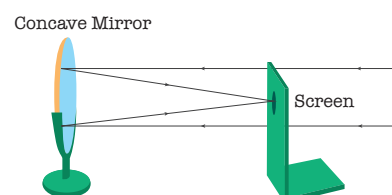
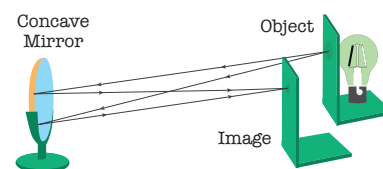

37. Determination of wavelength of light – Diffraction through grating*

Determining the wave-length of laser light using different value grating plate. As light enter the grating plate it bends that make diffraction.

$$m\lambda = d\sin \theta_m$$



38. Velocity of light in water*

This experiment shows how the wavelength value of light changes from air to liquid. Diffraction of light in air and water is compared.

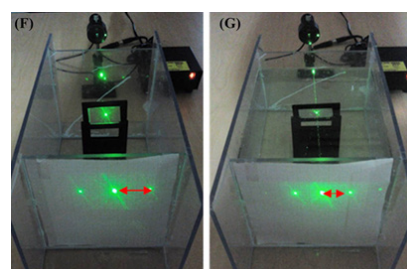

39. Energy of a photon*

We observe the dispersion of light to determine the wavelength of different colours of light using digital spectrometer and calculate the energy of a photon associated with them. Excellent expt. designed in TDC. This is a hit experiment liked by all the teachers at all levels.



40. H₂ Lamp – Hydrogen emission spectra

In this experiment, we measure the wavelength of the Balmer line from the hydrogen lamp and find the energy of red light of hydrogen emission spectrum = 1.89 eV, Verifying Bohr's theory of light emission from H atom.



41. Multimeter*

Multimeter can be used to measure multi functions such as voltage, current and resistance. It has different ranges in each function.

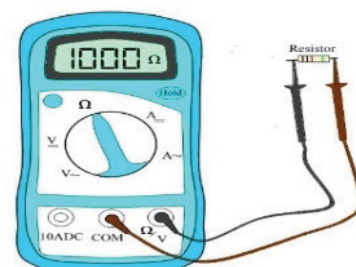

42. Determination of equivalent resistance – Series and parallel circuits*

The total resistance of parallel and series connection circuits using carbon resistors and multimeter. Simple way of finding the total resistance in series and parallel circuits is done here.

$$R_s = (R_1 + R_2) \Omega$$

$$R_p = \frac{R_1 \times R_2}{R_1 + R_2} \Omega$$

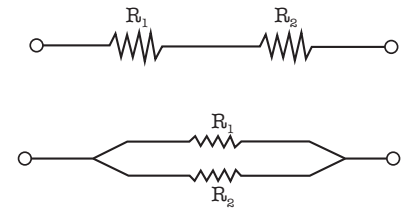

43. Electric charge +ve and -ve*

In this experiment, we verify the generation of electric charges by rubbing a straw to tissue paper. Easiest way to demonstrate like charges repel and unlike charges attract.

44. Verification of Ohm's law*

Verify that the current flowing through a conductor is proportional to potential difference across it. From this experiment Ohm's can be verified.

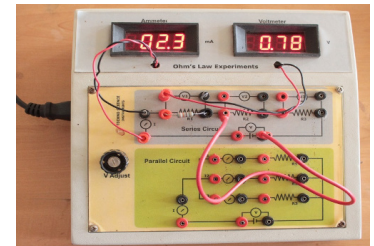

45. Resistivity of metal – Meter bridge*

Find the resistance and resistivity of different metals using Meter Bridge based on Wheatstone principle. Experiment gives accurate values of resistivity of metals including Cu. The experimental kit is modified by TDC to get accurate values.

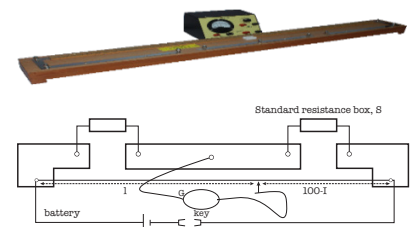

46. Diode characteristics*

In this experiment, we draw the forward and reverse bias characteristics of rectifier diode and determine the knee voltage and forward bias resistance using a simplified circuit.



47. Zener diode characteristics*

Determine the forward and reverse bias characteristic of a Zener diode and determine the break down voltage by plotting the graph I vs V.

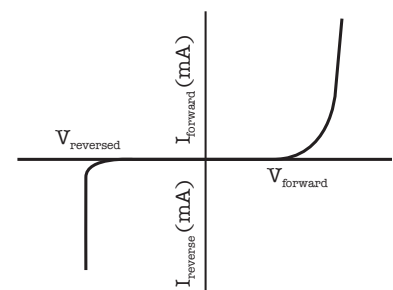

48. Light emitting diode (LED) characteristics*

We find the voltage for different colour LEDs. From this experiment we verify the $E = h\nu$ (J). For Red LED 1.9 eV, for green LED 2.1 eV, green LED 2.2 eV and for blue LED 2.8 eV.

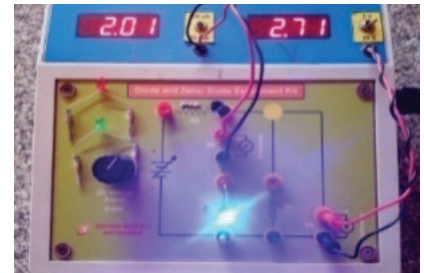

49. To study Half wave and Full wave rectifier circuits*

Construct the circuit, measure Output V_{DC} of a half wave and full wave rectifier circuit. We observe the output waveform on a CRO.

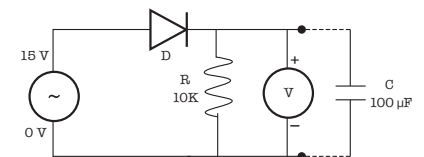
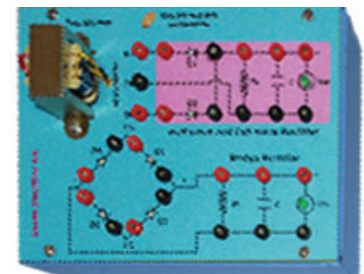

50. Transistor characteristics*

In this experiment, we study the input and output characteristic of a given transistor and determine the α and β , the dc current gain. This experiment kit is highly appreciated by the teachers.

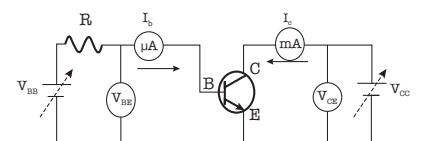

51. Determination of Planck's constant – Photoelectric effect

We determine the Planck's constant using different filters. By plotting a graph of frequency vs stopping potential, we can find Planck's constant and work function of photosensitive metal.

Most of the experiments are designed and developed, fabricated initially in the TDC. Later, M/S Techno Science Instruments refined and produced the equipment. Now they are selling under a joint logo to the schools.

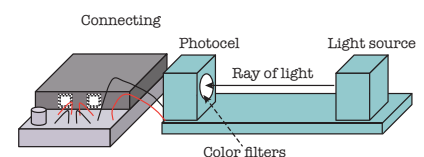

HIGH SCHOOL CHEMISTRY EXPERIMENTS

Over 60 experiments designed here in TDC are performed by the teachers during the training. All of them can be performed in the class room during the science period.

1. Percentage of oxygen in atmosphere*

Atmosphere contains 21% Oxygen in air, which can be measured in this experiment. Burning candle is kept on a tray containing water. Cover the candle with inverted glass tube and observe rise in the water level. Rise in level is about 1/5 of cylinder height. An experiment at 8th class.

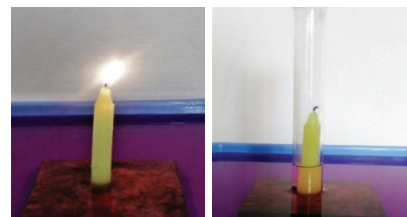

2. Measurement of temperature*

Experiment is to measure the temperature of ice, water, spirit lamp flame, LPG flame using mercury thermometer and thermocouple up to 1000°C.



3. How elements are discovered?*

Flame test is a procedure to detect the presence of elements, primarily metal ions, based on characteristic emission of coloured light. Example, LiCl dissolved in ethanol used in the spirit lamp. Number of colours from different elements are demonstrated. Colours from elements excite the students. Colours from many salts are shown to the teachers.



4. Electronic configuration and orbitals*

This is a powerful demonstration/experiment on Aufbau principle and energy levels of different orbitals. Electrons in atoms are occupied in 1s, 2s, 2p, 3s, 3p, 4s, 3d, 4p, 5s, 4d, 5p, 6s, 5d, 4f, 6p in this order as the number of electrons (= Z, atomic number) increases. Model explains electronic configuration of atoms in its ground state.



5. Preparation of carbon dioxide

Carbon dioxide is prepared by the reaction of CaCO₃ with 1:1 HCl. CO₂ can be confirmed by passing the gas through lime water which leads to precipitation.



Study other chemical properties.



6. Carbon dioxide – water reaction

Our exhale contains carbon dioxide. When we blow our breath to the alkaline solution mixed with phenolphthalein indicator, the colour changes due to formation of acidic medium. Colour changes from pink to light yellow. On heating CO_2 goes away giving pink colour back.

7. Preparation of Sulphur dioxide

SO_2 is prepared by heating copper turnings with conc. H_2SO_4 . Apparatus is same as in expt. 5.



Gas collected is used to test the properties of SO_2 .

**8. Preparation of chlorine**

When MnO_2 reacts with conc. HCl and it gives chlorine gas. Same apparatus can be used.



Test the properties of Cl_2 .

**9. Preparation of PCl_5**

PCl_5 can be prepared by reaction of red phosphorous with chlorine gas.

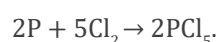

Drop P powder into a glass tube with Cl_2 . P burns. This experiment should be done carefully.

**10. Preparation of oxides of nitrogen**

When Cu react with 1:1 HNO_3 , gives colourless NO gas.

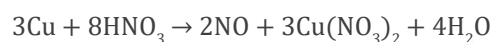

Similarly, copper turnings react with conc. Nitric acid to liberate brown NO_2 gas.

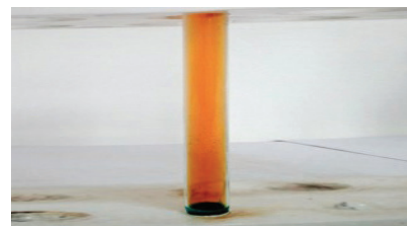
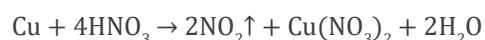
**11. Reaction of metals with mineral acids**

When Zn metal reacts with dil. HCl , liberates hydrogen gas.

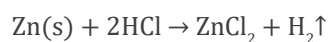

Test hydrogen by pop test. Similarly, Fe, Al, Mg also react with HCl to give hydrogen.



12. Reaction of CaO with HCl

When calcium oxide is reacting with HCl, it gives soluble calcium chloride.

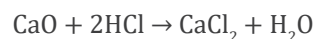
**13. Reactions of NaOH with Al**

Al reacts with alkali such as NaOH to give hydrogen and sodium aluminate. Test hydrogen by pop test.

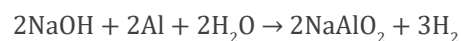
**14. Reaction of metals with water**

When sodium reacts with water gives hydrogen and NaOH.

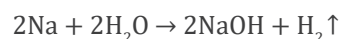
**15. Metal displacement reactions***

This experiment is to study the metal displacement reaction of ZnSO_4 , MgSO_4 and CuSO_4 with respective metals on a spot plate.

**16. Exothermic metal displacement reactions**

This experiment reinforces ideas about **energy changes** during reactions, the **reactivity series** of the metals and the chemical behaviour of metals by measuring the temperature rise.

17. Reaction between Iron nail and CuSO_4 solution

When shining iron nail is dipped in copper sulphate solution for longer time, Cu deposits on the iron nail as a result of metal displacement reaction.

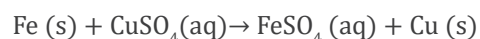
**18. Separation of miscible liquids**

Distillation is a process in which two liquids which are miscible with each other can be separated into its component fractions. This is achieved by making use of difference in the boiling points of the two liquids. The liquid having lower boiling point evaporates more than the one having a higher boiling point. The vapor is then condensed back into liquid form and collected.

19. Distillation of saline water

Water which contains dissolved salts can be purified by distillation. The dissolved salts being non-volatile remain in the flask while pure water distils over.



20. Burning of magnesium ribbon in air

When Mg ribbon is burnt in air, it gives MgO. When MgO is dissolved in water, it forms basic solution $Mg(OH)_2$. Test the base with red litmus paper which turns its colour to blue.



21. Combustion

Heat is generated by burning fuels like kerosene lamp, match stick, candle, and spirit lamp. Observe both heat and light when you burn a fuel. This is a demonstration experiment. Collection of locally available fuels, their names, and cost is the part of the activity.



22. LED Continuity test*

This is the experiment to distinguish electrolyte and non-electrolyte by using LED continuity circuit. Light glows if it is electrolyte.

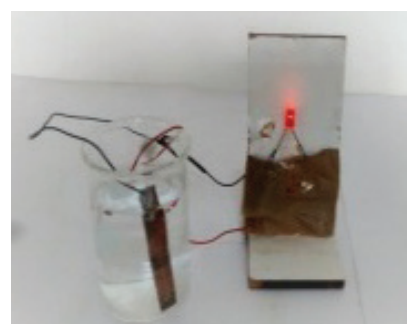

23. Conductivity measurement

Using conductivity meter it is possible to measure conductance of a solution. Based on conductivity value, one can distinguish electrolyte and non-electrolyte. RO water – How good can it is shown.



24. States of matter

Materials are classified into solids, liquids and gases. Simplest way to show these three states of matter is by taking ice to water to vapor. Water vapor consists of nano particles of water cluster which can be seen by Tyndall effect.

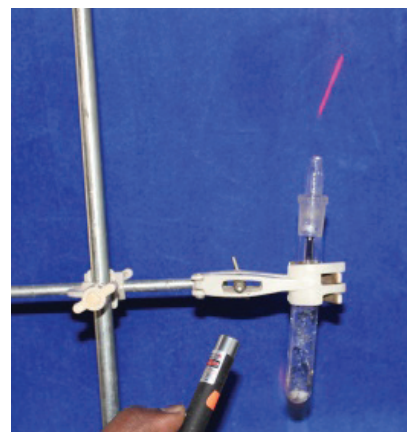
**25. Sublimation of solids**

By heating solid ammonium chloride or iodine it directly goes to vapor phase. Camphor and naphthalene also show similar results. In the image, iodine is taken in a china dish and covered with inverted funnel. When it is heated, iodine sublimes and collected at cooler part of the funnel.

**26. What is iodised salt?**

Iodised salt is a common salt which is sprayed with potassium iodate. This can be tested by adding starch solution and lemon juice giving blue colour - a standard iodine test.

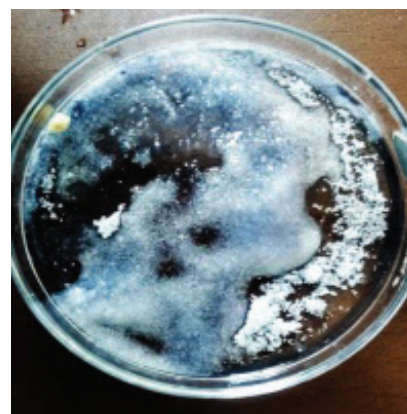
**27. Double displacement reactions**

When solutions of sodium sulphate and barium chloride are mixed, a double displacement reaction occurs. One of the products, barium sulphate precipitates out since it is insoluble in water.

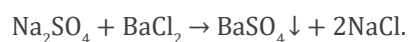

More such reactions are tried by the teacher.

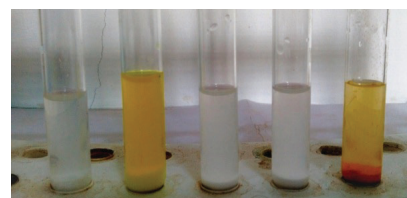

28. Colloids and Tyndall effect

Passing the laser light through dilute milk and observing the scattering is called as Tyndall effect. Light is scattered by colloids.

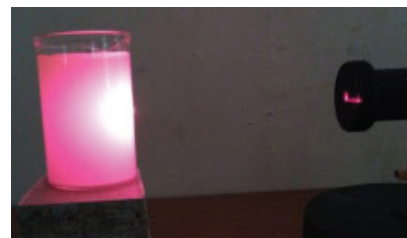

29. Preparation of a solution of known composition

Salt such as NaCl is called as solute which dissolves in water. Water is a solvent. Simple way of expressing the concentration of a solution is by mass percentage.

$$\text{Percentage by mass of solute} = \frac{\text{Mass of solute} \times 100}{\text{Total mass of solution}}$$



30. Solubility of common salt

A saturated solution at room temperature is formed when no more solute can be dissolved in the solvent at room temperature. When known volume of saturated solution is dried, (mass of solid/mass of water) x100 gives percentage solubility.



31. Separation of two immiscible liquids

When two liquids which are immiscible with each other are mixed, they form two different layers, depending on their density. The lighter liquid forms the top layer and the heavier the bottom layer. These two can be physically separated by using a separating funnel.

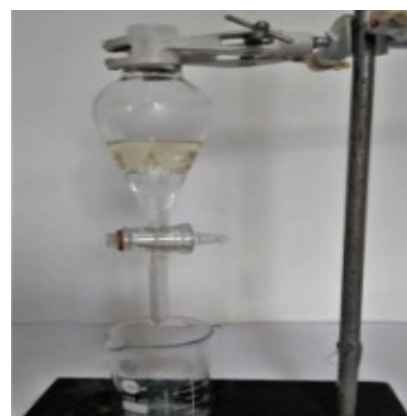

32. Growing crystals

Bigger crystals are prepared by slow evaporation of solvent from saturated solution. Saturated solutions are made in hot water. But with a seed crystal, it is possible to get much larger and better-shaped crystals. See Copper sulphate crystal. You can grow NaCl. If possible, see how common salt is made from sea water.

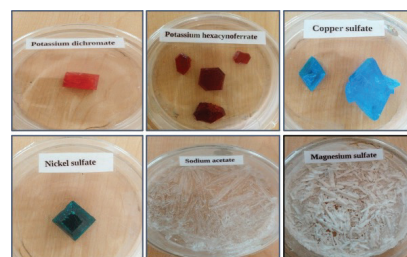

33. Purification of salt by recrystallisation

Solution of red coloured sea salt is prepared and filtered. Filtrate is collected and evaporated under sunlight. One can observe pure sodium chloride cubic crystal more easily under microscope. Salt becomes pure, white.



Before recrystallization



After recrystallization

34. Mole concept

Number of moles means it is the ratio of mass of the given compound to the molecular or atomic mass unit.

How to find number of moles of NaCl in 5.85 gm NaCl.

Mole = mass of a substance divided by molecular mass. Molecular mass of NaCl = 23 + 35.5 = 58.5. Therefore, no of moles in 5.8 gm = $5.8/58.5 = 0.1$ mole. This is a difficult concept and with a weighing balance, one can learn by measurement. Many more examples can be shown in 15 min.

**35. Determination of Avogadro number**

This is a hit – high impact experiment in TDC.

A known quantity of electricity is passed through copper sulphate solution using copper plate as anode and stainless steel as cathode. The mass of copper deposited is proportional to the quantity of electricity/charge passed. So how many charges for one equivalent mass of Cu gives N. Constant current source designed in TDC is the key for success of this experiment. Accurate value is always obtained.

**36. Metal oxides and non-metal oxides**

When metal and non-metal burn in air, those form metal oxide and non-metal oxide respectively. But when these oxides dissolved in water it shows different character.

Metal oxide + water → Basic solution

Non-metal oxide + water → Acidic solution

Burn metals and non-metals such as Mg and S and study the properties.

37. Preparation of oxygen by decomposition of KMnO_4

When KMnO_4 is heated, it decomposes and gives oxygen.



Lighted agarabatti (INCENSE STICK) catches fire.

38. Catalytic decomposition of KClO_3

When KClO_3 is heated on a test tube, it only melts and no oxygen comes out. Add a small amount of MnO_2 plenty of oxygen comes out. Study of a catalytic reaction. Lighted INCENSE STICK catches fire.

39. Decomposition of Lead nitrate

When lead nitrate is heated, it decomposes and lead oxide with the evolution of NO_2 and O_2 . Similarly, copper nitrate also decomposes to give NO_2 and O_2 . This not preferable to do because lead is a pollutant.



40. Reduction of CuO by carbon to Cu

Copper oxide can be reduced to copper metal by heating CuO + charcoal powder in a test tube on a spirit lamp. Formation of Cu metal can be confirmed by the reaction with conc. HNO_3 .

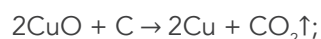

CuO with HNO_3 does not give NO_2 ; repeat experiment with Cu turnings.



41. Electrolysis of water

Electrolysis cell consists of two Ni electrodes. The cell is filled with 30% KOH in water. When a minimum voltage of 2 to 3 V is applied, water starts splitting and hydrogen is evolved at -ve electrode (cathode) and oxygen at +ve electrode (anode).

42. Comparison of reactivity of HCl and CH_3COOH

Ethanoic acid will be tested with full-range universal indicator solution, Mg metal, NaOH solution and Na_2CO_3 solution. These reactions will be compared with those of hydrochloric acid of same concentration, to show that ethanoic acid is a weak acid.

43. Measurement of pH of different solutions

A paper impregnated with a Universal Indicator is used to approximately measure the pH of a solution. The pH paper changes colour according to pH value.

Using pH meter, it is possible to measure the pH of a solution with accurate values between 0 to 14.

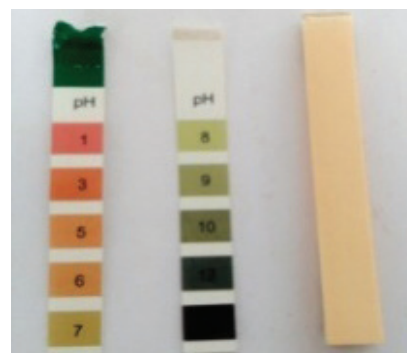

44. Exothermic and Endothermic reactions

Reaction between an acid and a base, rusting of iron are examples of exothermic reactions. Melting of ice, mixing ammonium nitrate and water are some of the endothermic reactions.



45. Determination water of crystallisation and formula of a hydrated salt

In this experiment, a known mass of hydrated **copper (II) sulphate** is heated to remove the **water of crystallisation**. The mass of water is found by weighing before and after heating. This information is used to find x in the **formula** $\text{CuSO}_4 \cdot x\text{H}_2\text{O}$.



46. Bleaching action of bleaching powder

Bleaching powder can be represented as calcium oxychloride, $\text{Ca}(\text{OCl})_2$. With dilute sulphuric acid, hypochlorous acid is released; hypochlorous acid generates nascent oxygen which is responsible for bleaching action.

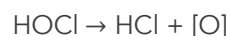

47. Oxidation of alcohols by $\text{K}_2\text{Cr}_2\text{O}_7$

Ethanol can be oxidised into corresponding carboxylic acid i.e., ethanoic acid by using $\text{K}_2\text{Cr}_2\text{O}_7$. Colour of dichromate changes from orange to green due to change in the oxidation state of the chromium in the reaction.

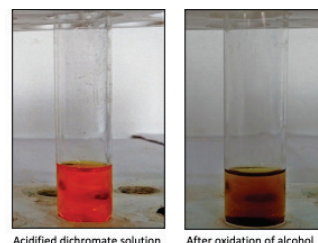

48. Esterification reaction

Ester is produced by the reaction of any alcohols with any carboxylic acid in presence of conc. H_2SO_4 . Ester can be identified with its fruity odour.

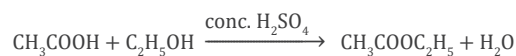

49. Daniel cell

Daniel cell is the simplest voltaic or galvanic cell. It converts chemical energy into electrical energy spontaneously. For Cu and Zn system, voltage will be 1.1 V.

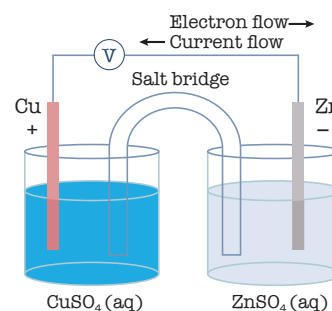

50. Tincture Iodine

The solution of iodine in ethanol is called as Tincture. Tincture is an antiseptic which is moderately toxic. The tincture is primarily used as disinfectant.

51. Reaction for unsaturated compounds – Organic addition reaction

Organic addition reaction is preliminary reaction for the testing of any unsaturated compounds. When Br_2 water reacts with cyclohexene, we observe decolourisation of Br_2 water.

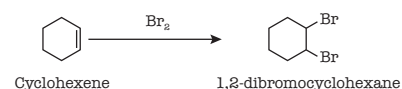
**52. pH of red and black soil**

Take the soil, put in water and use pH paper to test acidic or basic soil.

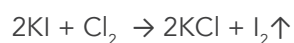
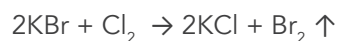
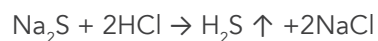
53. Displacement of Iodine from iodide by chlorine**54. Displacement of Bromine from bromide by chlorine****55. Preparation of H_2S and its properties.****56. Corrosion of Fe in acid vapor**

This is a complex reaction. Fe in acidic medium reacts with H_2O from atmosphere to give reddish oxy hydroxide which is called rust.

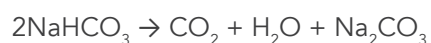
57. Decomposition of baking powder

58. Boiling point of water and oil

Here we show how to determine boiling point of liquids using boiling tube.

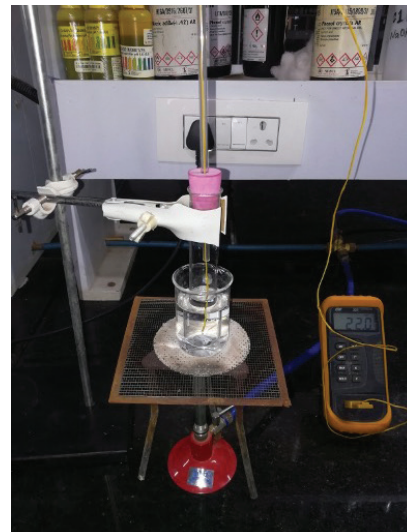
**59. Melting point of camphor**

Here we show how to determine melting point of solids using digital melting point apparatus.

**60. What is Rock salt?
Why Jaljeera drink smells?**

Rock salt is a NaCl mineral containing FeS in it. When dissolved in water, H₂S smell comes out. This salt is added in Jaljeera drink.

61. Estimation of acid by titration

Here we introduce pipette, burette and accurate measurement of volume.

HIGH SCHOOL BIOLOGY EXPERIMENTS

Over 50 biology experiments are designed and the teachers perform them during the training. Of special importance is the introduction of binocular microscope of 1000 magnification. Large number of experiments depend on microscopic observation. Isolation of bacteria, growth of bacteria, safety measures, isolation of DNA, fingerprinting of DNA by electrophoresis which are all there in their books which have been brought into practice.

1. Microbiological Tools

Petri plates used to culture microorganisms. Inoculation loop used to transfer bacteria into the medium. Inoculation needle used to transfer fungi and L-shaped rod used to spread the inoculum on solid medium. Several tools are introduced.



2. Binocular Compound Microscope

The compound microscope uses lenses and light to enlarge the image. It is also called an optical or light microscope. The **compound microscope** has two systems of lenses for greater magnification, 1) the ocular or eyepiece lens that the observer looks into and 2) the objective lens, the one closer to the object. The total magnification in this microscope will be 1000x.

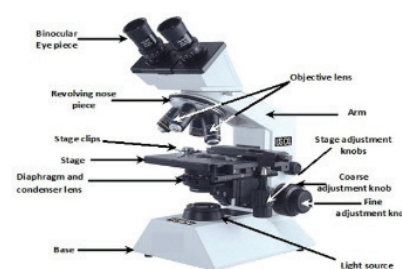

3. Microbiological Sterilisation Method

Sterilisation is a process of complete physical elimination or inactivation of all living cells in an environment. There are different methods of sterilisation.

1. Heat sterilisation: Flame, Dry heat and moist heat sterilisation.
2. Chemical sterilisation,
3. Filter and
4. Radiation sterilisation

4. Preparation of Culture Media

Microorganisms require basic nutrients (Carbon and Nitrogen) for their sustenance of life and reproduction. The food material on which microorganisms are grown in a laboratory is known as Culture medium. Basically, there are two types of media: solid medium and liquid medium. In general, Nutrient Agar used for growing bacterial culture and Potato Dextrose Agar used for growing fungi culture.

5. Isolation of Microorganisms from Natural Sources

Microorganisms are everywhere in nature. They are present in soil, water and air. Soil and aquatic habitat serves as chief source of nutrients for various microbes including bacteria, fungi, protozoans, etc. When the sample from such sources is directly inoculated on to a nutrient medium, microorganisms multiply rapidly and direct plating is a simple technique to isolate microorganisms from different natural sources.



6. Culturing of Bacteria in Liquid and Solid Media

On solid medium bacteria multiply and form a distinct colony whereas in liquid or broth medium it forms a suspension. For colony characteristic and for isolation solid media are used. For extracellular metabolites and for cells to be pelleted out liquid medium is used.

7. Study of Colony Characteristics of Bacteria

The cultural characteristics of an organism pertain to its macroscopic appearance on a medium. The colony morphology of an organism depends on type of media used and other growth conditions provided. Descriptive terms must be used in recording cultural characteristics as shown in the figure.

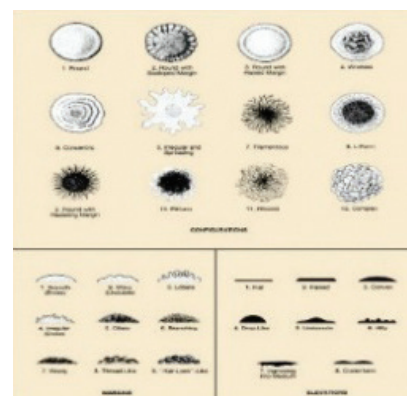

8. Bacterial Catalase Test

Most aerobes and facultative anaerobes utilise oxygen for respiration and produce hydrogen peroxide as a metabolic product. The hydrogen peroxide produced is toxic to the cells and hence production of H_2O_2 becomes suicidal. Bacteria have evolved a mechanism of getting rid-off H_2O_2 produced in the cell. The bacteria produce catalase to breakdown H_2O_2 into water and oxygen.



9. KOH Solubility Test

This test is essential for differentiating bacteria into two broad groups: Gram positive and Gram negative. This is an alternative test for Gram's staining. Gram negative bacteria will have excess of lipids and when such cells react with alkali results in viscid material.

10. Preparation of Bacterial Smear

To study the size, shape, arrangement and structure of bacterial cells, they are first fixed on a glass slide and stained to make them more readily visible. A properly prepared bacterial smear is one which withstands one or more washings during staining without loss of organisms.

11. Simple Staining

The use of single stain to colour bacteria is commonly referred to as simple staining. Some of the most commonly used dyes for simple staining are methylene blue, crystal violet and safranin. All of these dyes work well on bacteria because they have colour bearing ions that are positively charged. The fact that bacteria are slightly negatively charged, this results in attraction between cations and the organism.

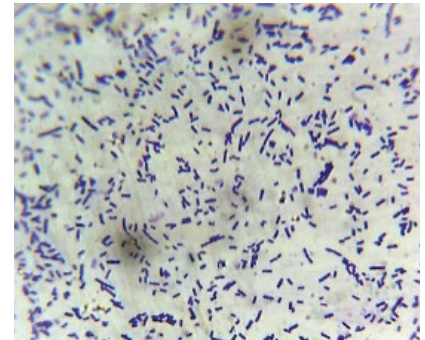

12. Negative Staining

In negative staining technique a simple stain is used that does not stain the bacteria but stains the background. Nigrosine/India ink, an acidic stain carrying negative charge, is repelled by the bacteria which too carry a negative charge on their surface. Therefore, bacteria cell appears transparent and unstained upon examination. Negative staining provides information about the cell shape and arrangement.



13. Gram's Staining

The Gram's staining method is named after the Danish bacteriologist **Hans Christian Gram** who originally designed it in 1884. Gram staining is a differential staining method of differentiating bacteria into two large fundamental groups; Gram-positive and Gram-negative, based on the chemical and physical properties of their cell walls.

14. Bacterial Motility – Hanging Drop Technique

Hanging drop preparation is useful for microscopic examination of living microorganisms to study their motility. Organisms are observed in a drop that is suspended under a cover glass in a cavity slide. Since the drop lies within an enclosed glass chamber, drying occurs very slowly.

15. Isolation of Seed Borne Fungi by Blotter Method

Fungi are major pathogens of plants. They are transmitted through seed both externally and internally. In this method, when moisture is provided to seed, they imbibe water. The fungi present in and on it get expressed as seed itself acts as nutrient source. This technique is simple and easy to perform.

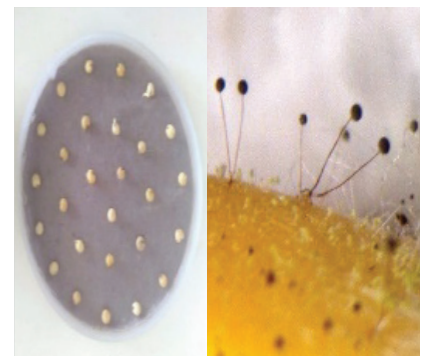

16. Microscopic Observations of Fungi by Tease Mount Preparation

In this technique, fungi are stained using cotton blue stain and mounted in lactophenol to obtain semipermanent microscopic slides. Many of the fungi are themselves coloured known as 'Dematiaceous fungi', which can be mounted using lactophenol solution and observed using a microscope without staining. The tease mount preparation provides a chance for different conidia and hyphae to be observed.

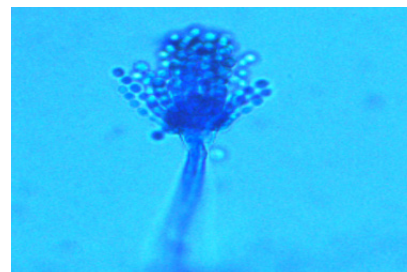

17. Examination of Pond Water Microorganisms

Pond is an important aquatic ecosystem consisting of various microorganisms such as bacteria, fungi, algae and protozoa. Microscopic examination of a drop of pond water through wet mount preparation provides considerable amount of information on different types of microorganisms and their shape, colour and motility.

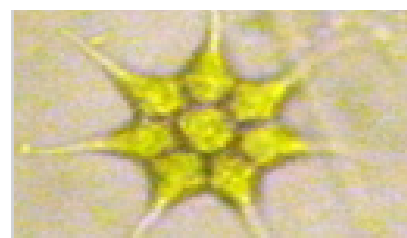

18. Study of Cyanobacteria/Algae

Cyanobacteria and algae are groups of microscopic unicellular or multicellular organisms which are present abundantly in most of the aquatic ecosystems. Some of them are also seen on barks of trees and in soil. They consist of photosynthetic pigments and produce their own food. Algae are eukaryotic organisms that have distinct, visible nuclei and chloroplasts. The undifferentiated algal structure is referred as a **Thallus**. Although referred as blue green algae, cyanobacteria are prokaryotic microbes. Cyanobacteria are gram negative bacteria consisting of photosynthetic pigments in granules that are attached to the membrane.

19. Study of Fungi

Fungi are eukaryotic microorganisms without plastids. Fungi are unicellular or filamentous consisting of multicellular haploid hyphae with absorptive nutrition. Their cell wall is made up of chitin or β -glucans. The estimated number of fungi is 1.5 million among which only 70,000 species are known till date. Fungi are morphologically diverse group of organisms.

20. Study of Lichens

Lichen is the term used to describe symbiotic, mutualistic interaction between fungus and algae/cyanobacteria. They grow on rocks and tree barks. The colour of lichens may vary from white to black through red orange yellow and green. Morphologically, lichens are made up of an algal layer sandwiched between two fungal layers.

21. Study of Protozoa

Protozoa are eukaryotic, generally unicellular life forms which lack cell wall and are motile at some stage of their life cycle. The locomotive organelles of protozoa are pseudopodia, cilia or flagella. Protozoan members are free-living or parasitic in animals. They generally feed upon bacteria and other protozoans. There are some 65,000 species of protozoan members known till date; few of them such as *Entamoeba histolytica*, *Plasmodium* spp.

22. Effectiveness of Hand Scrubbing on Microbial Load

Human skin harbours various microorganisms. Some pathogenic microorganisms may also persist and transmit through contaminated hands. Various methods like washing with water and soap, swabbing with alcohol are practiced. Scrubbing the hands involves the physical removal of microbes. They can be killed using suitable antiseptics such as 70% alcohol or Dettol.

23. Antibiotic Sensitivity Test

Antibacterial agents are chemicals that can kill or inhibit the growth of bacteria termed as bactericidal or bacteriostatic compounds respectively. When the discs impregnated with antibacterial agents come in close contact with the medium, they get diffused into the medium thus inhibiting the growth of bacteria.

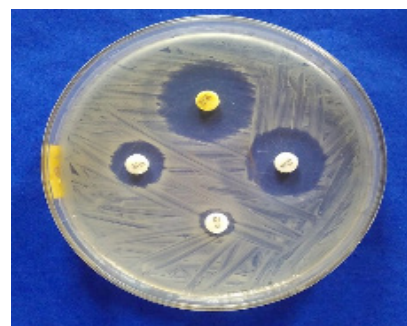

24. Biofertilizers/ Biopesticides

Use of biofertilizers is one of the important components of integrated nutrient management. They are cost effective and renewable source of plant nutrients in sustainable agriculture. Several microorganisms are being exploited in the production of biofertilizers. Many biofertilizers are commercially available in the market such as *Rhizobium*, *Azotobacter*, *Azospirillum*, *Azolla*, *Bacillus megaterium*, etc. Some organisms like *Trichoderma*, *Pseudomonas*, *Bacillus* sp. and others can kill pathogenic organisms, and hence used as biopesticides.

25. Ammonification in Soil

The nitrogen in most plants and animals exists in the form of protein. When animals and plant die, the protein is broken down to amino acids, which in turn are delaminated to liberate ammonia. The process of production of ammonia from organic compounds is called ammonification. Ammonification is one of the important steps in the nitrogen cycle. The presence of ammonia is detected by the formation of brown coloured precipitate after addition of Nessler's reagent.

26. Study of Plant Diseases

Agrios (1997) has defined plant disease as a series of invisible and visible responses of plant cells and tissue to a pathogenic microorganisms or environmental factors that result in adverse changes in the form, function or integrity of the plant and may lead to partial impairment or death of the plant or its parts. Plant diseases are caused by fungi, bacteria, nematodes, viruses and viroids.

27. Mitosis in Onion Root Tip

Somatic growth in plants and animals takes place by the increase in the number of cells. A cell divides mitotically to form two daughter cells. The ability of cell to divide is called totipotency. In plants, such divisions rapidly take place in meristematic tissues of root and shoot where the stages of mitosis can be easily observed. In animals, mitotically dividing cells can be easily viewed in the bone marrow cells.

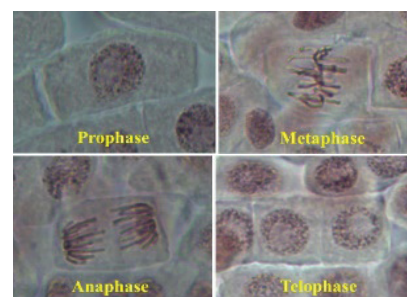
**28. Study of Pollen Germination**

To understand the formation of pollen tube. Take a cavity slide with a drop of 10% sucrose solution. Take fresh *Catharanthus roseus* flower and remove the petals and open the anther portion of flower. Tap the anther portion in the cavity of the slide, which contain sucrose solution and carefully place the cover slip on it. Observe the slides in every 5 mins. After 20 min you can clearly observe the formation of pollen tubes.

**29. Study of Monocot and Dicot Plants (Stem, Roots and Leaves)**

To understand the difference between the monocot and dicot plants based on the cross section of stem, root and leaves.



30. Oxygen Liberation During Photosynthesis

To demonstrate the release of oxygen during photosynthesis by inverted funnel method.

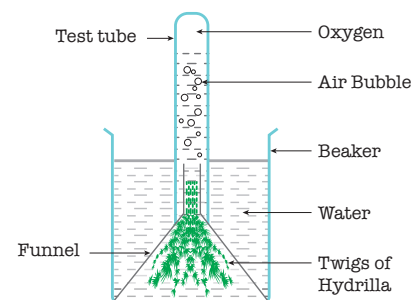

31. Determination of Respiratory Quotient By Ganong's Respirometer

The substances oxidised during respiration are called respiratory substrates e.g. carbohydrates, fats, proteins etc. The respiratory quotient (RQ) value is the ratio between the volume of carbon dioxide given out and the volume of oxygen absorbed by a given weight of tissue in a given period of time. The RQ for different substrates varies.

32. Transpiration Pull

Transpiration is a process of loss of water vapours from aerial parts of the plant. It takes place mainly through stomata. This helps in uptake of water through conducting tissues like xylem. This process is the basic requirement for uptake of water by roots. Transpiration stream is flow of water through plant as a result of loss of water during transpiration.

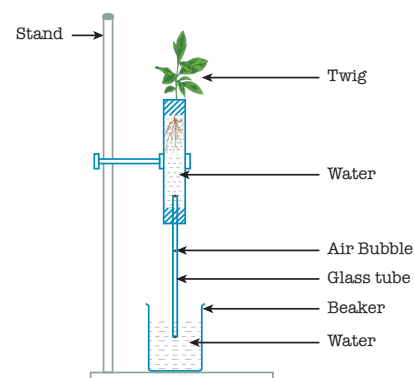

33. Determination of Transpiration by Ganong's Potometer

Transpiration is the loss of water in the form of water vapor through the aerial parts of the plants especially through the leaves. In all green plant's transpiration occurs mostly through the stomata of the leaves. The rate of transpiration depends upon various climatic factors like intensity of sunlight, temperature, humidity, velocity of wind, atmospheric pressure, availability of water to the plant etc. Potometers are the instruments used to measure the rate of transpiration in a cut twig under laboratory conditions in a plant.

34. Study of Seed Germination

Germination refers to production proper root and shoot which makes the plant to become normal under field conditions. This is an important test in seed testing station.

35. Study of Inflorescence

An inflorescence is defined as a group or collection of flowers. In many cases, the individual flowers are inconspicuous and by themselves will not be able to attract the attention of pollinating agents. Under such circumstances they group together and form clusters called inflorescence. Based on the growth and pattern of arrangement of flower, inflorescences are categorised into various groups.

36. Microscopic observation of Starch Granules

Starch is the main form of storage carbohydrates in plants. It occurs as semi-crystalline granules composed of two polymers of amylose and amylopectin. There is enormous variation in granule size and shape between plant species. All types of starch have the same physical and chemical properties but under microscope the granules have different sizes and shapes.

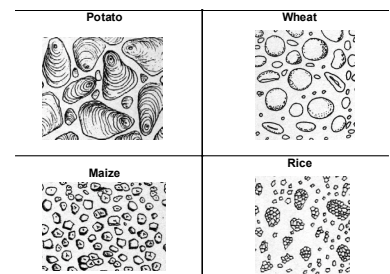

37. Flower Morphology and Floral Diagrams

A flower is the reproductive unit in the angiospermic plants. It is meant for sexual reproduction. A typical flower has four different kinds of whorls namely calyx, corolla, androecium and gynoecium. They are arranged successively on the swollen end of the pedicel called thalamus or receptacle. Calyx and corolla are accessory organs, while androecium and gynoecium are reproductive organs. A flower having either one of those is called unisexual flower.



38. Seed Viability Testing

Germination in seeds occurs if the seed is viable. The seed may look healthy without viability. The seeds without viability cannot be used for sowing purpose but can only be used for consumption. Hence, it is important to test the viability of seeds. This will be helpful in agriculture. All viable cells in the seed are able to show respiration. The embryo present in the cell must be viable. Hence, a biochemical test is designed to test the viability.

39. Effect of Sunlight on Chlorophyll and Plant Growth Hormone Synthesis

Conversion of proplast into chloroplast requires light. If sufficient light is not available plants become yellow, the process is called etiolation. The process of chloroplast development and accumulation of chlorophyll is light dependent. The amount of chlorophyll is directly proportional to the light intensity and duration.



40. Determination of Protease Activity

Papain from latex of papaya and bromelain from the pineapple, are best protease enzymes from plant source. Hydrolysis of protein takes place through protease enzyme. Easily accessible source of enzyme is from fresh pineapple. Gelatin may be used as substrate for protease. Gelatin is solid below 25°C and gets liquefied at higher temperature.

41. Detection of Food Adulteration

Food adulteration is a serious problem for the human health. Various hazardous chemicals/materials are adulterated into food products. This not only causes health problems but also responsible for economic loss for the consumers. Hence, food analysis is essential to detect the adulterants.

42. Blood Group Determination

The procedure for blood typing was developed by Carl Landsteiner (1900). The human blood types can be separated into four basic groups on the basis of two antigens that are present on the red blood cells. These antigens are designated as 'A' and 'B'. ABO typing of blood is based on the principal of agglutination, a type of reaction that occurs between particulate antigen and specific antibodies that leads to clumping of red blood cells. All the teachers test their blood group.

**43. Rapid Quality Testing of Milk**

There are different methods for milk testing that can easily be performed in the farm. Organoleptic test is a rapid platform test performed to determine the quality of milk. The simplest, most cost-effective test is the visual observation, smell and taste. These tests are performed using the human senses thus known as 'Organoleptic tests.

44. Differential WBC Count

To determine the count of different types of white blood cells in the blood sample

45. Qualitative Test for Carbohydrate, Protein and Lipid

To test the presence of carbohydrate, protein and lipid in the given sample.

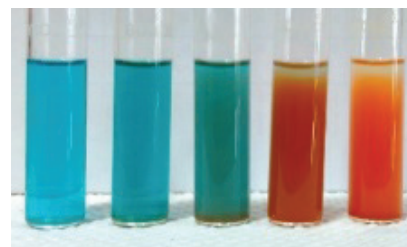

46. Urine Analysis – Strip Method

Normal urine contains only traces of protein. When it is found in urine, usually albumin predominates. Bence-Jones protein, haemoglobin are the significant non- albumin proteins under certain conditions. Minimal proteinuria (less than 0.5g/day) is found following exercise or in highly concentrated urine. The presence or absence of sugar/protein in urine indicates health of an individual.

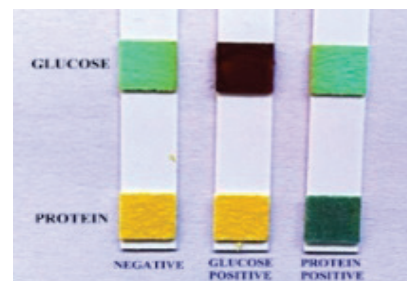

47. Determination of Amylase Activity

Every enzyme has maximum activity at optimum temperature and pH. This is unique to every enzyme. Optimum condition for amylase enzyme is pH 7.0 and temperature is around 37°C. Conversion of starch into maltose and glucose can be tested by Benedict's test as starch is a non-reducing sugar, whereas both maltose and glucose are reducing sugars.

48. Pregnancy Detection

Human chorionic gonadotrophin (hCG) is the hormone produced exclusively in pregnant women after 24hrs of conceiving, the presence of low level of hormone in urine can be detected by sensitive immune chromatography technique. This test indicates the **presence hCG** in urine based on antigen-antibody reaction and thus detects pregnancy.

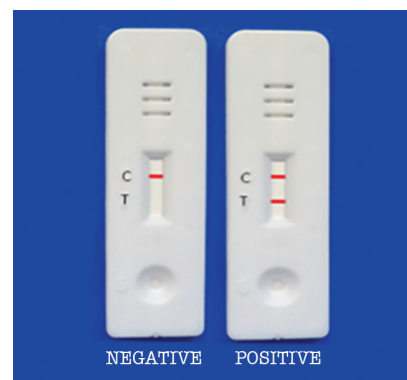

49. Isolation of DNA from Coconut Endosperm/Pea/ Onion

Plant cells are surrounded by cell wall. Treatment with detergent (Sodium dodecyl sulfate, SDS) is an effective way of break opening the cells and their nuclei to release the content. For this, lysis buffer containing Tris, EDTA and SDS is used. The DNA is associated with a number of proteins. These can be removed by adding phenol-chloroform and isoamyl alcohol. The phenol is removed by washing the DNA with chloroform. Finally, cold ethanol precipitates out the crude DNA. Saline sodium citrate (SSC) buffer is used to dissolve DNA.

50. DNA Fingerprinting/ Agarose Gel Electrophoresis

Electrophoresis is chromatographic technique for separation of proteins and nucleic acids under the influence of electric current. The separation of molecules is generally based on their size, charge and shape. Different types of medium are used for separation. Being negatively charged molecule DNA moves towards positively charged electrode when influenced by electric current.

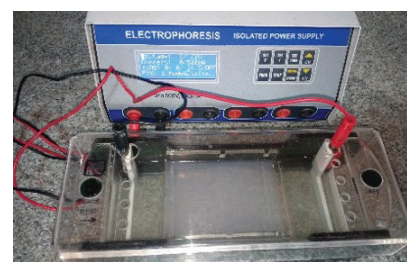

APPENDIX B: PUC Experiments

In the following, we have given short write-up on each experiment for the reader to know what the experiments are done by PU teachers. A few experiments are repeat of high school experiments because the PU teachers have not done many of those. Also, in PU they need to teach the subject in more detail. Therefore, doing these experiments is helpful. These experiments can be done by the students also. Only about 10 of these experiments are prescribed in PU physics laboratory. Further, PU teachers when they do the same experiments of high school physics, they derive more information. The following experiments are performed by every teacher during the PUC teachers' training. In each section, the subjects covered in the theory is verified in the laboratory. * indicates that experiment is designed/modified in TDC.

PUC PHYSICS EXPERIMENTS

Electricity and Magnetism Experiments

1. Cathode Ray Oscilloscope and Digital Multimeter

Cathode ray oscilloscope (CRO) is an electronic measurement device which provides a two-dimensional visual representation. It utilises the properties of cathode rays of being deflected by an electric and magnetic field and of producing scintillations on a fluorescent screen.



A digital multimeter is an electronic instrument that combines several measurement functions in one unit. A typical multimeter can measure voltage, current and resistance.

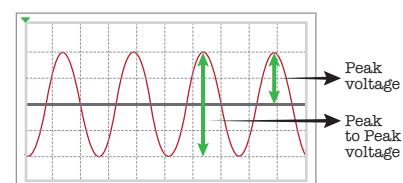

2. Resistivity of metals – Meter Bridge*

Specific resistance or resistivity of a material is an intrinsic electrical property of a metal. It is denoted by ρ in Ωm . This is the only method to measure resistivity of metals. Instrument shown here is a simplified instrument developed at TDC, takes less time to measure ρ for many metals. Here teachers measure resistivity of Cu, Fe and Kanthal wires to find the variation of resistivity of different metals and alloys.

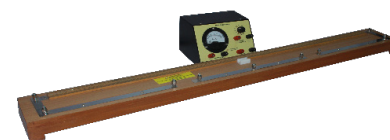

3. Temperature coefficient of resistance ' α ' of metal*

Resistance of a metal like Cu increases with increase in temperature. Dip the copper coil in the hot water bath and measure the resistance of the coil as the water cools as a function of temperature till room temperature. Plot a graph of resistance(Y) vs temperature (X). Calculate the temperature coefficient of resistance of copper. This is a simple experiment designed at TDC but it is a profound experiment giving accurate result. Experimental set is simple, low cost.



4. Drawing the Electric Field Lines of Force*

General concept of lines of force (gravitational, electrical or magnetic) is that the lines of force start higher potential energy position and move to lower potential energy position. The lines of force are perpendicular to the equipotential energy lines. This is a novel experiment designed in TDC.

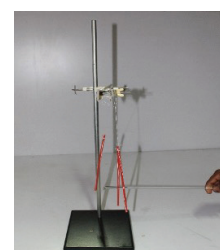

5. Parallel plate capacitor and combination of capacitors*

i) Experiment is to construct parallel plate capacitors and find the separation distance (thickness) of the parallel plate capacitor.

ii) Verification of law of effective capacitance when connected in series and parallel. Measure capacitor using LCR meter and calculate the thickness of paper dielectric. Measure the thickness of paper dielectric using slide caliper and compared with calculated value.

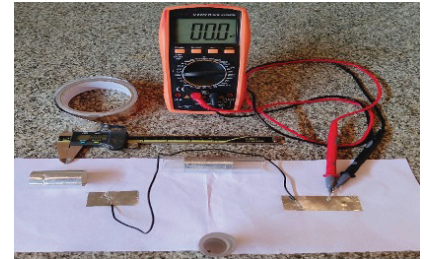

6. Charging and discharging of capacitor*

A capacitor when charged with a voltage source, it charges exponentially. A similar exponential decay is observed when the fully charged capacitor is discharged.

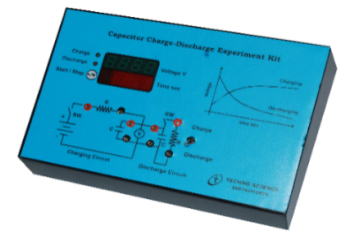

7. Current and Voltage phase difference in RC circuit*

In an AC circuit containing resistor (R) and capacitor (C), the voltage across the resistor is in same phase with current and the voltage across the capacitor lags behind the current by 90° . Use CRO to find this. From the figure we can find phase difference by using

$$\phi = \sin^{-1} \frac{Y_0}{Y_{max}}$$

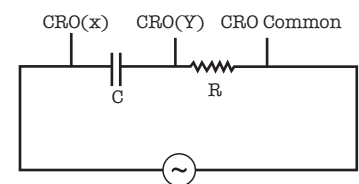
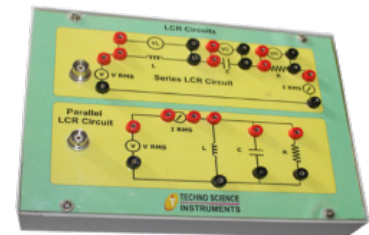

8. Current-Voltage phase difference in RL circuit*

In an AC circuit containing resistor (R) and inductor (L), the voltage across the resistor is in same phase with current and the voltage across the inductor leads the current by 90° . Because of this, the resultant voltage also leads the current by phase difference of ϕ .

$$\phi = \sin^{-1} \frac{Y_0}{Y_{max}}$$

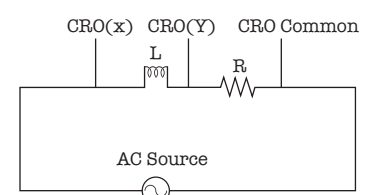
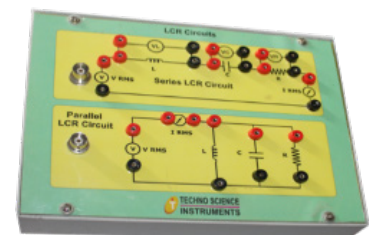

9. Series resonance of an RLC circuit*

In a series RLC circuit, resonance occurs when inductive reactance equals the capacitive reactance. At resonance,

$$X_L = X_C \Rightarrow \omega L = 1/\omega C \Rightarrow 2\pi fL = 1/2\pi fC$$

$$f = \frac{1}{2\pi\sqrt{LC}}$$

Also, series impedance of an RLC circuit is $Z = \sqrt{R^2 + (X_L - X_C)^2}$.

Excellent kit is designed at TDC.

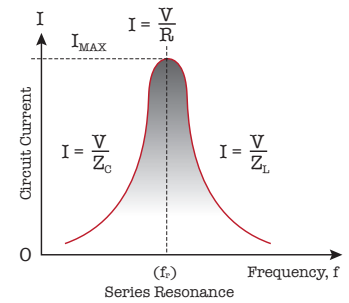
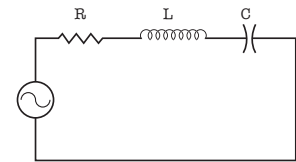

10. Parallel resonance of an RLC circuit*

At resonance, $X_L = X_C$

$$\omega L = 1/\omega C \Rightarrow 2\pi fL = 1/2\pi fC;$$

$$f = \frac{1}{2\pi\sqrt{LC}}$$

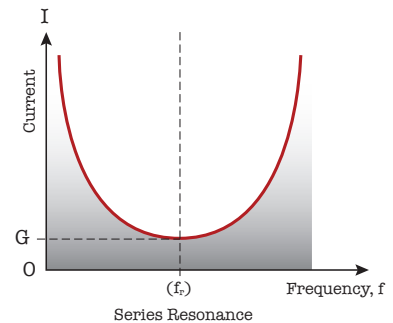
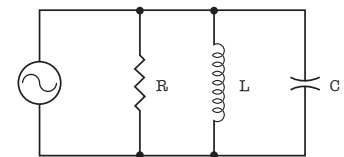

11. Mapping of magnetic lines of Force*

Mapping of Magnetic lines of force of a bar magnet to find its magnetic moment. A null or neutral point is that point at which the Earth's magnetic field is nullified by the field due to bar magnet. Teachers draw the fields and find null point d and magnetic moment is obtained from the value of d .

$$M = \frac{4\pi d^3 B_H}{\mu_0} \text{Am}^2$$

12. Strength of magnetic field due to a solenoid and cylindrical magnet*

A solenoid is a helical coil which can produce magnetic field when an electric current is passed through it. The magnetic field produced depends on the number of turns per unit length, current in the solenoid and geometry of the coil. In the present TDC designed experiment, magnetic field produced by an air core solenoid along its axis is studied.

13. Hall probe IC*

The probe is a semiconductor device in which a small voltage is generated, proportional to the component of magnetic field applied perpendicular to its plane. The voltage is amplified and read on a voltmeter. In the presence of a magnetic field B, the multimeter reading changes to V. The strength of the field is obtained using the relation $B = 0.14 \times \Delta V$ in Tesla. This is a TDC expt.

14. Determination of Earth's magnetic field - Tangent galvanometer*

This is a standard experiment to determine the Horizontal component of the Earth's magnetic field B_H at a place using tangent galvanometer.

In TDC, the experiment is simplified by employing a constant current source to the magnetic coil and time taken to experiment is reduced to just 30 min.



15. Comparison of Magnetic Moment of two bar magnets - Deflection Magnetometer

To compare the Magnetic moments of two bar magnets (M_1/M_2) using the ratio of the magnetic moments of the two magnets A and B is calculated using the formula

$$M_1 / M_2 = d_1^3 / d_2^3 \text{ or } = \text{Tan}(\theta_1) / \text{Tan}(\theta_2)$$

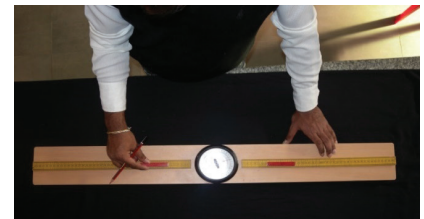

16. Quincke's Method to find Magnetic susceptibility

Quincke's Method is used to determine the magnetic susceptibility.

A sample in the form of a liquid, placed in between the pole pieces. The level of the liquid placed in between the magnetic field will rise which can be detected using digital travelling microscope.

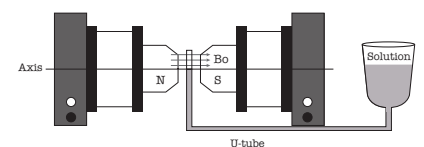

17. Measurement of self-inductance of an inductor*

In a series RL circuit, we know that the effective impedance is given by, $Z = \sqrt{R^2 + X_L^2}$

Where R is the internal resistance of the coil.

Also, we know that

$$Z = \frac{V_{rms}}{I_{rms}}$$

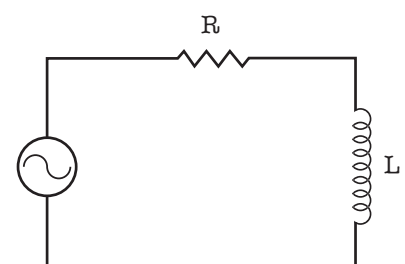

18. Diode Characteristics*

Diode is a semiconductor device, which allows easy flow of current only in one direction (unidirectional device). It consists of a junction formed by a p-type and n-type semiconductor. The relation between the current flow and applied voltage is a non-linear curve. There is a large flow of current in forward bias mode after exceeding the knee voltage, while negligible current (nA) flows in reverse bias mode.



19. Zener diode characteristics*

Zener diode is a heavily doped p-n junction diode which is made to conduct heavily in breakdown region. It works as a normal diode in forward bias mode, while in reverse bias, it acts as a voltage regulator. In this experiment, we study both forward and reverse bias characteristics. We also find the breakdown voltage and understand how it acts as a voltage regulator.



20. Rectifier circuits

Most of the electronic circuits work on low DC voltage. The voltage supplied to household is 220V ac. Thus, we need to convert high voltage AC to low voltage DC. The high AC voltage is first stepped down to low voltage AC using a transformer. Then it is converted to DC using a rectifier circuit. A single diode converts only one-half wave of AC input, a two-diode circuit fully converts both half waves into DC. A bridge rectifier circuit needs four diodes connected in a bridge fashion. A capacitor smoothen the pulsating DC voltage, which appears across the load resistor.

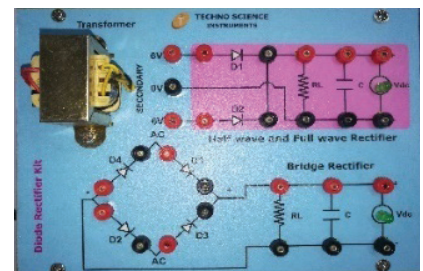

21. Transistor characteristics*

Transistor is a two junction three terminal device. Transistor comes in two configurations; NPN and PNP. The emitter-base junction should be forward biased while collector-base junction should be in reverse bias. Two important applications of a transistor are (a) Amplifier (b) Switch. In this experiment, we study the input and output characteristics of an NPN transistor. We will find the current gain α and β in a CE mode.

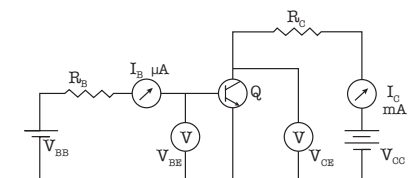

$$\beta = \frac{\Delta I_c}{\Delta I_B} = \frac{I_{c2} - I_{c1}}{I_{B2} - I_{B1}}; \quad \alpha = \frac{\beta}{1 + \beta};$$

22. Transistor (Common Emitter) Amplifier Circuit*

Transistor common emitter amplifier circuit consists of a voltage divider bias, an input coupling and an output coupling capacitor for coupling the AC signal to input and output respectively. To create an AC ground at the emitter, a bypass capacitor across the emitter resistor is used.

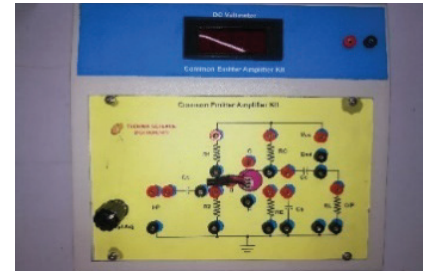

23. Logic Gates verification*

A simple two input logic gates can be constructed using diodes, transistor and resistors, switches and LEDs. Similarly, using the universal gate concept, all types of logic gates can be built. For this, uncommitted two input NAND gates from the IC 74LS00 are used. Finally, the truth table is drawn for four input combination for all the gates and verified.

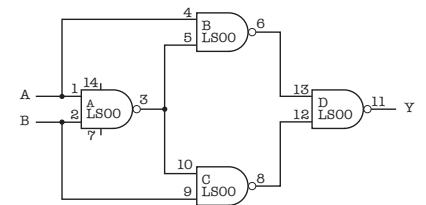
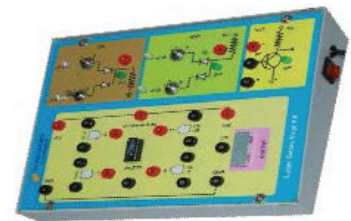

24. Amplitude modulation – demodulation*

This expt. kit is newly developed to measure the frequency and amplitude of modulated and demodulated wave forms.

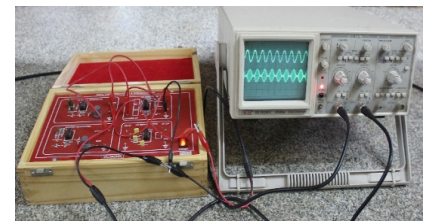

25. Voltage Regulator Power Supply*

A regulated power supply is a device which convert unregulated AC source to a regulated DC source.

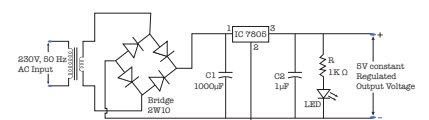

26. Working of Voltage Regulator IC 7805*

IC 7805 is a 5V Voltage regulator IC that restricts the voltage output to 5V. 7805 comes with provision to add heat sink. The maximum value for input to the voltage regulator is 35V. This is a good experiment which can be a useful skill for the teacher.

27. Working of Voltage Regulator IC LM317*

The LM317 regulator can provide excess output current and hence with this capacity, it is conceptually considered as an operational amplifier. The adjustment pin is the inverting input of the amplifier and to produce a stable reference voltage of 1.25 V, an internal bandgap reference voltage is used to set the non-inverting input.

Experiments on Mechanics

28. Determination of linear dimensions and density of solids and liquids*

This experiment is to measure density of solids and liquids by dimension and buoyancy. This is a newly designed experiment at TDC. This is a fundamental experiment for all the scientists. Almost no teacher knows how to measure buoyancy.



29. Determination of g, acceleration due to gravity

$g = 4 \pi^2(L/T^2) \text{ ms}^{-2}$; Measure L and T and get g ms^{-2} . Vary L and mass and prove that g does not depend upon mass and length of pendulum. Measure time by digital timer with 0.01 sec accuracy. This Method to measure time correctly is introduced here in TDC. Digital timer is now introduced. Plot L vs T and L vs T^2 graph. By this fudging results is avoided. Generally, if you ask the students do the experiment, they try to get $g = 9.81 \text{ ms}^{-2}$ by fudging the data. In fact a lots of teachers did this in TDC. If you ask to plot L vs T or L vs T^2 they need to take more data and so they cannot fudge the results.

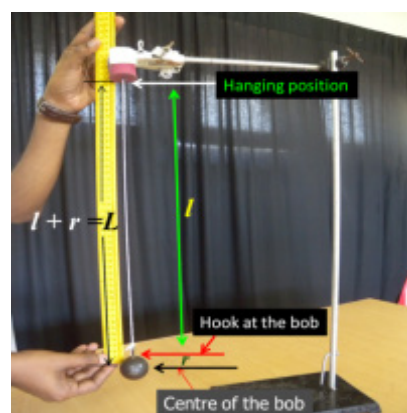

30. Transformation of energy from one to another*

Conservation energy said that total energy of a system can neither be created or destroyed but it can be transformed from one form to another form. The total energy (potential energy + kinetic energy) is always constant for an object.

$\frac{K.E}{P.E}$ and $P.E. - K.E.$ give frictional loss by a simple method developed in TDC. This kit is made by TDC.

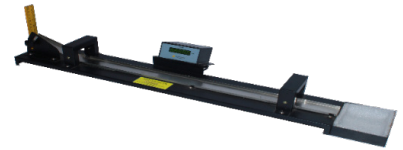

31. Centre of mass*

Centre of mass of an object (or system of mass particles) is a unique, hypothetical point where entire mass of the object may be assumed to be concentrated. It is the point particle equivalent of a given object for application of Newton's laws of motion. At this C.M. point the weighted relative position of the distributed mass sums to be zero. This is a newly designed experiment at TDC.



32. Inclined plane – velocity and acceleration of a rolling body*

Mechanics is about the relationship between acceleration and velocity. This experiment is designed to verify the effect of acceleration on velocity. Consider a spherical ball starts rolling without slipping on an incline plane with inclination of α . Thus, the acceleration acted on the ball is $g \cos \alpha$. By varying the angle of inclination, velocity of the ball will also vary. This is experiment designed at TDC.



33. Atwood's Machine*

The purpose of this experiment is verification of Newton's second laws of motion. An ideal Atwood Machine consists of two objects connected by an inextensible massless string over an ideal massless pulley. When both the masses are equal, the machine is in neutral equilibrium regardless of the position of the weights. If both the masses are not equal both masses experience uniform acceleration. This simple device was invented by English mathematician George Atwood in 1784 as a way to demonstrate and verify Newton's Laws of motion with constant acceleration. Newton's Second Law of Motion says that the force required to move something equals the object's mass times its acceleration.

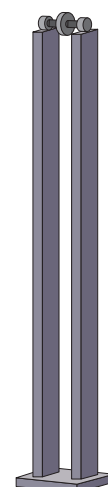

34. Projectile Motion*

The projectile motion known to the mankind from the times of Archimedes is an example for two-dimensional motion.

There are three kinds of projectile motion. Horizontal projectile motion; ground to ground projectile and projectile launched from a height at an angle. Range is determined in each case. This is an experiment designed in TDC.

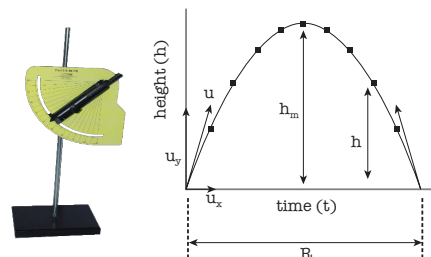
**35. Spring Constant***

When a force is applied to a solid, it causes deformation on the solid. For small deformation, stress is proportional to strain. This is Hooke's law. The constant of proportionality is called the spring constant. Within the elastic limit of a spring of length (L), a force (F) is applied in the direction of spring length causes an extension x , then $F = -k \cdot x$; where k is spring constant. The value of k is also measured for the same spring by the PU teacher from oscillation frequency of the spring, designed in TDC.

**36. Compound pendulum***

To determine acceleration due to gravity and radius of gyration of a compound pendulum bar about its centre of mass. This is a standard experiment prescribed for PUC.

Determination of radius of gyration: From the graph, we note that $PM = SM = l_1$ and $RM = QM = l_2$ and hence the radius of gyration about the axis passing through C is given $k = \sqrt{l_1 l_2}$ the mean value of k is calculated.

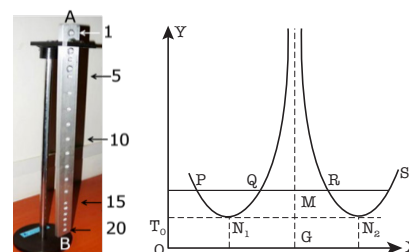
**37. Equilibrium of concurrent coplanar forces**

Equilibrium of concurrent coplanar forces is to verify,

- law of parallelogram of forces
- Converse of law of triangle of forces
- Lami's theorem

**38. Moment bar: Equilibrium of parallel forces***

Moment bar: Equilibrium of parallel forces to verify the conditions of equilibrium of parallel forces.

Principle: Sum of clockwise moments = sum of anticlockwise moments, moments taken about any point in their plane.



39. Moment of Inertia – Parallel axis theorem*

The purpose of this experiment is to verify the parallel axis theorem of moment of inertia.



40. Moment of inertia*

(denoted by symbol I) is a physical quantity that gives us how the mass of a rotating object is distributed about its axis of rotation. Mathematically it is defined as the total sum of product of constituent masses with their perpendicular distances from the axis of rotation. That is $I = \sum_i m_i r_i^2$, where r_i is the perpendicular distance of the m_i th particle from the axis of rotation. Moment of inertia determines the amount of torque needed to be applied to change its angular acceleration.

It is cumbersome to calculate the moment of inertia of an object about an arbitrary axis. However Parallel-Axis Theorem often simplifies the calculation.

41. Moment of Inertia of a flywheel*

The purpose of this experiment setup is to determine the moment of inertia of a flywheel.

$$K.E. = \frac{1}{2} I \omega^2$$

The above equation shows that rotating body having large moment of inertia (like flywheel) can be used to store large amount of energy. This instrument is designed and developed here in TDC. This is a good experiment to learn rotation mechanics, made in TDC.



42. Conservation of linear momentum*

This experiment is to verify the law of conservation of linear momentum with the help of the two-dimensional collisions



43. Determination of Viscosity of Liquid*

In the past, Stoke's method was used where η of only highly viscous liquids like oils were measured. The method was not useful to measure η of water for example. We spent considerable amount of time to find suitable method to find η of any liquid and we find that Poiseuille flow method is cheaper, need only a burette, timer and a capillary. In 30 min, one can find η . This is a simple experiment developed in TDC.

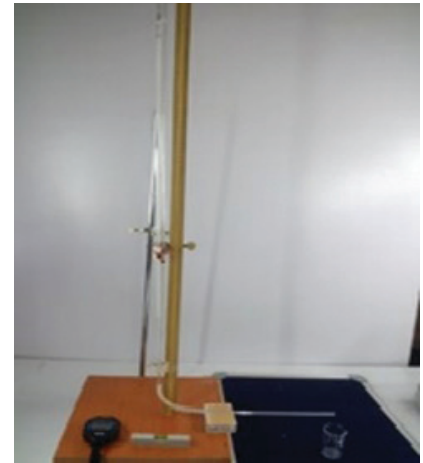

44. Surface Tension of Water by Capillary Rise

Determine the surface tension of water by capillary rise method. Surface tension is a phenomenon on the surface film of a liquid caused by the cohesive forces among the liquid molecules which tends to minimise surface area. Shape of liquid droplets is responsible by surface tension. Surface tension, T of water can be determined by using the formula,

$$T = \frac{hgr\rho}{2} \text{ Nm}^{-1}$$

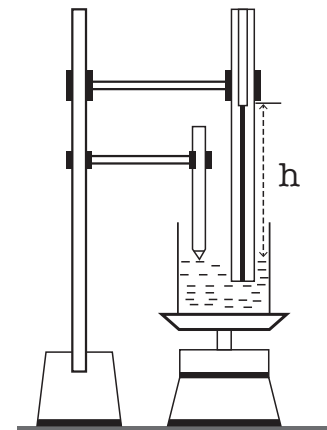

45. Young's Modulus – Searle's Method

Within the elastic limit, the ratio of tensile stress (σ) is to the longitudinal strain (ϵ) is defined as Young's modulus (Y) of the material. The strain produced on a material is independent of whether the stress is tensile or compressive. Young's modulus of the material of the wire is

$$Y = Mgl / \pi r^2 x \text{ (Pascal)}.$$

This is a standard experiment for PU.



46. Moment of Inertia and Rigidity Modulus*

The purpose of this experiment setup is to determine the rigidity modulus of the material of the given wire. Rigidity modulus using equation is $\kappa = \pi \eta r^4 / 2l$

The purpose of this experiment setup is to determine the moment of Inertia of a disk and dumb bell. The moment of inertia of the dumbbell about the axis passing through its centre of mass is given by

$$I = 2\left(\frac{1}{4}ma^2 + \frac{1}{12}ml^2 + \frac{1}{4}m(r_1^2 + r_2^2)\right) + \frac{1}{12}ML^2$$

This is an experiment developed in TDC.



47. Determination of velocity of sound - Resonance Column*

When a vibrating system (external force) drives another system, the latter system oscillates with maximum amplifying amplitude if driven frequency exactly matches with natural frequencies of the latter. This phenomenon is known as resonance. Using resonance phenomenon, velocity of sound can be determined. Idea of air column is new. Formula:

Velocity of sound at a temperature (T°C) in air medium is $V = 2f(l_2 - l_1)$; The velocity of sound at 0°C in air is

$$V_0 = \frac{V}{\sqrt{1 + \frac{T}{273}}}$$

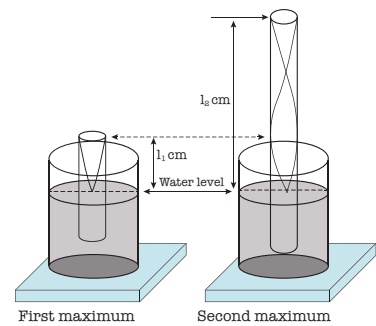

48. Sonometer – Verification of Laws of Transverse Vibrations of Stretched String

The purpose of this experiment is that, first and second laws of transverse vibrations of a stretched string using sonometer, i.e., to show

- (i) $nl = \text{constant}$ and
- (ii) $\frac{\sqrt{T}}{l} = \text{constant}$.



49. Solar constant*

The solar constant (S) is the amount of energy incident normally per unit area per unit time on the surface of earth. This can be determined by exposing a metal plate normal to solar radiation and measuring its raise in temperature. Once S is obtained the Luminosity of Sun can be estimated.



Heat, Gas laws and Thermodynamics

50. Measurement of atmosphere pressure by Hg barometer*

Atmospheric pressure is defined as the force per unit area exerted against a surface by the weight of the air above that surface of a planet. It varies with latitude. The average sea-level earth's atmospheric pressure is $1013.25 \text{ mbar} = 101.325 \text{ kPa} = 760 \text{ mmHg}$. At low altitudes, for every 100 m above the sea level the pressure decreases by about 1.2 kPa. Here we measure atmospheric pressure using mercury barometer.

$$P = \rho gh \text{ Pascal}$$

$$h = 0.76\text{m}; \rho = 13590.5 \text{ kg/m}^3; g = 9.81 \text{ m/s}^2;$$

$$P = 101.325 \text{ kPa}$$

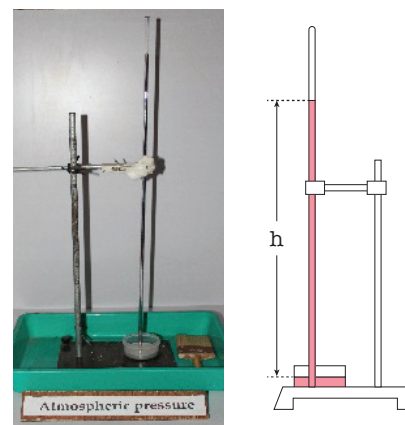

51. Verification of Boyle's law*

Principle: Boyle's law states that at constant temperature volume (V) of any dry gas is inversely proportional to pressure (P).

$$V \propto \frac{1}{P} \text{ or } P V = \text{Constant.}$$

This is a TDC designed experiment.



52. Gas Law (Gay-Lussac law) / Charles' Law*

Charles' law and Gay-Lussac law namely pressure is proportional to temperature at constant volume is verified here. A one litre glass bulb connected to a manometer is dipped in hot water, pressure and temperature are measured from Δh and plot of P vs T shows straight line. Designed in TDC.



53. Determination of Absolute Zero*

In this experiment, the relationship between pressure and temperature of given gas under constant volume is measured from room temperature to liquid nitrogen temperature. Plot of P vs temperature gives absolute zero. Designed at TDC.



54. Linear thermal expansion coefficient*

Here linear coefficient of thermal expansion of wire is measured by applying current to the wire to expand. By applying Pythagoras theorem one can find linear coefficient of thermal expansion of a metal. Accuracy is 1 mm in 1000 mm. This expt. is designed in TDC.

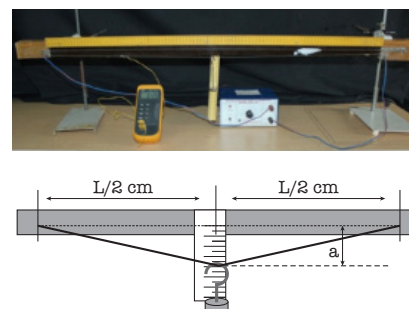

55. Volume expansion coefficient of liquid*

We determine volume expansion coefficient of water and different liquids. Here we use a burette to determine volume expansion coefficient of liquid. Designed in TDC.

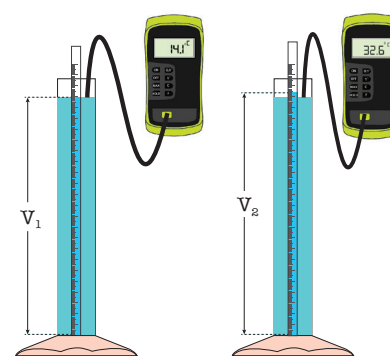

56. Specific heat of metal*

Specific Heat capacity of an object is the amount of heat energy supplied per unit mass of the object to raise its temperature by 1°C. Its SI unit is J kg⁻¹K⁻¹ and it is defined as the amount of heat energy required to raise 1 kg mass of the object by 1 K. This is TDC designed expt.



57. Heat conductance*

In this experiment, thermal conductivity of different metals is determined by directly feeling the heat conduction by fingers. Designed in TDC.



58. Specific heat of liquid*

When a current I is passing through a resistor for a period of time, the electrical energy can be converted in to heat energy following Joules heating effect. If the resistor is inside a liquid medium, then, this heat energy form electricity can in turn rise the temperature of the liquid.

Formula: Energy supplied by heater = heat gained by water + Heat gained by calorimeter

$$I^2 \times R \times t = M_w \times S \times \Delta T + (M_c \times S_c \times \Delta T)$$

$$S = \frac{I^2 \times R \times t - M_c \times S_c \times \Delta T}{M_w \times \Delta T} \quad \text{Developed in TDC.}$$

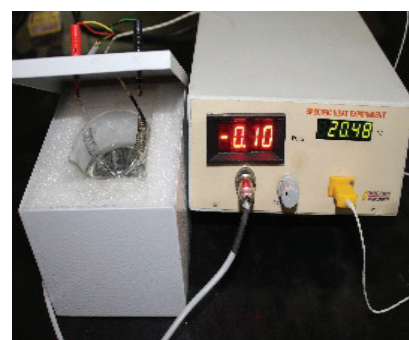

59. Latent heat of fusion of ice*

If we supply heat to a solid ice then it can convert from solid state to liquid state without changing its temperature. The heat energy released or absorbed by an object during a thermodynamic process without changing its temperature is called latent heat, like ice's change of phase from solid to liquid at 0°C, change of phase from liquid water to steam at 100°C. Latent heat of fusion or enthalpy of fusion is the latent heat of the object when the object undergoes its phase change from solid to liquid at constant temperature. EXPT from TDC.



60. Newton's law of cooling*

According to Newton's law of cooling the rate of heat loss of a hot body is proportional to the difference in temperature between the hot body and its surroundings. i.e.

$$\frac{dQ}{dt} \propto -(\theta_{body} - \theta_{sur}) \text{ or } \log_e(\theta_{body} - \theta_{sur}) = -kt + C$$

Where θ_{body} = hot body temperature;

θ_{sur} = surrounding temperature; t = time.

In this experiment, we verify Newton's law of cooling that how the temperature of liquid varies with surrounding temperature. ΔT Decreases exponentially with time, expt. designed in TDC.



61. Universal Gas Constant*

In this experiment, the universal gas constant R is determined. Clever idea to measure volume of hydrogen at atmospheric pressure generated by 10 mg of Mg is discovered to measure R from the ideal gas equation:

$$PV = nRT.$$

This is a good experiment designed in TDC.

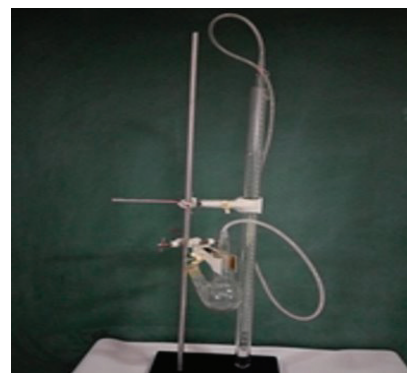

62. Determination of C_p/C_v for different gases using Resonance Column*

The velocity of sound at room temperature can be determined using resonance column by,

$V_s = 2f(l_2 - l_1)$ where l_1 and l_2 are the lengths of column for successive maximums (resonance). The velocity of sound in any gas is given by

$V_s = \sqrt{\gamma RT/M}$ where R is the universal gas constant (J/mol), T is the temperature (K) of gas and M is the molecular mass (kg/mol) of the gas. γ is the ratio of C_p/C_v . So, measure V_s in different gas. You will get C_p/C_v , an experiment designed in TDC.



Experiments in Light

63. Laws of refraction and determination of lateral shift (Snell's law)

The two laws of refraction verified by glass slab and find the lateral shift of a light ray when passing through a glass slab. The refractive index of the flint glass is determined by the Snell's law.

Formulas:

$$L_{\text{calculation}} = t \times \frac{\sin(i-r)}{\cos(r)} ; \eta = \frac{\sin(i)}{\sin(r)}$$

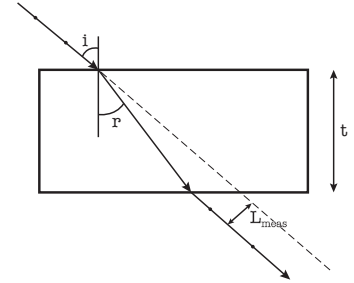

64. Focal length of convex lens

We determine the focal lengths of convex lens using distant object method and u-v method. Newly designed optical bench is introduced in this experiment. Here we find the power of lens also.

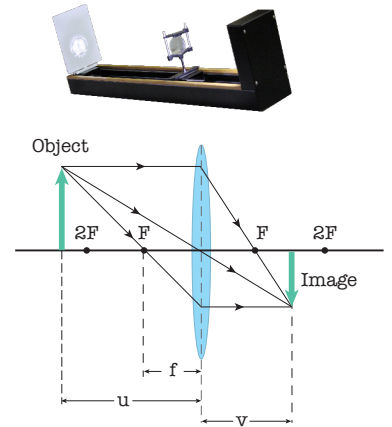

65. Determination of focal length of concave lens using convex lens – combination and separation method*

Determine the focal length of the concave lens using convex lens. A good combination of concave and convex lens is used in this experiment.

Combination of lens $\frac{1}{F_2} = \frac{1}{v} + \frac{1}{u}$;
 concave lens $F_3 = \frac{F_1 \times F_2}{F_1 - F_2}$

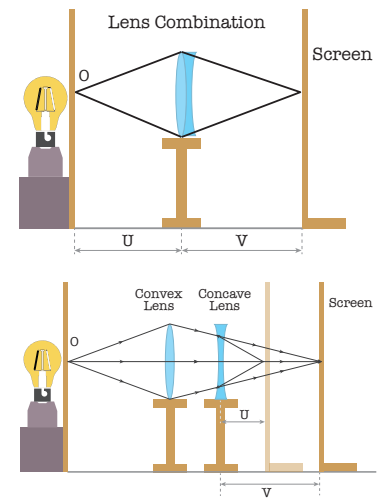

66. Focal length of concave mirror*

In this experiment, we find the focal length of concave mirror using distance object method and u-v method.

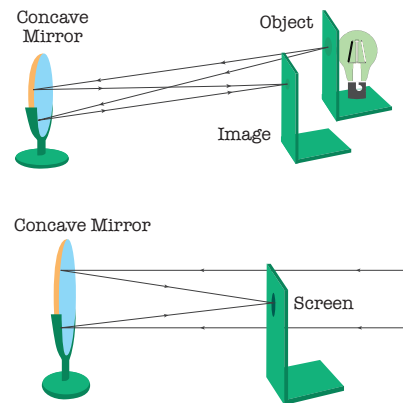

67. Refractive index of a prism

In this experiment, determine the refractive index of the prism by finding the angle of minimum deviation.

Refractive index of prism is given by

$$\eta = \frac{\sin\left(\frac{A+D_m}{2}\right)}{\sin(A/2)}$$

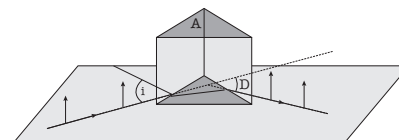

68. Refractive index of a liquid – Shift Method

To determine the refractive index of a liquid by shift method using a traveling microscope. The Position of real and apparent height is measured by using travelling microscope. Then calculate the refractive index by formula

$$n = \frac{\text{Real depth}}{\text{Apparent depth}} = \frac{R_3 - R_1}{R_3 - R_2}$$



69. Refractive Index of Colours – Glass Prism – Spectrometer

This experiment is to determine angle of the glass prism, angle of minimum deviation of different colours and refractive index of given glass prism. Angle of the prism, $A = \frac{R_1 - R_2}{2}$ (degree) where R_1 = total reading in one Vernier for the reflected image, R_2 = total reading in the same Vernier for the reflected image on the other refracting face. Refractive index of the prism,

$$\eta = \frac{\sin\left(\frac{A+D}{2}\right)}{\sin(A/2)}$$

Angle of minimum deviation, $D = R_3 - R_4$ (degree).

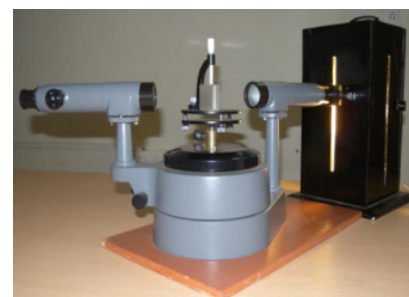

70. Refractive Index of liquid Hollow Prism – Spectrometer*

This experiment is to determine the refractive index of colours for given liquid in hollow prism. Repeat the above experiments with hollow prism with a liquid.

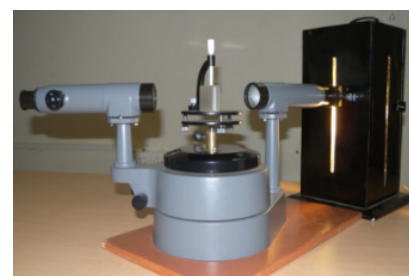

71. Determination of Specific rotation*

To determine the specific rotation of given sugar solution. **Formula:** $\theta = Slc$ where θ = angle of rotation of the plane of polarisation S = specific rotation, l = length of the liquid column(m), c = concentration of the optically active liquid (kg.m^{-3})



72. Wavelength of light – Diffraction Through grating*

In this experiment, determination of wavelength of laser light source using diffraction grating.



73. Diffraction due to Reflection Grating*

To observe the diffraction pattern of laser using a fine stainless steel 6-inch scale and hence to determine the wavelength.

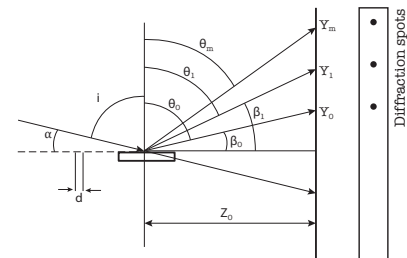

74. Determination of grating constant*

To determine the grating constant of the given grating.

Formula: $\sin(\theta) = Nm\lambda;$

N = Number of lines per unit length, m = order of the spectra, λ = wavelength of the light used.



75. Newton’s Rings

To determine the radius of curvature of a given convex lens using Newton’s rings experiment.



76. Energy of a photon*

We observe the dispersion of light to determine the wavelength of different colours of light using digital spectrometer and calculate the energy of a photon associated with them. This is an excellent experiment to determine the energy of a photon. Expt. designed in TDC. Constant deviation digital spectrometer is jointly developed and popularised by TDC and Kamaljeet. In this spectrometer emission lies from any discharge tube, flames and arc can be measured in just 3 min. The most important equation of Quantum of light $E = hv$, Planck equation is verified here. This is one of the best physics and chemistry experiments to understand energy of a photon.



77. H₂ Lamp – Hydrogen emission spectra*

In this experiment, we measure the wavelength of the Balmer line from the hydrogen lamp and find the energy of red light of hydrogen emission spectrum = 1.89 eV, Verifying Bohr's theory of light emission from H atom.



78. Hydrogen Spectra and determination of Rydberg Constant*

Principle: Rydberg constant is one of the fundamental constants given by the equation

$$E_n = -Z^2 \frac{R}{n^2}$$

where R = Rydberg constant, E_n = Energy level of Hydrogen with principal quantum number, $n = 1, 2, \dots$ and Z is atomic number (1 for H, 2 for He¹⁺)

In a hydrogen discharge tube, electron occupied in the ground state $n = 1$ of Hydrogen atom is excited to the higher energy levels. They come back to $n = 1, 2, \dots$ states giving rise to Lyman, Balmer, Paschen series. Balmer lines are in visible region of the electromagnetic spectrum.

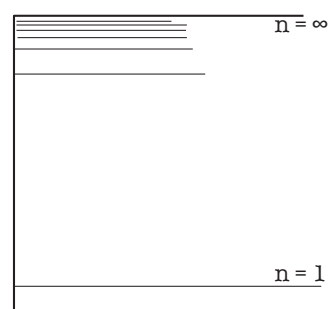

79. Determination of Planck's constant – Photoelectric effect*

We determine the Planck's constant using different filters. By plotting a graph frequency vs stopping potential, we can find Planck's constant and work function of photosensitive metal. Formula:

$$h = \frac{eV}{\nu} = e \times \text{slope};$$



80. Determination of e/m of electron*

To determine the ratio of electronic charge 'e' to the mass 'm' of electron by Thomson's method.

$$\text{Formula: } \frac{e}{m} = \frac{1}{KB_H^2} \left(\frac{V_y}{(\tan \theta)^2} \right)$$

$$K = 12.3 \text{ cm} \times 3.1 \text{ cm} \times 2.8 \text{ cm} = 106.7 \text{ cm}^3 = 106.7 \times 10^{-6} \text{ m}^3; B_H = 40 \mu\text{T} = 40 \times 10^{-6} \text{ T}.$$



81. Wavelength of light in water, refractive index of water, velocity of light in water*

Determination of distance between grating lines using the formula

$$d = \frac{\lambda}{\sin \theta};$$

Determination of wavelength of a liquid, refractive index of liquid and speed of light in liquid using the formula:

$$V_L = \frac{3 \times 10^8 \text{ ms}^{-1}}{\mu_L}; \text{ This is a TDC experiment.}$$

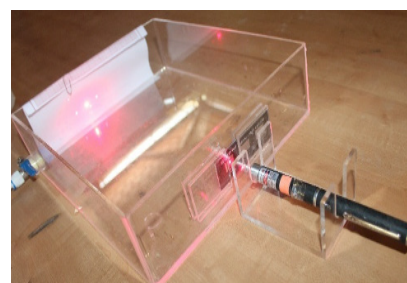

82. Millikan's Oil Drop Experiment for e/m^*

In this experiment, the charge and radius of oil drops will be determined using the Millikan's apparatus. In this celebrated experiment, an electric field applied across the plates of the capacitor will balance the weight of a charged oil drop along with the viscous and buoyant force. This is a difficult experiment

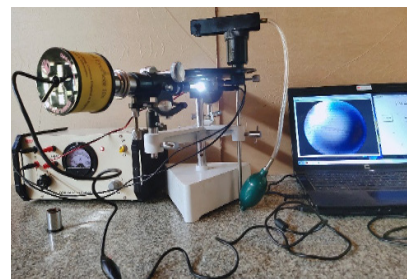

83. Determination of Avogadro number*

The experiment of electrodeposition of copper is used to determine Avogadro number. A known quantity of electricity is passed through copper sulphate solution using copper plate as anode and stainless steel as cathode. The mass of copper deposited is proportional to the quantity of electricity passed.



PUC CHEMISTRY EXPERIMENTS

Electronics for PU chemistry teachers: This is found necessary because they do not have any idea of measurement. Certain minimum experiments to learn how to accurately measure in addition to increase the skill of teachers, this is introduced. Under the topic Solids, they need to study resistance, band gap, LED and so on. Some of the experiments which are demonstrations to high school teachers are the experiments done by students in PU. Therefore, some amount of repetition of high school experiments is inevitable. However, all these experiments form part of Chemistry syllabus for PU teachers and so they do these experiments to learn chemistry.

Electronics

1. Verification of Ohm's law

The current flowing through a conductor is proportional to potential difference across it. For a given potential difference the current flow depends on the property of the conductor, which is measured in terms of either resistance or conductance. This is known as Ohm's law.

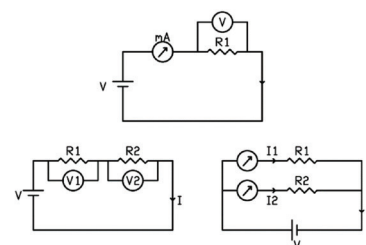

2. Determination of resistivity of metals

Specific resistance or resistivity of a material is an intrinsic electrical property of a material that quantifies how strongly a given material opposes the flow of electric current. It is independent of shape and size of the material. It is denoted by ρ (rho) and its unit is Ωm (= Ohm meter).

$$\text{Resistivity: } \rho = \frac{\pi d^2 R}{4L} \Omega\text{m}$$



3. Diode and LED Characteristics

Diode is a semiconductor device, which allows easy flow of current only in one direction (unidirectional device). It consists of a junction formed by a p-type and n-type semiconductor. The relation between the current flow and applied voltage is a non-linear curve. There is a large flow of current in forward bias mode after exceeding the knee voltage, while negligible current (nA) flows in reverse bias mode.

4. Zener diode characteristics

Zener diode is a heavily doped p-n junction diode which is made to conduct heavily in breakdown region. It works as a normal diode in forward bias mode, while in reverse bias, it acts as a voltage regulator. In this experiment, we study both forward and reverse bias characteristics. We also find the breakdown voltage and understand how it acts as a voltage regulator.

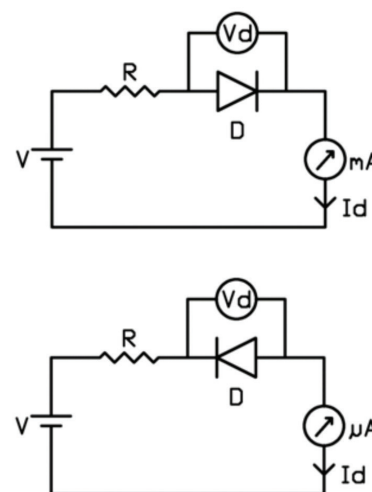

5. Measurement of temperature

Mercury is poisonous. Time taken to read is 20 to 30 seconds. High and low temperatures cannot be measured. So, mercury thermometer is now replaced by thermocouple and Pt100 thermometers.



6. Calibration of Chromel – Alumel Thermocouple

On heating the thermocouple, the voltage developed at the junction increases. Using this principle, it is possible to calibrate the thermocouple.

7. Determination of temperature coefficient of Pt100

Connect the given Pt100 to the multimeter. Set the multimeter to resistance range. Dip the Pt100 into the beaker containing ice and note down the temperature. It will be close to 0°C. Note down the resistance value using multimeter. Heat the beaker. Note down the resistance for every 5°C interval up to 70–80°C. For all these 7 experiments, same equipment for physics are employed.

General Chemistry

8. Energy of a photon and electromagnetic spectrum

Energy (E) associated with a photon of wavelength (λ) and frequency (ν) is $E = h\nu = hc / \lambda$. This is a hit experiment on Planck's law. Here they use Hg lamp.

9. Determination of Planck's constant– Photoelectric effect

A colour filter (a colour glass disc) say, orange colour, is inserted in the colour filter window provided between photocell and light source when voltage is zero. Increase voltage until the photocurrent becomes zero the corresponding voltage called stopping voltage is measured. Repeat the step for different colour filters.

10. Hydrogen emission spectra Energy levels of Hydrogen and determination of Rydberg Constant

In a hydrogen discharge tube, electron occupied in the ground state $n = 1$ of Hydrogen atom is excited to the higher energy levels. They come back to $n = 1, 2, \dots$ states giving rise to Lyman, Balmer, Paschen series. Balmer lines are in visible region of the electromagnetic spectrum.



11. Determination of wavelength of Sodium lines from Na vapour lamp

Energy levels of Helium, in sodium, the splitting of D lines demonstrate failure of Bohr's theory. Then of course teach the emission spectroscopy leading to discovery of elements. The same spectrometer can be later used to show prominent lines of metals from their flames.

12. Black Body Radiation

It was found experimentally that the intensity of radiation increases with wavelength and reaches maximum at a particular wavelength and then decreases exponentially. Max Planck was able to reproduce the experimental observation using Planck's radiation law. In this experiment plotting is done by computer employing origin program.

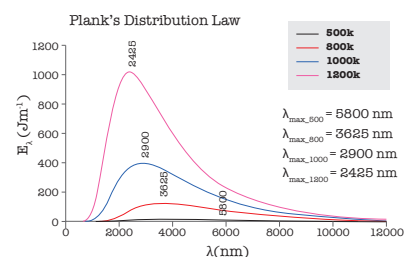

Chemical Reactions

Under qualitative analysis chemistry students used to do a lot of reactions. Now this part is no longer part BSc syllabus. Many teachers are unaware of how do chemical reactions. TDC has designed over 60 experiments on chemical reactions. Teachers are doing all the reactions in about 3 to 4 hours individually. This is highly appreciated by the teachers.

Preparation of Gases and their chemical reactions

13. Preparation of carbon dioxide

Set up apparatus as shown in the figure. Take about 10 g of marble chips in the round bottom flask. Add 10 mL of dil. HCl to the flask. Collect the carbon dioxide produced in a test tube by upward displacement of air



14. Preparation of sulphur dioxide

Sulphur dioxide can be prepared by the action of dil. HCl or dil. H_2SO_4 on sodium sulphite or sodium bisulphite.

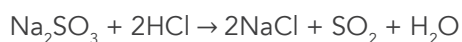

15. Preparation of chlorine

To about 200 mg of KMnO_4 taken in a dry round bottom flask, add 5 mL of conc. HCl.



16. Reaction of sodium sulfide with sulfuric acid – Preparation of H_2S gas

Add dil. sulfuric acid to the sodium sulfide solution. Observe the evolution of H_2S gas by odour.

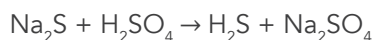

17. Reaction of metals with mineral acids

a). To study the reactions of dil. hydrochloric acid with different metals

Place about 0.2 g zinc granules in a 15 mL test tube. Add about 5 mL of dilute hydrochloric acid. Immediately zinc reacts with the acid with the evolution of hydrogen gas.

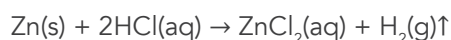

Bring a lighted match stick near the mouth of the test tube. Immediately the hydrogen gas burns with a 'pop' sound. $2\text{H}_2 + \text{O}_2 \rightarrow 2\text{H}_2\text{O}$

b). To study the reactions of dil. sulphuric acid with different metals. Zinc, magnesium, iron and aluminium react with dilute sulphuric acid giving hydrogen.

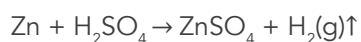

c). Preparation of oxides of nitrogen. Copper turnings react with 1:1 HNO_3 produces colourless NO gas and conc. HNO_3 on heating to liberate brown NO_2 gas.

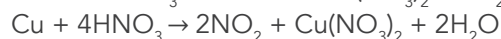

18. Reactions of metals with sodium hydroxide

Metals react with alkali also to give hydrogen. Sodium hydroxide reacts with aluminium metal liberating hydrogen.

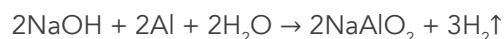

19. Reducing agents and reduction of oxides

Using charcoal, copper oxide can be reduced to copper metal. After reduction it becomes red because of formation of copper metal. Formation of Cu metal can be confirmed by the reaction with conc. HNO_3 .

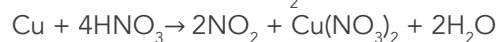
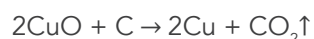

20. Enthalpies of displacement reactions

Take 2 test tubes. Take 5 mL of CuSO_4 solution in each. Add 1 g of iron powder and Mg powder. Shake both the test tubes well. Measure the lab temperature using a digital thermometer. Using the same thermometer, measure the temperature of the mixture in first test tube, and then, of the second test tube. Compare the increases in temperature

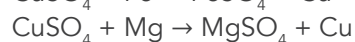
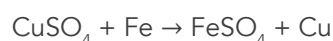

21. Reactions with Hydrogen Peroxide

Reaction with potassium iodide,
 $2\text{KI} + \text{H}_2\text{O}_2 + \text{H}_2\text{SO}_4 \rightarrow \text{I}_2 + \text{K}_2\text{SO}_4 + 2\text{H}_2\text{O}$

Reaction with silver oxide,
 $\text{Ag}_2\text{O} + \text{H}_2\text{O}_2 \rightarrow \text{H}_2\text{O} + \text{O}_2 + \text{Ag}$

Reaction with Chlorine gas,
 $\text{Cl}_2 + \text{H}_2\text{O}_2 \rightarrow 2\text{HCl} + \text{O}_2$

Reaction with KMnO_4 and $\text{K}_2\text{Cr}_2\text{O}_7$,

$$2\text{KMnO}_4 + 5\text{H}_2\text{O}_2 + 3\text{H}_2\text{SO}_4 \rightarrow 2\text{MnSO}_4 + 5\text{O}_2 + \text{K}_2\text{SO}_4 + 8\text{H}_2\text{O}$$

$$\text{K}_2\text{Cr}_2\text{O}_7 + 3\text{H}_2\text{O}_2 + 4\text{H}_2\text{SO}_4 \rightarrow \text{Cr}_2(\text{SO}_4)_3 + 3\text{O}_2 + \text{K}_2\text{SO}_4 + 7\text{H}_2\text{O}$$
22. Preparation of Inorganic Complexes

Preparation of Prussian blue complex,
 $\text{FeCl}_3 + \text{K}_4[\text{Fe}(\text{CN})_6] \rightarrow \text{KFe}[\text{Fe}(\text{CN})_6] + 3\text{KCl}$

Reaction of Cu^{2+} With NH_3 ,
 Add 1ml 5% CuSO_4 solution. Mix well. Add ammonia solution drop by drop. Observe the formation of a precipitate.

Ferric thiocyanate test,
 Add one drop of Fe^{3+} solution. Add ammonium thiocyanate drop by drop. Observe the colour formed.

Reaction of CoCl_2 with conc. HCl ,
 Take about 1 mL of CoCl_2 solution in a test tube. Add about 1mL of conc. HCl to the CoCl_2 solution. Observe the change in colour.

23. Redox Reactions

Reaction of KMnO_4 and $\text{K}_2\text{Cr}_2\text{O}_7$ with $\text{Na}_2\text{S}_2\text{O}_3$,

$$5\text{Na}_2\text{S}_2\text{O}_3 + 8\text{KMnO}_4 + 7\text{H}_2\text{SO}_4 \rightarrow 5\text{Na}_2\text{SO}_4 + 8\text{MnSO}_4 + 4\text{K}_2\text{SO}_4 + 7\text{H}_2\text{O}$$

$$3\text{Na}_2\text{S}_2\text{O}_3 + 4\text{K}_2\text{Cr}_2\text{O}_7 + 13\text{H}_2\text{SO}_4 \rightarrow 3\text{Na}_2\text{SO}_4 + 4\text{Cr}_2(\text{SO}_4)_3 + 4\text{K}_2\text{SO}_4 + 13\text{H}_2\text{O}$$

Reaction of sodium thiosulphate with conc. HCl
 $2\text{HCl} + \text{Na}_2\text{S}_2\text{O}_3 \rightarrow \text{SO}_2 + \text{S} + 2\text{NaCl} + \text{H}_2\text{O}$

Reaction between $\text{K}_2\text{Cr}_2\text{O}_7$ and KOH ,
 Take 1 mL of potassium dichromate solution in a test tube.

Add a few drops of 5% KOH . Observe the change in colour.

24. Decomposition Reactions

Preparation of oxygen by decomposition of KMnO_4

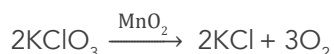

Decomposition of potassium chlorate in the presence of catalyst MnO_2 ,

**25. Chemical Reactions continued**

Reaction of Br_2 with KI solution,

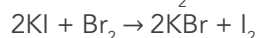

Distinguishing Fe^{2+} and Fe^{3+}

NaOH solution was added to ferrous and ferric solution, gives different coloured precipitates

Testing of iodine content in common salt,

Take about one spatula of "iodised" common salt in a watch glass. Add 4 -5 drops of lemon juice. Then add 2 -3 drop of freshly prepared starch. If iodine is present, you can observe blue coloration due to starch iodine complex.

Reaction of sodium sulfide with cobalt (III) nitrate,

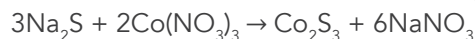

Reaction of sodium with water,

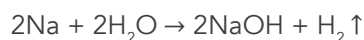

Solid-state endothermic reaction

(reaction between $\text{Ba}(\text{OH})_2$ and NH_4Cl),

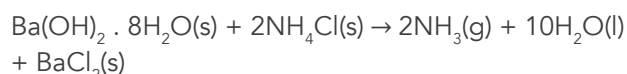
**Gas Laws and thermodynamics**

Students study this subject both in physics and chemistry and the experiments are common for physics and chemistry. For high school teachers it is a learning experience. For PU teachers, these experiments help to learn theory. While implementing it to PU teachers, rigour of doing experiments to get accurate results is insisted. They need to teach this part in Class 11. These experiments re done by physics teachers because in physics syllabus also the subject is included.

26. Measurement of atmosphere pressure by Hg barometer

Fill mercury in the glass tube fully. Close the tube by your index finger firmly and invert, open the index finger carefully inside the mercury kept in plastic bowl. Height of the Hg column falls and stops due to the atmosphere pressure.

27. Verification of Boyle's law

A manometer is constructed where one side is connected to an inverted burette and other side is a glass tube as shown in the figure. By measuring the height difference, pressure inside was calculated.

For example, When $\Delta h = 100$ cm
 Pressure inside the burette
 $= 1 \text{ atm} + (100/965.6) = 1.104 \text{ atm}$

You will find that $P \times V = \text{constant}$ within the experimental error proving Boyle's law.

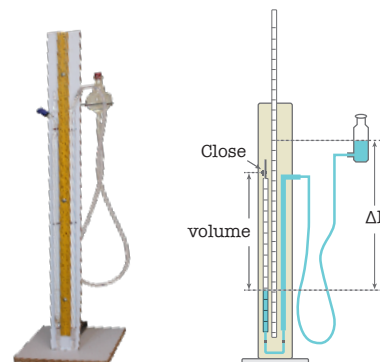

28. Verification of Charles' law*

William Charles first proposed that at constant pressure, volume of a gas is directly proportional to temperature at constant pressure. This is a difficult experiment to perform. Therefore, the second statement of Charles' law was proposed by Gay-Lussac: At constant volume, $P \propto T$. Pressure increases with increasing temperature.



29. Determination of Absolute Zero - Ideal gas law*

Dip the gas chamber into the liquid nitrogen and allow to cool up- to the liquid nitrogen temperature. Take out the gas law instrument. Record the pressure with respect to temperature. Plot the graph pressure on Y- axis and temperature on x-axis. Extrapolate the graph up to pressure is zero. That temperature is absolute zero.



30. Determination of universal gas constant R*

One mole of Zn, on complete reaction with HCl, gives 1 mole of H_2 . Volume of the gas collected is measured by using inverted burette. By maintaining the inner and outer water level same, pressure inside can be taken as atmospheric pressure. Calculate R using the equation, $PV = nRT$.



31. Determination of Cp/Cv for different gases using Resonance Column

The velocity of sound V_s at room temperature can be determined using resonance column by $V_s = 2f(l_2 - l_1)$, where l_1 and l_2 are the lengths of column for successive maximums (resonance). The velocity of sound in any gas is given by, $V_s = f\lambda RT/M$

By measuring the V_s in different gases in the resonance column, C_p/C_v of the gas can be determined.



32. Linear thermal expansion coefficient*

Connect both ends of the manganin wire fixed as in the meter bridge apparatus to power supply. At the centre of the wire (at 50 cm) hook a small weight hanger. Fix a ruler vertically near to the weight hanger in the wooden board. Connect digital thermometer to the wire.



$$\alpha = \frac{\Delta l}{LX(T_2 - T_1)} \text{ } ^\circ\text{C}^{-1}$$

33. Volume expansion coefficient of water

Substance expands or contract when their temperature changes, with expansion or contraction occurring in all directions. On an average liquids expand about ten times as much as solids and gases expand much more than liquids.

$$\text{Volume expansion} = \frac{V_2 - V_1}{VX(T_2 - T_1)}$$

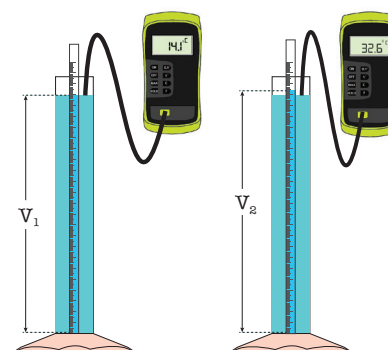

34. Heat Conduction and Convection*

Light up the spirit light; take any two metal rods on both of your bare hands. The distance from one end of rod to your hand holding position should be equal for both metals. The rod which was held by your hand that feels first heat sensation has higher thermal conductivity compared to another on your hand.

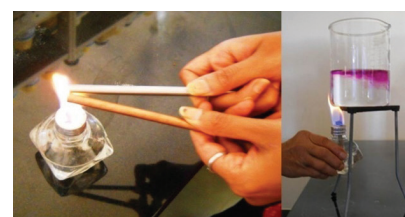

35. Specific heat of liquid*

When a current I is passing through a resistor for a period of time, the electrical energy can be converted in to heat energy follows Joules heating. If the resistor is inside a liquid medium, then, this heat energy form electricity can in turn rise the temperature of the liquid.

$$C_p = \frac{(I^2 X R X t) - (M_c X C_{p \text{ glass}} X \Delta T)}{M_w X \Delta T}$$

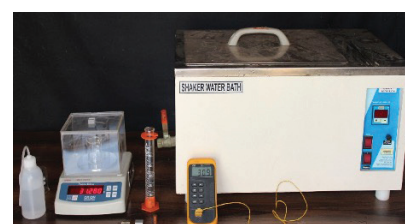

36. Specific heat of metals*

Specific heat capacity (C_p) is defined as the amount of heat energy required to raise 1 kg mass of the object by 1 K. Its S.I. unit is $\text{Jkg}^{-1}\text{K}^{-1}$.

Take a clean, dry glass beaker. Mass of the beaker = (M_g). Add 20 mL of water to the beaker and find the mass M_w of 20 mL water. Note down the initial temperature T_1 of water. You are given Fe, Cu and Al rods. Metal rods are kept in a constant temperature water bath for more than 30 minutes. Note down the temperature T_2 of the water bath in which the rods are immersed. Take metal and drop it in the beaker containing 20ml of water. Find the maximum temperature T_3 reached. Find the mass M_m of metal after measuring the T_3 .

Specific heat capacity of metal,

$$C_p = \frac{(M_w \times C_{pw} + M_b \times C_{pG}) \times (T_3 - T_1)}{M_m \times (T_2 - T_3)}$$

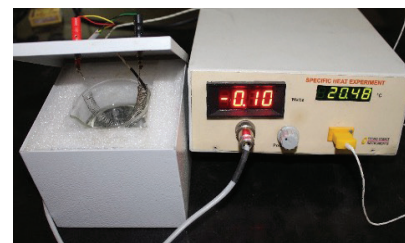

37. Latent heat of fusion of ice*

If we supply heat to a solid ice then it can convert from solid state to liquid state without changing its temperature. The heat energy released or absorbed by an object during a thermodynamic process without changing its temperature is called latent heat. Ice changes its phase to water at 0°C . Latent heat of fusion or enthalpy of fusion of ice is the amount of heat released per kg of ice.

38. Newton's law of cooling*

According to Newton's law of cooling the rate of heat loss of a hot body is proportional to the difference in temperature between the hot body and its surroundings.

$$\log(T_{\text{body}} - T_{\text{surr}}) = -kt + C$$

Where T_{body} = hot body temperature;

T_{cur} = surrounding temperature; t = time.

The room temperature is noted. Take a 250mL glass beaker, fill it with hot water. The temperature is noted and the timer is started. The variation in temperature is noted as function of time. The observations are tabulated and a graph is plotted with $\log(T_{\text{body}} - T_{\text{surr}})$ on the Y axis and time on the X axis. A straight line is obtained. Find the slope which gives the value of k .

39. Enthalpy of neutralisation

Enthalpy of neutralisation of Sodium hydroxide and sulphuric acid is determined by measuring the temperature rise during the reaction.

Therefore, heat of neutralisation per mole
 $= (M_1 C_{PG} + M C_{PW}) \Delta T \times 20.$

**40. Determination of ΔH° and ΔS° of CaO-H₂O system**

From the titration experiment with saturated solutions, calculate the values of K_{SP} at two temperatures using the relation:

$$K_{SP} = 4x^3, \text{ where } x = [Ca^{2+}]$$

Equilibrium constant, K, at a given temperature, T, is related to the standard free energy change, ΔG° , of the corresponding reaction at that temperature by the relation,

$$\Delta G^\circ = -RT \ln K$$

Calculate ΔG° at two different temperatures. ΔG° at a given temperature, T, is related to standard enthalpy of reaction, ΔH° , standard entropy of reaction, ΔS° and T by the relation:

$$\Delta G^\circ = \Delta H^\circ - T\Delta S^\circ$$

**41. Variation of vapour pressure of water with temperature**

Study of the variation of water vapour pressure as a function of temperature. Therefore, it is ideal to evacuate the air in the apparatus to less than 1 mbar and then introduce water into the glass bulb. This is done to eliminate additional pressure exerted by air due to increase in temperature. As the water introduced is in vacuum the pressure inside glass bulb is a direct measure of water vapour pressure at that temperature.

The variation of Vapour pressure of water with respect to temperature was plotted. The decrease in vapour pressure of water on addition of salt was observed and verified.

42. Determination of latent heat of vaporisation using Clausius–Clapeyron equation*

Clausius-Clapeyron equation is given as,

$$\ln P = \frac{-L}{RT} + C$$

P is the vapour pressure, C is constant, R is gas constant and L is latent heat of vaporisation. Plot $\ln P$ vs $1/T$. Determine the slope of the straight line obtained and calculate the latent heat of vaporisation of the liquids using Clausius-Clapeyron equation.

Electrochemistry

43. Measurement of conductivity and pH of HCl

Pipette out 25 mL of Na_2CO_3 solution into a 250 mL conical flask. Add 3 drops of methyl orange indicator. Titrate against the 0.1M HCl taken in the burette. Using agreeing value, calculate the exact normality of the HCl solution. Calculate the volume of the standardised HCl required for the preparation of 100 mL of 0.01 M HCl. Prepare the 0.01 M HCl solution in a 100 mL volumetric flask. Now prepare 0.001 M, and 0.0001 M HCl solutions in two separate 100 mL volumetric flasks. Measure the pH and conductivities of the 0.01 M, 0.001 M and 0.0001 M HCl solutions. Measure the pH and conductivities of the 0.1 N Na_2CO_3 solution. Report the results.



44. Conductivity and pH measurements of NaOH

Pipette out 10 mL of the NaOH solution into a 100 mL conical flask. Add 3 drops of phenolphthalein indicator. Titrate against the previously prepared standard ~ 0.1 HCl taken in the burette. Using agreeing value, calculate the exact normality of the NaOH solution. Calculate the volume of the standardised NaOH solution required for the preparation of 100 mL of 0.01 M NaOH. Prepare the 0.01 M NaOH solution in a 100 mL volumetric flask. Now prepare 0.001 M, and 0.0001 M NaOH solutions in two separate 100 mL volumetric flasks. Measure the pH and conductivities of 0.01M, 0.001 M and 0.0001 M NaOH solutions. Report the results.



45. pH titration of HCl with NaOH - Determination of concentration of NaOH solution

Carry out a fast titration with addition of 1 mL of NaOH to HCl in each step. After each addition, wait for ~ 10 seconds. Then note down the pH value. Note the approximate equivalence point. Repeat the titration, but with smaller steps of NaOH addition near the equivalence point. Continue the titration a few steps beyond the equivalence point. Using the values of second titration, plot a graph of pH vs. volume of NaOH.

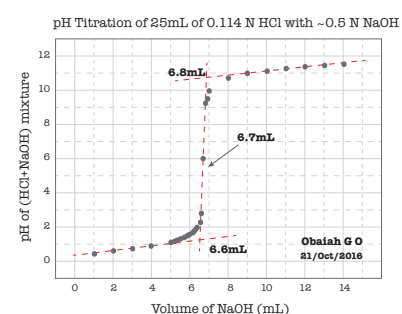

46. Calculation of Pka_1 , Pka_2 and Pka_3 by the titration of Phosphoric acid with NaOH using pH meter

Carry the pH metric titration of Phosphoric acid and NaOH.

Here, pH corresponds to half neutralisation point gives pK_a . Similarly calculate the values of pK_a_2 and pK_a_3 using the plotted graph.

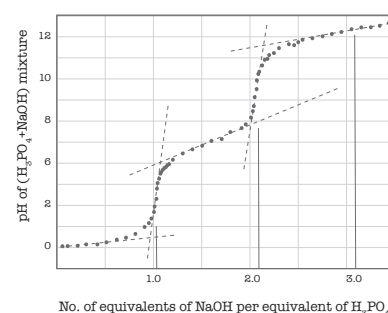

47. Determination of pK_a of Glycine

pK_a of glycine can be determined by the pH titration of Glycine and NaOH. Two pK_a are obtained.

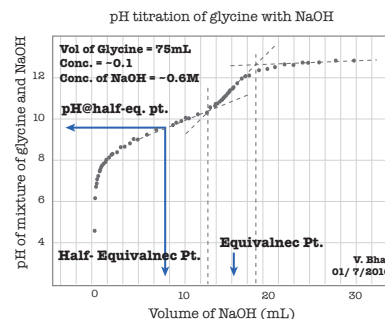

48. Preparation and testing the buffer action of Phosphate buffers

Phosphate buffers can be prepared by mixing Sodium dihydrogen phosphate and disodium hydrogen phosphate. By using Henderson equation pH of solution also adjusted with concentration of components. Buffer action was checked by titrating against HCl and NaOH separately.

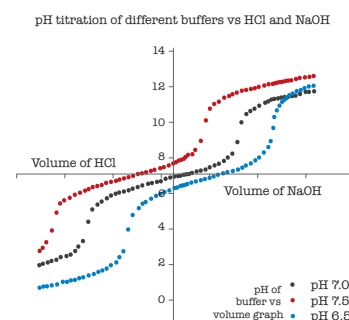

49. Preparation and testing buffer actions of NH_3-NH_4Cl buffers

This buffer can be prepared by aqueous ammonia and ammonium chloride. This is a basic buffer, so tested by using an acid.

50. Determination boiling point elevation constants

Calculate the molal boiling point elevation constant, K_b , for water using the equation:
 $K_b = \Delta T_b \times c_m$ For that, boiling point of pure water and salt water of known concentration was determined.

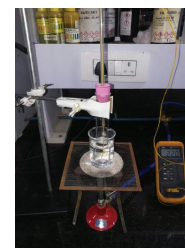

51. Determination of molal freezing point depression constant of water using NaCl as solute

Freezing point of the pure water was determined by cooling the water with freezing mixture. Similarly, find the freezing point of a solution containing exactly 1.461 g of NaCl and 25 mL of water. Calculate molal freezing point depression constant (ΔT_f) of water using the relation: $\Delta T_f = K_f \times c_m \times i$

Here, c_m is the molality of NaCl solution. Assuming complete ionisation, molality of particles in water would be twice the molality of NaCl. So, $i = 2$ for NaCl.

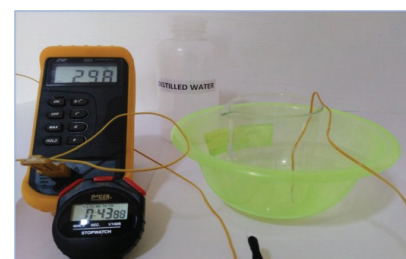

52. Boiling point variation with composition – Deviation from Raoult's law*

Boiling point of different composition of water and acetone was determined. Plot boiling point verses mole fraction of acetone.



53. Boiling point variation with composition of ethanol-water system*

Boiling point of different composition of water and ethanol was determined. Plot boiling point verses mole fraction of ethanol.

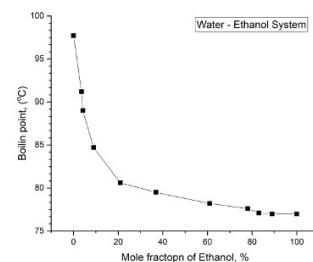

54. Determination of osmotic pressure and Reverse Osmosis-Issues of Drinking water*

By using semipermeable membrane osmosis can be achieved. But tap water was purified by reverse osmosis technique. $\pi V = n R T$

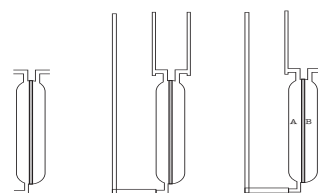

55. Conductometric titration of HCl with NaOH

Conductometric titration also give neutralisation point of reaction of acid and base. HCl and NaOH was titrated conductometrically and conductance versus volume of NaOH plotted to get equivalence point.



56. Determination of Equivalent Conductance at infinite dilution of a strong electrolyte*

Equivalent conductance at infinite dilution of strong electrolyte was determined by diluting the sample and noted down the corresponding conductance. It is linear change as the concentration decreases conductance also decreases. By extrapolating the graph of conductance versus square root of concentration λ_0 was calculated.

57. Kohlrausch law*

The law says that every ion contributes to the conductance of an electrolyte in the limit of infinite dilution, regardless of the presence of other ions; the equivalent conductance of a very dilute solution of a strong electrolyte is a linear function of the concentration.

Accordingly, the equivalent conductance of acetic acid, a weak electrolyte cannot be determined directly. Hence it is calculated as the sum of conductance of constituent ions – CH_3COO^- and H^+

$$\lambda_0[\text{CH}_3\text{COOH}] = \lambda_0[\text{CH}_3\text{COO}^-] + \lambda_0[\text{H}^+]$$

Therefore,

$$\lambda_0[\text{CH}_3\text{COOH}] = \lambda_0[\text{CH}_3\text{COONa}] + \lambda_0[\text{HCl}] - \lambda_0[\text{NaCl}]$$

$$\lambda_0[\text{CH}_3\text{COOH}] = \lambda_0[\text{CH}_3\text{COO}^-] + \lambda_0[\text{Na}^+] + \lambda_0[\text{H}^+] +$$

$$\lambda_0[\text{Cl}^-] - \lambda_0[\text{Na}^+] - \lambda_0[\text{Cl}^-]$$



58. Ostwald's Dilution Law: Determination of Dissociation Constant of Weak Acid*

Weak electrolytes are only partially dissociated in solution. Hence, for such electrolytes the dissociation constant, K is given by the Ostwald's dilution law as $K = c\alpha^2 / (1-\alpha)$ where c is its molar concentration and α is the degree of dissociation.

Prepare 0.05, 0.025, 0.0125, 0.00625M of the acetic acid solution by accurately diluting the given 0.1M stock solution. Measure the specific conductance of each of the prepared solutions using conductometer. Then calculate equivalent conductance, degree of dissociation and dissociation constant.

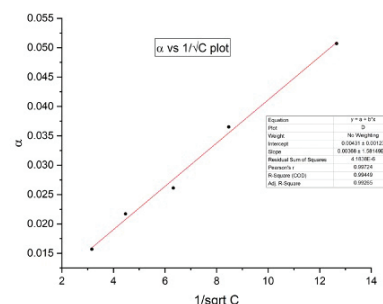

59. Precipitation Titration and Solubility of sparingly soluble salt

Solubility of sparingly soluble salt can be determined by precipitation titration conductometrically. BaSO₄ was precipitated by the reaction of BaCl₂ and sodium sulphate. Solubility = 1000 K/λ₀

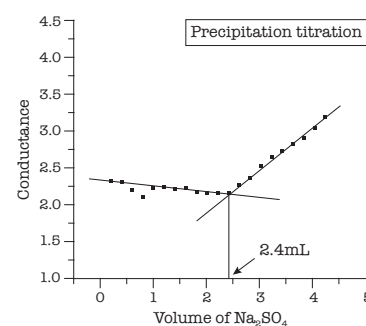

60. Titration of a mixture of strong and weak acid with a strong base

Upon adding a strong base to a mixture of a strong acid (HCl) and weak acid (CH₃COOH), the following reaction occurs sequentially.

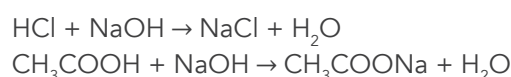

Pipette out 10 cm³ of the given HCl solution and 5cm³ of acetic acid solution into a clean beaker. Add sufficient water to dip the probe. Fill the burette with the standard NaOH solution (a micro- burette is preferable). A small aliquot (say 01 cm³) of NaOH solution is added to the acid mixture, the solution is stirred well with a glass rod and the conductance is noted. Continue the addition of the base and measure the concentration until the three limbs of the graph Figure are traced fully.

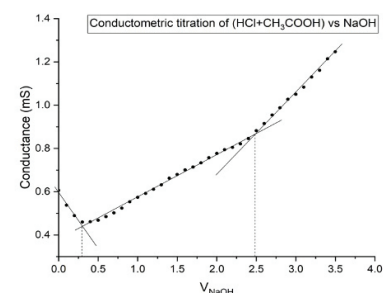

61. Determination of solubility product for AgCl, AgBr and AgI

Take two 100 mL beakers and cleaned Ag electrodes. Take the 0.1 M AgNO₃ solution in one beaker and another beaker 0.1 M KCl separately. Connect both the beakers with salt bridge, and to the KCl solution add one drop of AgNO₃ solution then measure the potential of cell employing a multimeter. It is in mV.

$$E = 0.059 \log \left(\frac{[\text{Ag}^+]_{\text{AgNO}_3}}{[\text{Ag}^+]_{\text{AgCl}}} \right) = [\text{Ag}^+] [\text{Cl}^-]$$

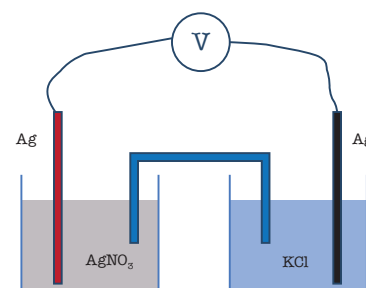

**62. Determination of electrode potentials
Measurement of potentials – Daniell cell**

Electrolytic solutions of different concentrations are prepared for respective electrode. Electrode potentials are measured with reference to standard calomel electrode. Calculate E_0 against standard hydrogen electrode (SHE),
 E_0 (vs SHE) = $E_{\text{cell}} - 0.242$ (V)

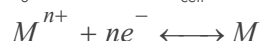

$$E = E_0 - \frac{2.303}{nF} \log \frac{1}{[M^{+n}]}$$

63. Daniell Cell

Dip Zn in 0.1 M $\text{Na}_2\text{SO}_4 + 1.0$ M ZnSO_4 ,
 Cu in 0.1 M $\text{Na}_2\text{SO}_4 + 1.0$ M CuSO_4 ,
 Ag in 0.1M $\text{Na}_2\text{SO}_4 + 1.0$ M AgNO_3 and
 Ni in 0.1M $\text{Na}_2\text{SO}_4 + 1.0$ M NiSO_4 .

Combine these half cells by a salt bridge with different combinations. Measure the voltage between electrodes. The cell voltage measured is the Daniell cell Voltage. Compare your value of Daniell cell voltage with the expected value.

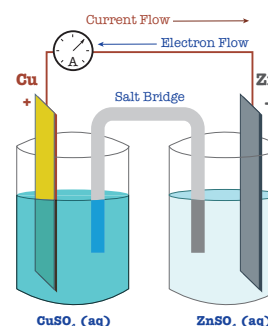

64. Battery charge-discharge cycling

Circuit diagram for charging:

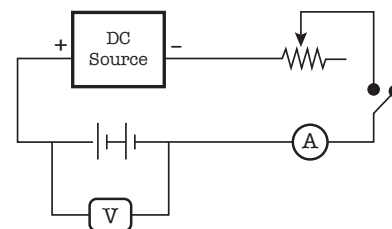

Circuit diagram for discharging:

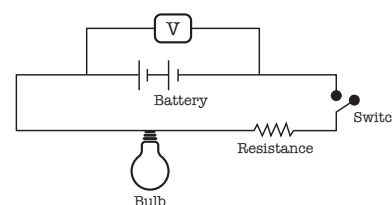

65. Determination of Avogadro number*

The experiment of electrode position of copper is used to determine Avogadro number. A known quantity of electricity is passed through copper sulphate solution using copper plate as anode and stainless steel as cathode. The mass of copper deposited is proportional to the quantity of electricity passed.

The reaction is given by: $\text{Cu}^{2+}(\text{aq}) + 2e \rightarrow \text{Cu}(\text{s})$
 (At -ve electrode) (reduction)
 $\text{Cu}(\text{s}) \rightarrow \text{Cu}^{2+}(\text{aq}) + 2e$
 (At +ve electrode) (oxidation)



66. Estimation of KMnO_4 in the given solution by titrating against standard oxalic acid

This is called a redox titration. The oxidising agent oxidises the reducing agent and in the process, gets reduced. Potassium permanganate with Mn in +7 oxidation state - is an oxidising agent in acidic medium and during the process gets reduced to Mn in +2 oxidation state. Reducing agents here is oxalic acid which reacts with potassium permanganate in presence of dil. sulphuric acid. Potassium permanganate itself serves as an indicator as it is intensely coloured.

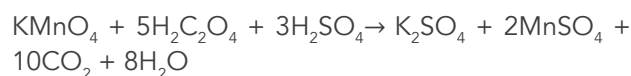

67. Estimation of ferrous ammonium sulphate by titrating against standard KMnO_4

This is also a redox titration involving potassium permanganate. The reducing agent here is ferrous ammonium sulphate, also known as Mohr's salt $(\text{NH}_4)_2\text{SO}_4 \cdot \text{FeSO}_4 \cdot 6\text{H}_2\text{O}$.

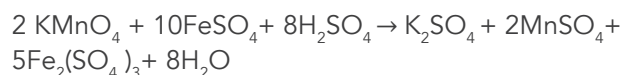

68. Estimation of ferrous ammonium sulphate in the given solution by titrating against standard Potassium dichromate solution

Potassium dichromate, like potassium permanganate is also an oxidising agent. It oxidises Mohr's salt solution in acidic medium, according to the following equation,



69. Estimation of Iron using Potassium dichromate by potentiometric titration

Take 25 mL of given FAS solution in a beaker. Take sufficient volume of distilled water such that the electrodes are dipped in the solution. Add about 2 mL of conc. H_2SO_4 in to the solution. Place the platinum electrode in the solution and connect it to a saturated calomel electrode by means of salt bridge. Now add 1 mL of 0.05 N $\text{K}_2\text{Cr}_2\text{O}_7$ solution from the burette and record the emf of the cell. The solution should be stirred thoroughly before measuring the emf. Go on adding $\text{K}_2\text{Cr}_2\text{O}_7$ solution and note down the emf after stirring. Plot EMF vs volume of $\text{K}_2\text{Cr}_2\text{O}_7$ added in mL.

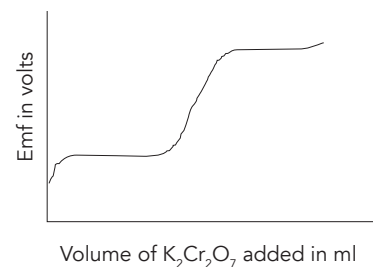

70. Complementary colours - Correlation of absorption spectra to colours

Absorption spectra of some coloured compounds are recorded and correlated its colour into absorption band.

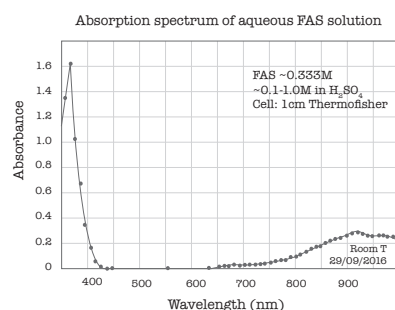
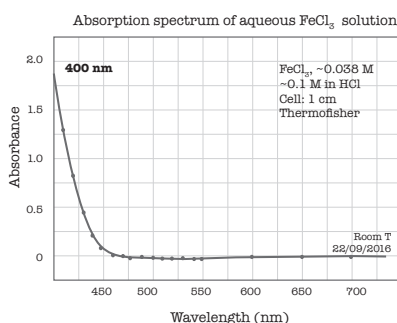
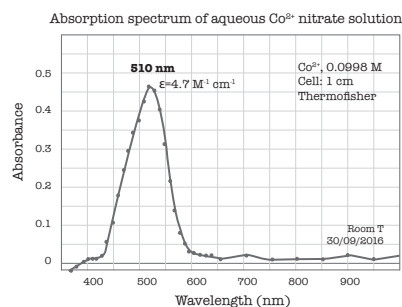
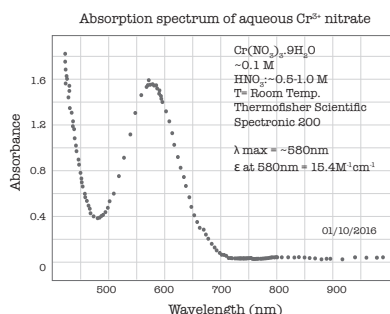

71. Beer-Lambert's Law

a). Verification of Beer Lambert law

Different concentrations of $[\text{FeSCN}]^{2+}$ was prepared and absorbance was noted down at the wavelength of 447 nm. Plotted a graph of absorbance versus concentration which is a straight line. Slope gives the molar extinction coefficient.

b). Beer Lambert law – Determination of Molar Extinction Coefficient*

In the similar way, absorption coefficient of KMnO_4 and MnCl_2 are determined

c). Experiment: Allowed and forbidden transitions UV-Visible absorption spectra of KMnO_4 and MnCl_2 in aqueous solutions

Taking distilled water as reference, record the absorption spectra of the two solutions separately in the 400–700 nm range.

By comparing the extinction coefficient value, we can decide whether the transition is allowed or forbidden.

UV-Vis Absorption spectrum of $7.3 \times 10^{-4} \text{ M KMnO}_4$, in water

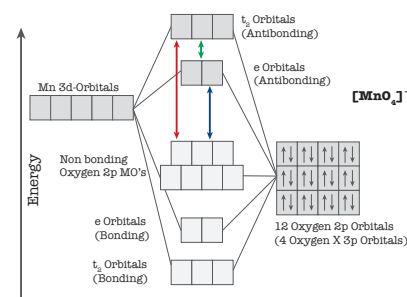
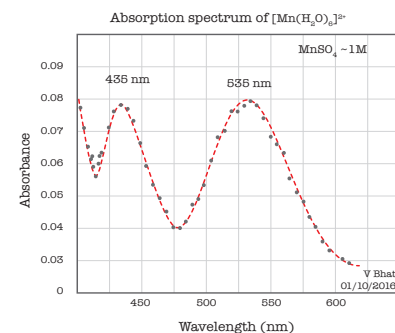
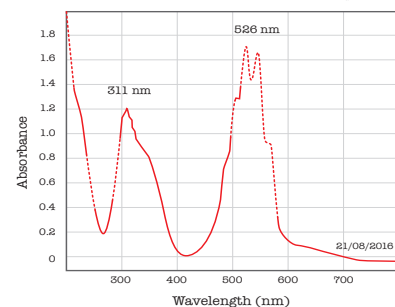

72. UV-Visible absorption spectra of d¹ systems

Absorption spectra of [Ti(H₂O)₆]³⁺ and VOSO₄ taken as examples for d¹ system. In d¹ system, only one electron in the d orbital. So, the electronic transition is from t_{2g} to e_g orbital.

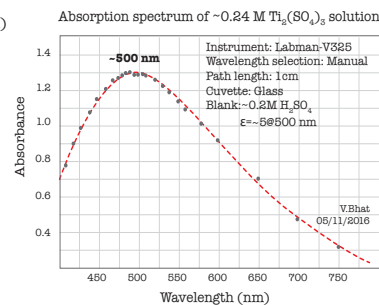
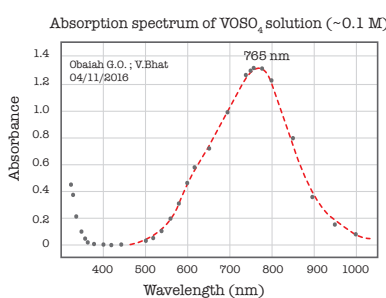

73. Calculation of 10Dq for d⁹ systems

Copper in +2 oxidation state belongs to d⁹ system. Absorption spectra of [Cu(NH₃)₄(H₂O)₂]²⁺ and [Cu(H₂O)₆]²⁺ recorded and calculated the 10Dq.

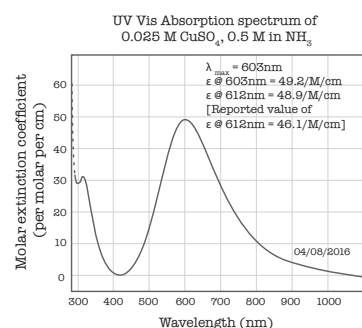
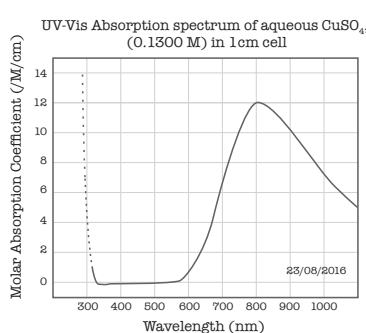

74. Weak field and strong field ligands

In this experiment, Ni²⁺ ion taken along with different ligands. Recorded the absorption spectra of Ni²⁺ with H₂O, NH₃ and ethylene diamine as ligand.

The lowest energy transition in Ni²⁺ complex is from ³A_{2g} to ³T_{2g}. By varying the ligand absorption maximum shifts depending on the ligand strength.

75. Molecular orbital energy level diagram

In the MO energy level diagram of [MnO₄]⁻, fill the molecular orbitals with the available electrons, applying general electron-filling rules. Assign the peaks with reference to molecular orbital energy level diagram of [MnO₄]⁻.

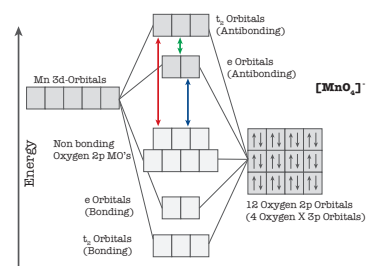
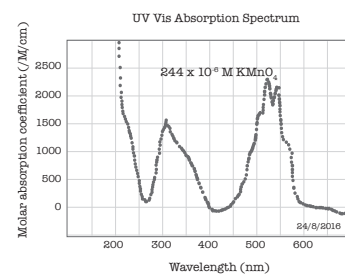

76. Ligand to Metal Charge Transfer Spectra*

Coloured ions like chromate and dichromate are d^0 systems. But there will be electronic transition from ligand orbital to empty orbitals of metal which gives colour. This is known as ligand to metal charge transfer spectra.

Absorption spectra of chromate and dichromate are recorded and assigned the peaks corresponds to the respective charge transfer transition.

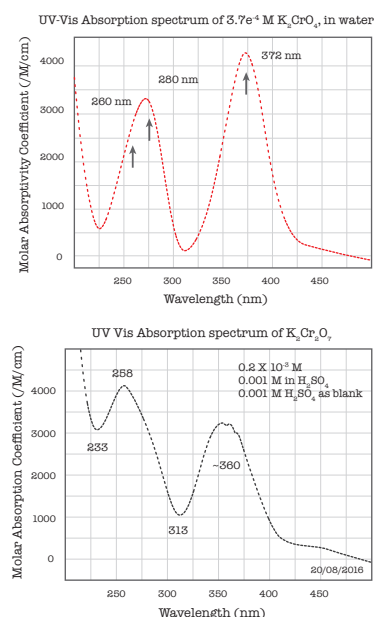

77. To determine the formula of a complex spectro-photometrically by continuous concentration variation*

In this experiment, the sum of the total analytical concentrations of the ligand, C_L and metal ion, C_M is kept constant and only their ratio is varied. i.e., $C_L + C_M = C$. A wavelength is selected where the complex absorbs strongly and the ligand and metal ions do not. A plot of the mole fraction of the ligand ($C_L / (C_L + C_M)$) in the mixture vs. absorbance gives a triangular shaped curve. The legs of the triangle are extrapolated until they cross. The mole fraction at the intersection gives the formula of the complex.

78. Friedel-Craft Alkylation*

Preparation of Starting material: t-butyl chloride from t-butyl alcohol:

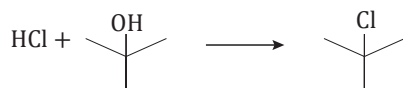

By using this Friedel-Craft alkylation of toluene was carried.

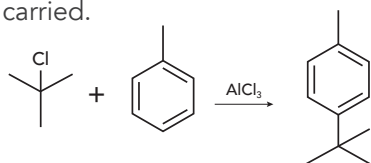

79. Oxidation of Benzhydrol to Benzophenone*

Oxidation of benzhydrol to benzophenone by using Sodium hypochlorite as oxidising agent and tetrabutyl ammonium bisulphate as phase transfer catalyst. Completion of the reaction can be confirmed by TLC.

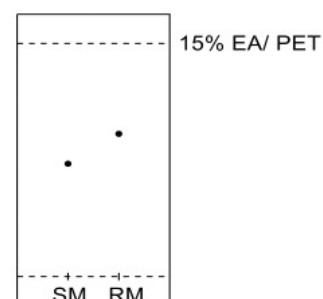
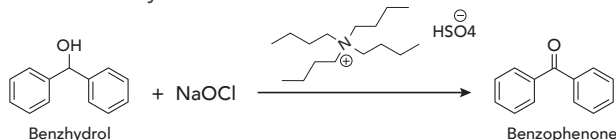

80. Reduction of Acetophenone*

Reduction of acetophenone to phenyl ethanol by using sodium borohydride as reducing agent in methanol as solvent. Completion of the reaction can be confirmed by TLC.

**81. Synthesis of Dibenzylidene Acetone – A typical Aldol Reaction***

Carbonyl compound with α -hydrogen undergoes condensation to form aldol in presence of base is called aldol condensation.

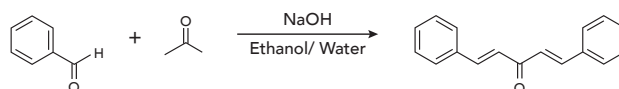
**82. Synthesis of p-nitro acetanilide by nitration of acetanilide***

Nitration of acetanilide by using mixture of nitric acid and sulphuric acid as nitrating agent to form p-nitro acetanilide.

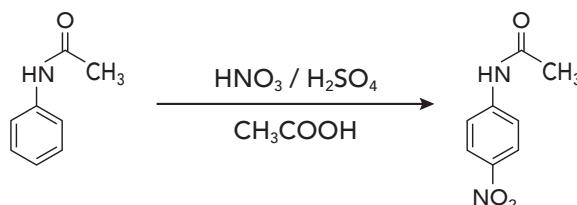
**83. Synthesis of N-methyl benzamide***

Synthesis of amide from acid by using CDI and methylamine.

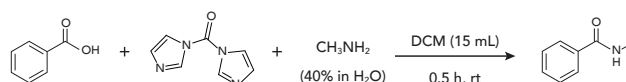
**84. Thin layer chromatography***

Thin layer chromatography (TLC) is a chromatography technique used to separate mixtures, monitor the reaction progression, identify compounds present in a given mixture, and determine the purity of a substance. Thin layer chromatography is performed on a sheet of glass, plastic, or aluminium foil, which is coated with a thin layer of adsorbent material, usually silica gel, aluminium oxide, or cellulose (blotting paper).

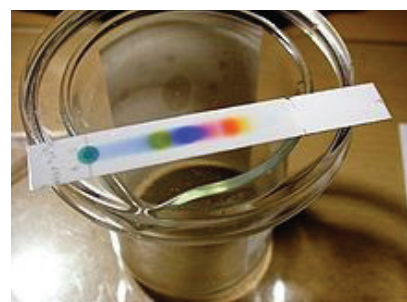

85. Column chromatography*

Column chromatography is one of the most useful techniques for purifying compounds. This technique utilises a stationary phase, which is packed in a column, and a mobile phase that passes through the column. This technique exploits the differences in polarity between compounds, allowing the molecules to be facily separated. The two most common stationary phases for column chromatography are silica gel (SiO_2) and alumina (Al_2O_3), with the most commonly used mobile phases being organic solvents. The solvent(s) chosen for the mobile phase are dependent on the polarity of the molecules being purified.

**86. Qualitative analysis of Organic Compounds***

Detection of elements other than carbon present in the compound. Identification of nature of carbon skeleton and functional group analysis by simple chemical reactions carried.

**87. Indexing an XRD pattern
Determination of Density by X-ray method***

Here we will show how to find lattice parameter of metals crystallising in cubic structures. Powder X-ray diffraction pattern is recorded in a diffractometer and the diffraction lines are indexed. From the indexed pattern, lattice parameter, packing fraction, atomic radius, density of metals such as Al, Fe, Pt, Cu and also compounds such as NaCl and many other compounds are obtained.

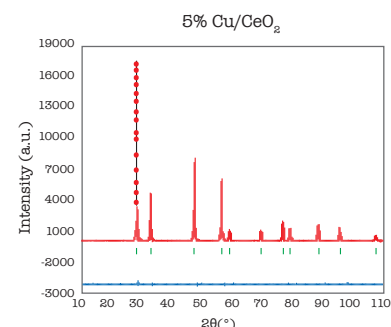
**88. Growing crystals***

Grow crystals following the instruction in the laboratory. Observe the crystal shapes under the microscope.

**89. Determination of linear dimensions and density of solids and liquids**

Density = Mass / Volume

Density of regular shaped solids are determined by measuring its linear dimensions by using digital vernier calipers.

Density irregular shaped solids are determined by buoyancy method.

Density = Mass in air / Mass in water

Density of liquids is determined easily by using pipette and weighing balance.



90. Temperature coefficient of resistance, α , of metal*

Resistance of a metal like Cu increases with increasing temperature. Resistance of metals increases with increasing temperature. Find the variation in resistance of Cu wire with temperature. Dip the copper coil in the hot water bath and measure the resistance of the coil as the water cools as a function of temperature till room temperature.

$$\alpha = \frac{(R_2 - R_1)}{(T_2 - T_1)R_0}$$

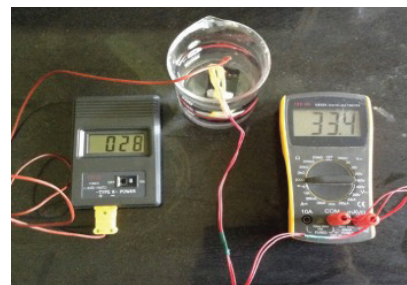

91. Temperature Dependence of Resistance of semiconductor – Determination of Energy Bandgap E_g

Based on the electrical properties, materials can be divided into three classes - (1) metal- good conductor of electricity; (2) insulator- Bad conductor of electricity and (3) semiconductor- electrical conductivity between that of a conductor such as copper and that of an insulator such as glass. Semiconductors are the basic blocks of today's electronics. Unlike metals, the electrical resistivity of a semiconductor material decreases with increasing temperature.

$$\ln(R) = \ln(R_0) + \frac{E_g}{2kT}$$

92. Water of crystallisation and formula of a hydrated salt

In this experiment, a known mass of hydrated copper(II) sulphate is heated to remove the water of crystallisation. The mass of water is found by weighing before and after heating. This information is used to find x in the formula $\text{CuSO}_4 \cdot x\text{H}_2\text{O}$



93. Verification of Langmuir adsorption isotherm

When a component of a heterogeneous system without penetration into another component remains attached on the surface of it, then this phenomenon is called adsorption. The adsorption isotherm is the relation between the pressure (for gases) or concentration (for liquids) of the adsorbate (acetic acid) and its amount adsorbed on adsorbent (charcoal) at a constant temperature. Plot X/m Vs concentration.

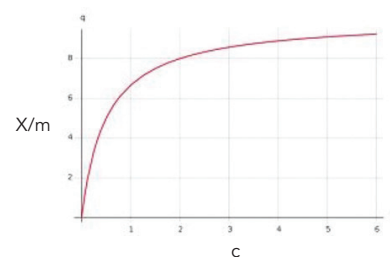

94. Kinetics measurement of acid catalysed Ethyl acetate hydrolysis



Acid hydrolysis of ethyl acetate follows first order kinetics. By titration method concentration was noted as function of time.

Plot $\ln(C_t - C_0)/(C_\infty - C_0)$ versus time, slope gives the rate constant of the reaction.

95. Kinetic measurement of hydrolysis of t-butyl chloride*

This experiment carried conductometrically. As the hydrolysis proceeds conductance of solution increases due to the formation of HCl. Plot $\ln [(K_a - K_t) / (K_a - K_0)]$ vs time t.

Find the slope for the straight line. Slope is the rate constant of the reaction. Repeat the experiment for low temperature and find out the rate constant. Then, activation energy can be calculated by the formula,

$$\ln \frac{k_2}{k_1} = \frac{E_a}{R} \left[\frac{1}{T_1} - \frac{1}{T_2} \right]$$

Where, k_1 and k_2 are rate constants at temperatures $T_1(K)$ and $T_2(K)$ respectively.

96. Kinetics of Oxidation of Alcohol by Potassium Dichromate – Spectrophotometry*

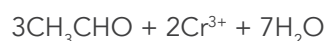

The reaction is first order in each of the reactants. As the reactant, $Cr_2O_7^{2-}$ is coloured and it disappears in the course of the reaction, its concentration may be followed with time using a spectrometer at 420 nm, the wave length at which $Cr_2O_7^{2-}$ obeys Beer-Lambert's law.

Plot the graph of $\ln(A_0/A_t)$ versus time. The calculated slope for the straight line is the rate constant (k_1) of the reaction.

PUC BIOLOGY EXPERIMENTS

1. Microbiological Tools

Petri plates: Petri plates are a pair of dishes, with an upper lid slightly bigger than that of the lower lid, overlapping each other, restricting the contaminants to pass inside. They are made up of borosilicate glass or plastic. Petri plates are of various sizes. They can be sterilised by autoclaving.

Inoculation Loop and needle: An important tool in microbiology used to transfer bacteria and fungi into the medium aseptically. It is made up of Nichrome wire and is circled at the tip. It can be sterilised by heating over a flame to red hot condition.

L-shaped rod: As the name suggests, L- shaped glass rod is 'L' in shape. They are made up of glass or plastic which can be sterilised by incineration or autoclaving respectively. L-shaped rods are used to spread the sample on the solid medium in Petri plates.

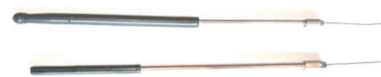

2. Microscopy

Binocular Compound Microscope: The compound microscope uses lenses and light to enlarge the image. It is also called an optical or light microscope. The simplest optical microscope is the magnifying glass and is good to about ten times (10X) magnification. The compound microscope has two systems of lenses for greater magnification. The first one is the ocular or eyepiece lens (10X) that the observer looks into it and the second one is the objective lens, one closer to the object with different magnification power (4x, 10x, 40x and 100x), so that the total magnification power will be 1000X.

Dissecting microscope: Dissecting microscope is an optical microscope variant designed for low magnification observation of a sample, typically using light reflected from the surface of an object rather than transmitted through it.

Stereo binocular microscope: A stereo microscope is an optical microscope that functions at a low magnification. It works by using two separate optical paths. It is ideal for examining surfaces view of solid materials.

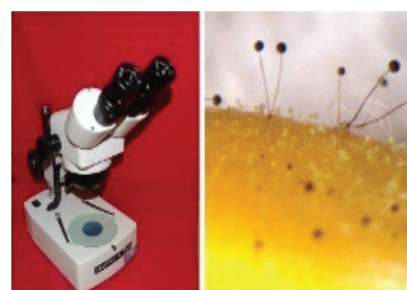
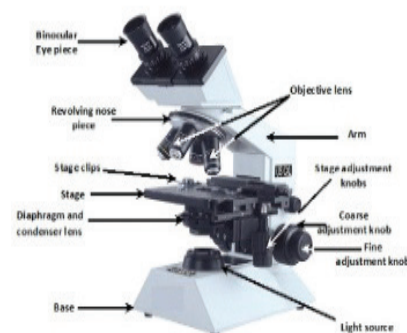

3. Microbiological Sterilisation Methods

Sterilisation is a process of complete physical elimination or inactivation of all living cells in an environment. Sterilisation is achieved by exposing material to lethal agents like physical, chemical or ionic in nature. In case of liquids, physical elimination of cells from the medium is done. Selection of a method depends on the desired applicability, efficiency, toxicity, ease of use, availability, cost and effect on the properties of the object to be sterilised. The agents commonly used for sterilisation are heat (dry or moist heat), chemicals (alcohol, aldehydes), ultra-filters (0.2 or 0.45 μ m syringe filter) and radiations (UV).

4. Preparation of culture media

Microorganisms like all other living organisms, require basic nutrients for their sustenance of life and reproduction. The food material on which microorganisms are grown in a laboratory is known as Culture medium. Ingredients of a culture medium depend on the type of microorganism desired to be grown. Agar in a culture medium acts as solidifying agent which liquefies at 100°C and solidifies at 40°C. The medium without any solidifying agent is known as 'Liquid medium or Broth'. Nutrient Agar media (NA) for isolation of bacteria and Potato Dextrose Agar (PDA) for fungi are generally used.

5. Isolation of Microorganisms from Natural Sources

When the sample from natural sources is inoculated on to a nutrient medium, microorganisms present in the sample multiply rapidly and form distinct colony of their own. The media generally used are Nutrient Agar (NA) for isolation of bacteria and Potato Dextrose Agar (PDA) for fungi. Chloramphenicol is added to PDA media to prevent growth of bacteria.



6. Study of Colony Characteristics of Bacteria

The cultural characteristics of an organism pertain to its macroscopic appearance on a medium. The colony morphology of an organism depends on type of media used and other growth conditions provided. Descriptive terms must be used in recording cultural characteristics.

7. Preparation of Bacterial Smear

To study the size, shape, arrangement and structure of bacterial cells, they are first fixed on a glass slide using heat and stained to make them more readily visible. A properly prepared bacterial smear is one which withstands one or more washings during staining without loss of organisms.

8. Simple staining

The use of single stain to colour bacteria is commonly referred to as simple staining. Some of the most commonly used dyes for simple staining are methylene blue, crystal violet and safranin. All of these dyes work well on bacteria because they have colour bearing ions that are positively charged. The fact that bacteria are slightly negatively charged, this results in attraction between cations and the organism. The purpose of simple staining technique is to study cell shape, size and the arrangement of bacterial cells.

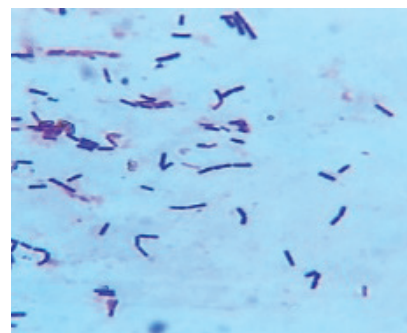
**9. Negative staining**

In negative staining technique a simple stain is used that does not stain the bacteria but stains the background. Nigrosine/India ink, an acidic stain carrying negative charge, is repelled by the bacteria which too carry a negative charge on their surface. Therefore, bacteria cell appears transparent and unstained upon examination. Negative staining provides information about the cell shape and arrangement.

**10. Gram's staining**

The difference in staining responses to the gram stain can be related to chemical and physical differences in bacterial cell wall. The gram-positive bacterial cell wall is thick and chemically simple composed mainly of protein and mucopeptides. When treated with alcohol, it causes dehydration and closure of cell wall pores, thereby not allowing the loss of crystal violet-iodine complex and cells remain purple. In contrast, the gram-negative bacterial cell wall is thin, complex, multilayered structure and contains relatively a high lipid contents, in addition to protein and mucopeptides. The higher amount of lipid is readily dissolved by alcohol, resulting in the formation of larger pores in the cell wall which does not close on dehydration of cell wall proteins, thus facilitating the leakage of crystal violet-iodine complex and resulting in the decolourisation of the bacterium which later takes the counter stain and appears pink in colour.

11. Bacterial catalase test

Most aerobes and facultative anaerobes utilise oxygen for respiration and produce hydrogen peroxide as a metabolic product. The hydrogen peroxide produced is toxic to the cells and hence production of H_2O_2 becomes suicidal. Bacteria have evolved a mechanism of getting rid-off H_2O_2 produced in the cell. The bacteria produce an enzyme called 'Catalase' to breakdown H_2O_2 into water and oxygen. The release of oxygen is indicated by effervescence.

12. Bacterial motility-hanging drop technique

Hanging drop preparation is useful for microscopic examination of living microorganisms to study their motility. Organisms are observed in a drop that is suspended under a cover glass in a cavity slide. Since the drop lies within an enclosed glass chamber, drying occurs very slowly.

13. Slide culture: autotrophs

To make comparative studies of free-living organisms in freshwater lakes, an immersed slide technique devised by A. T. Henrici (1932), that revealed the presence of many organisms. The technique worked well for algae, bacteria and other microorganisms. Method consists of suspending glass microscope slides in the body of water for a specified period of time. Microorganisms in the water adhere to the glass and multiply to form small colonies that are observable under the microscope.

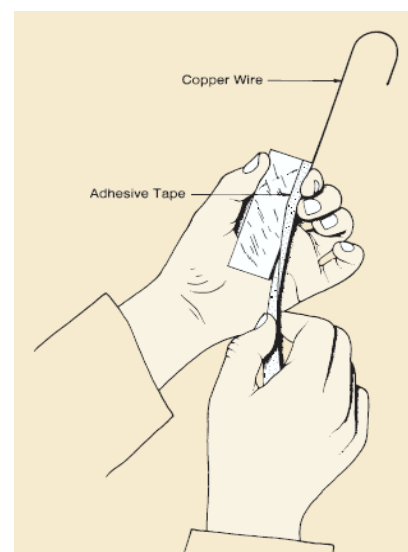

14. Study of cyanobacteria and algae

Cyanobacteria and algae are groups of microscopic unicellular or multicellular organisms which are present abundantly in most of the aquatic ecosystems. Some of them are also seen on barks of trees and in soil. They consist of photosynthetic pigments and produce their own food. Algae are eukaryotic organisms that have distinct, visible nuclei and chloroplasts. The undifferentiated algal structure is referred as a Thallus. Although referred as blue green algae, cyanobacteria are prokaryotic microbes. Cyanobacteria are gram negative bacteria consisting of photosynthetic pigments in granules that are attached to the membrane.

15. Microscopic observations of fungi by tease mount preparation

Fungi are generally microscopic and transparent which makes them difficult to observe. In this technique, fungi are stained using cotton blue stain and mounted in lactophenol to obtain semipermanent microscopic slides. Many of the fungi are themselves coloured known as 'Dematiaceous fungi', which can be mounted using lactophenol solution and observed using a microscope without staining. The tease mount preparation provides a chance for different conidia and hyphae to be observed.

16. Study of fungi

Fungi are eukaryotic microorganisms without plastids. Fungi are unicellular or filamentous consisting of multicellular haploid hyphae with absorptive nutrition. Their cell wall is made up of chitin or β -glucans. The estimated number of fungi is 1.5 million among which only 70,000 species are known till date. Fungi are morphologically diverse group of organisms. Some of the well-known species of filamentous fungi are *Aspergillus* spp., *Penicillium* spp., *Rhizopus* spp., *Alternaria* spp., *Curvularia* spp. and *Drechslera* spp. Fungi also exist in unicellular form commonly known as 'Yeasts'. Fungi are economically important as they are the source of food, medicine and industrial products. They are also well known for causing plant diseases and opportunistic human infections. In addition, fungi are most essential living forms in nature as they involve in the process of decay.

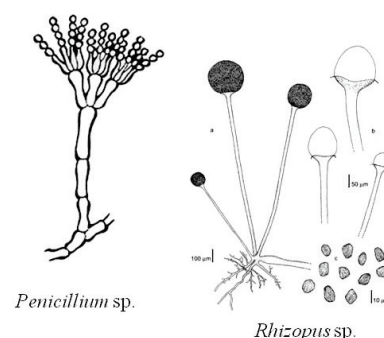

17. Study of lichens

Lichen is the term used to describe symbiotic, mutualistic interaction between fungus and algae/cyanobacteria. They grow on rocks and tree barks. The colour of lichens may vary from white to black through red orange yellow and green. Morphologically, lichens are made up of an algal layer sandwiched between two fungal layers. Not all but only single species of compatible fungus and algae can enter into lichenlike relationship. About 18,000 species of lichens are known till date. There are basically three kinds of lichens: 'Crustose lichen' which is flat and appressed, 'Foliose lichen' which appears leaf like, slightly raised from the surface and 'Fruticose lichen' which is shrub like. Commercially important products from lichens are essential oils used in perfume making and pigments like litmus.

18. Study of protozoa

Protozoa are eukaryotic, generally unicellular life forms which lack cell wall and are motile at some stage of their life cycle. The locomotive organelles of protozoa are pseudopodia, cilia or flagella. Protozoan members are free-living or parasitic in animals. They generally feed upon bacteria and other protozoans. There are some 65,000 species of protozoan members known till date; few of them such as *Entamoeba histolitica*, *Plasmodium* spp. And *Trypanosoma brucei* can cause serious human diseases. Some of the well-known protozoans are *Amoeba*, *Paramecium*, *Euglena* etc.

19. Anatomy of plant cells and tissues

Tissues are group of similar cells, having the same origin and performing a specific function.

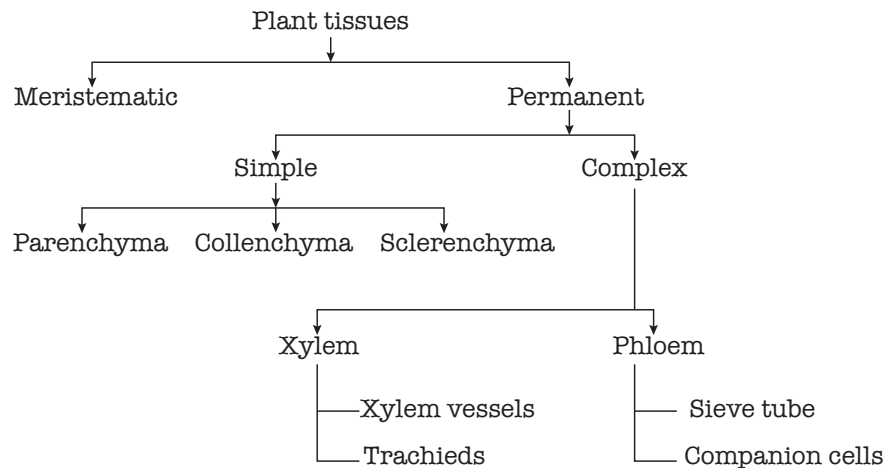

20. Flower morphology and floral diagrams

A flower is the reproductive unit in the angiospermic plants. It is meant for sexual reproduction. A typical flower has four different kinds of whorls namely calyx, corolla, androecium and gynoecium. They are arranged successively on the swollen end of the pedicel called thalamus or receptacle. Calyx and corolla are accessory organs, while androecium and gynoecium are reproductive organs. A flower having both androecium and gynoecium is referred as bisexual flower. A flower having either one of those is called unisexual flower. A flower having all the whorls is known as a 'Complete flower' where as a flower missing any one or more whorl is referred as an 'Incomplete flower'.

Based on the position of calyx, corolla and androecium in respect of the ovary on thalamus, the flowers are described as Hypogynous, perigynous and epigynous.

Position of floral parts on thalamus: (a) Hypogynous (b) and (c) Perigynous (d) Epigynous

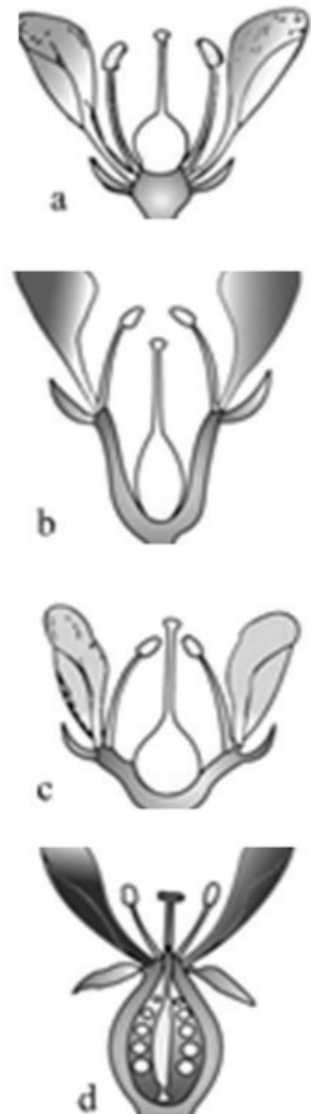

21. Study of cell division

Mitosis: Somatic growth in plants and animals takes place by the increase in the number of cells. A cell divides mitotically to form two daughter cells. The ability of cell to divide is called totipotency. In plants, such divisions rapidly take place in meristematic tissues of root and shoot where the stages of mitosis can be easily observed. In animals, mitotically dividing cells can be easily viewed in the bone marrow cells.

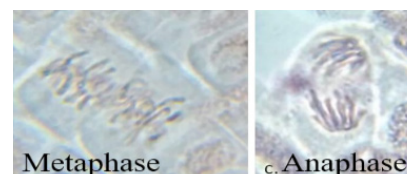

Meiosis: Meiosis, which is referred to as reduction division, is the form of cell division in which a cell divides into four daughter cells each of which has half of the number of chromosomes of the original cell. Meiosis occurs prior to the formation of sperm (in males) and ova (in females). That is - meiosis only occurs in the "gametes". The chromosomes of the grasshoppers have been used for a vast number of cytological studies. These chromosomes present a number of advantages to the cytologist. They are large and relatively few in number. The range of chromosome lengths in the complement is such that each bivalent formed at meiosis can usually be individually identified according to its length. Chiasmata are very clear during diplotene and diakinesis thus allowing analyses of their structure, frequency, distribution and movement. Often the position of the centromere is marked by relatively denser staining (condensation) at early diplotene. Besides these cytological advantages, the techniques involved in the preparation of slides of this material are quick and simple and therefore it is ideal for demonstrating the stages of meiosis to students.

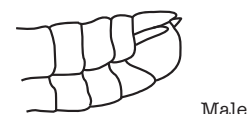
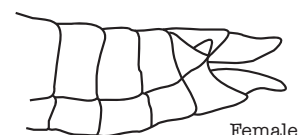

22. Study of animal cells and tissues

Epithelial cells: Epithelium is composed of one or more layers of densely packed cells. In vertebrates, it lines the outer layer of the skin (epidermis), the surface of most body cavities, and the lumen of fluid-filled organs. We can easily mount the epithelial cells which are present at inner wall of the cheek.

Connective Tissue: A tissue, usually of mesoblastic origin, that connects, supports, or surrounds other tissues, organs, etc.

23. Study of Barr body

A Barr body is inactivated (heterochromatinised) X chromosome. It was first observed by Murray Barr in 1949. It is found only in female cells, because those 1 X chromosomes are enough for metabolic activity. It is absent in male somatic cells, because there only 1 X chromosome is present, which is in an active state.

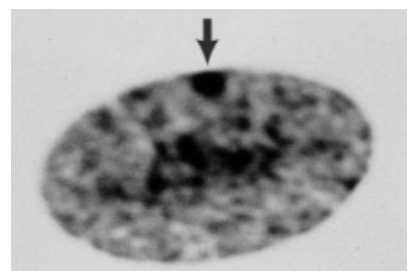
**24. Buffer preparation**

Buffers are aqueous systems that resist changes in pH when small amounts of acid or base are added. Buffer solutions are composed of a weak acid (the proton donor) and its conjugate base (the proton acceptor). Buffering results from two reversible reaction at equilibrium in a solution wherein the concentration of proton donor and its conjugate proton acceptor are equal.

25. Starch hydrolysis

Starch is polysaccharide made up of inter linked, long chains of glucose units. Amylase is an enzyme which hydrolyses starch into maltose and glucose units. Conversion of starch into maltose and glucose can be tested by Benedict's test as starch is a non-reducing sugar whereas both maltose and glucose are reducing sugars.

26. Determination of amylase activity

Every enzyme has maximum activity at optimum temperature and pH. This is unique to every enzyme. Optimum condition for amylase enzyme is pH 7.0 and temperature is around 37° C. Conversion of starch into maltose and glucose can be tested by Benedict's test as starch is a non-reducing sugar whereas both maltose and glucose are reducing sugars.

27. Qualitative analysis for carbohydrates

Carbohydrates prevail widely in nature comprising mono, di, oligo and polysaccharides. Most commonly occurring monosaccharides are glucose, fructose, galactose and ribose. The combination of two monosaccharide units gives rise to disaccharides, for example sucrose, lactose and maltose. Starch, cellulose and pectin are polysaccharides made up of many monosaccharide units. Aldehyde (- CHO) and ketone (= CO) are the active groups in carbohydrates. Carbohydrates contain many hydroxyl groups as well. The chemical property of carbohydrates depends on number of hydroxyl groups, presence of - CHO / = CO group and various acid residues as side chains. These variations are the basis in the development of colour reactions to identify different carbohydrates.

28. Quantitative analysis of reducing sugar by dinitrosalicylic acid (DNS) method	3, 5 – dinitrosalicylic acid, compound is commonly used to estimate the concentration of reducing sugars. The compound is yellow in alkaline condition, which is reduced to 3-amino-5-nitrosalicylic acid when combines with reducing sugar, to give orange red colour.
29. Qualitative analysis for proteins	Proteins are present in the living world, irrespective of the size of the organism, since they form the structural and functional basis of a cell. Proteins are made up of amino acid residues joined by peptide bonds. Proteins react with variety of reagents to form coloured products as they contain peptide bonds. Egg albumin is a glycoprotein soluble in water. Casein is a phosphoprotein present in milk with phosphate group attached to –OH group of serine or threonine residues. Peptone is a source of nutrition for microorganisms made up of short chain of amino acids. Gelatin is also a protein which is used as solidifying agent.
30. Quantitative estimation of proteins by folin – Lowry method	Protein reacts with the Folin-Ciocalteu reagent to give a coloured complex. The colour so formed is due to the reaction of the alkaline copper with the protein as in the biuret test and the reduction of phosphomolybdate by tyrosine and tryptophan present in the protein. The intensity of colour depends on the amount of these aromatic amino acids present and will thus vary for different proteins.
31. Qualitative analysis of lipids	Analyse lipids in the given sample by solubility test, transparency test, emulsification test, test for unsaturation, test for cholesterol and test for free fatty acid.
32. Demonstration of beer-lambert's law	<p>Beer's law: when a beam of monochromatic light enters an absorbing medium, the intensity of light coming out decreases exponentially with the increase in the concentration of light absorbing constituent in the medium.</p> <p>Lambert's law: this law states that, under similar conditions, that the intensity of light coming out decreases exponentially with the increase in the length of the medium through which light passes. Hence, in a colorimeter/ spectrophotometer the absorbance of compound is dependent on concentration. This can be demonstrated by recording the absorption of different concentration of dyes and plot against concentration vs absorption.</p>

33. Study of bacterial growth

Bacterial growth depends on various factors like nutrients, water activity, temperature, pH and osmotic pressure etc. The growth of the bacteria in broth is indicated by increase in turbidity which can be measured using a colorimeter. Temperature and pH affect the activity of microbial enzymes. Osmotic pressure of the medium affects the movement of water across the membrane of bacterial cells thus affecting the rate of bacterial reproduction.

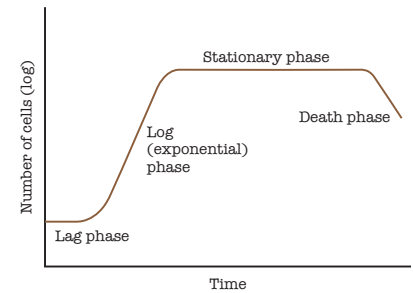

34. Analysis of urine constituents

The quantity and composition of urine reflects various biochemical processes that occur in the body. Thus, the composition of the urine of an individual may change when a person has a disease. In a diseased condition, it is quite common to observe the presence of abnormal constituents or normal constituents in abnormal quantities in the urine.

35. Urine analysis – strip method

Normal urine contains only traces of protein. When it is found in urine, usually albumin predominates. Bence-Jones protein, haemoglobin are the significant non-albumin proteins under certain conditions. Minimal proteinuria (less than 0.5 g/day) is found following exercise or in highly concentrated urine. Fever, severe emotional or thermal stress, hypertension and lower urinary tract infection can also cause excretion of small quantities of protein.

Sugar normally is not found in urine. But when blood sugar level rise well above a target range which can occur in type 1 and type 2 diabetes, the kidneys sometimes releases sugar into the urine even when blood sugar levels are within a range.

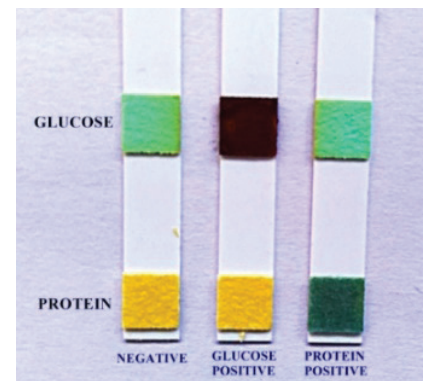

36. Total WBC count

Total white blood cell count is performed after diluting an aliquot of blood in WBC diluting fluid to lyse RBCs and stain WBCs. WBCs are counted microscopically in a haemocytometer with chambers of known volume. Since differential WBC count alone cannot reveal the true picture of infection, total WBC count is also taken into consideration.

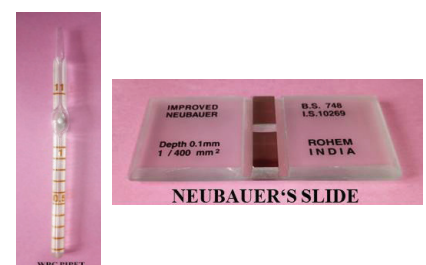

37. Differential WBC count

The white blood cell differential count determines the number of each type of white blood cell, present in the blood. It can be expressed as a percentage (relative number of each type of WBC in relationship to the total WBC) or as an absolute value is much more important than the relative value.

38. Determination of erythrocyte sedimentation rate

ESR is the rate at which erythrocytes in the anticoagulated blood sediment due to gravity when held in a vertical column. ESR is represented as fall of RBCs in mm per hour.

39. Haemoglobin estimation

Haemoglobin is a conjugated protein present in red blood cells. Haemoglobin consists of two components Haem (Iron + Protoporphyrin) and globin (amino acid chain). Haemoglobin is converted to acid haematin when treated with 0.1 N HCl. The brown colour of the resulting mixture is compared with the standard in Haemoglobinometer.

40. Isolation of chlorophylls

The chlorophylls are the essential components for photosynthesis and occur in chloroplasts as green pigments in all photoautotrophic organisms. They are bound loosely to proteins but are readily extracted in organic solvents such as acetone or ether. Chemically, each chlorophyll molecule contains a porphyrin (tetrapyrrole) nucleus with a chelated magnesium atom at the centre and a long-chain hydrocarbon (phytyl) side chain attached through a carboxylic acid group. There are at least five types of chlorophylls in plants. Chlorophylls a and b occur in higher plants, ferns and mosses. Chlorophylls c, d and e are only found in algae and certain bacteria.

41. Effect of sunlight on chlorophyll synthesis and plant growth hormone synthesis

Conversion of proplast into chloroplast requires light. If sufficient light is not available plants become yellow, the process is called etiolation. The process of chloroplast development and accumulation of chlorophyll is light dependent. This can be demonstrated by the following experiment. Under darkness plants are capable of synthesising more amount of plant growth regulators which influences the plant growth.

**42. Enzyme assay: invertase**

Our most common food sugar, the disaccharide, sucrose is formed in all green plants. The metabolism of sucrose in the animal body begins with the action of invertase (sucrase) which hydrolyses the disaccharide to two monosaccharides, fructose and glucose. This same enzyme is also produced by plants and fungi.



43. Determination of protease activity

Papain from latex of papaya and bromelain from the pineapple, are best protease enzymes from plant source. Hydrolysis of protein takes place through protease enzyme. Easily accessible source of enzyme is from fresh pineapple. Gelatin may be used as substrate for protease. Gelatin is solid below 25°C and gets liquefied at higher temperature.

44. Blood cell count – haemocytometer

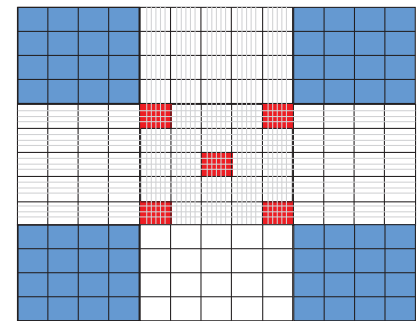
The hemocytometer (or haemocytometer or counting chamber) is a specimen slide which is used to determine the concentration of cells in a liquid sample. It is frequently used to determine the concentration of blood cells (hence the name "hemo-") but also the concentration of sperm cells in a sample. The cover glass, which is placed on the sample, does not simply float on the liquid, but is held in place at a specified height (usually 0.1mm). Additionally, a grid is etched into the glass of the hemocytometer. This grid, an arrangement of squares of different sizes, allows for an easy counting of cells. This way it is possible to determine the number of cells in a specified volume.



 Areas of the grid where WBC are counted
 Areas of the grid where RBC are counted

45. Micrometry

Micrometry refers to the measurement of microorganisms (length and breadth) seen under light microscope. Micrometry makes use of two micrometers – ocular micrometer and stage micrometer. The distance between the lines of an ocular micrometer is an arbitrary value that only has meaning if the ocular micrometer is calibrated for the objective that is being used. A stage micrometer, also known as an objective micrometer has lines scribed on it that are exactly 0.01 mm (10 μm) apart. To calibrate the ocular micrometer for a given objective, it is necessary to superimpose the two scales and determine how many of the ocular graduations coincide with one graduation on the scale of the stage micrometer.

46. Pregnancy detection

Human chorionic gonadotrophin (hCG) is the hormone produced exclusively in pregnant women after 24 hours of conceiving, the presence of low level of hormone in urine can be detected by sensitive immunochromatography technique. This test indicates the presence hCG in urine based on antigen-antibody reaction and thus detects pregnancy.

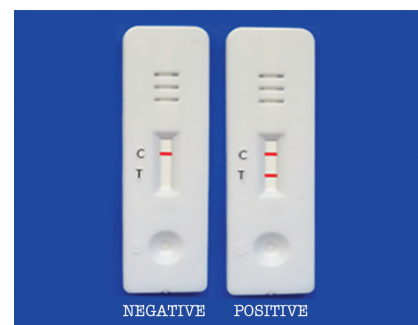

47. Study of inflorescence

An inflorescence is defined as a group or collection of flowers. In many cases, the individual flowers are inconspicuous and by themselves will not be able to attract the attention of pollinating agents. Under such circumstances they group together and form clusters called inflorescence. Based on the growth and pattern of arrangement of flower, inflorescences are categorised into various groups.

Racemose inflorescence (indefinite inflorescence):

An inflorescence in which meristematic activity continues at which apex of the main stem and primary laterals and flowers are developed from the axillary meristems. The inflorescence is often pyramidal in shape with older flower at the base or, in the case of a flat-topped arrangement, on the outside, different types of racemose inflorescence include the capitulum, corymb, panicle, raceme, spadix, spike and umbel.

Cymose inflorescence (cyme, definite inflorescence):

An inflorescence in which the epical tissues of the main stem and laterals lose their meristematic capacity and differentiate into flowers. New growth arises from continued cell division in the axillary meristems. Older flowers are usually found near the stem apex.

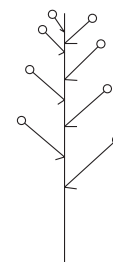

raceme

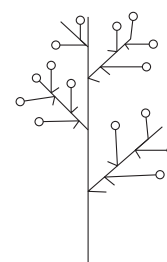

compound raceme



caesalpinia pulcherrima

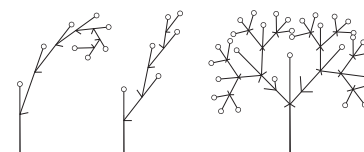

monochasial cymes

dichasial cyme

48. Pollen germination test

In flowering plants, however, the ovules are contained within a hollow organ called the pistil, and the pollen is deposited on the pistil's respective surface, the stigma. On the stigma, the germination of pollen grains begins by absorption of water and nutrients and the pollen grain produces a tiny pollen tube through the style to the ovary. The tube cell enlarges and comes out of the pollen grains through one of the germ pores to form a pollen tube. The tube nucleus descends to the tip of the pollen tube.



49. Study of placentation in plants

Placentation is organic connection between developing embryo with the mother plant. The attachment of an ovule to the ovary wall is done by placenta. If there is only one ovule in the ovary then it is usually attached either at the base (basal placentation) or the apex (apical placentation). In a simple ovary the ovules may be attached either along the ventral suture (marginal placentation) or, rarely, all over the inner surface of the ovary wall (laminar placentation). In a compound ovary the ovules may be attached either on a central axis or on the wall along the junctions of the carpels (parietal placentation). Placentation on the central axis is termed axile in a multilocular ovary and free central in a unilocular ovary. It is believed that free central and parietal placentation are derived from axile placentation. The type of placentation is an important diagnostic character in many taxa. There are different types of placentation like Marginal (ventral), Axile, parietal, free central and basal placentation.

50. *Drosophila* culturing

In order to make observation of *Drosophila*, it is important to get proper flies. These flies can be cultured on a simple medium with following ingredients: Wheat meal (rava), Jaggery, Agar agar, and propionic acid with water and boiling it. Once the medium is ready, transfer it to the culture bottles. Before introducing flies to a fresh food bottle, seed the surface of the food with a few grains of live yeast. Rearing bottles

must be kept at a temperature no higher than 80°F. and, preferably, above 70°F. They should not be exposed to direct sunlight and may be kept entirely in the dark. About 5 days after introducing flies to a fresh bottle, small larva may be seen crawling in and over the surface of the food. In about 8 days, pupa will be evident along the edges of the piece of tissue. A new generation of adults will begin to emerge from the pupa cases in about 12 days.

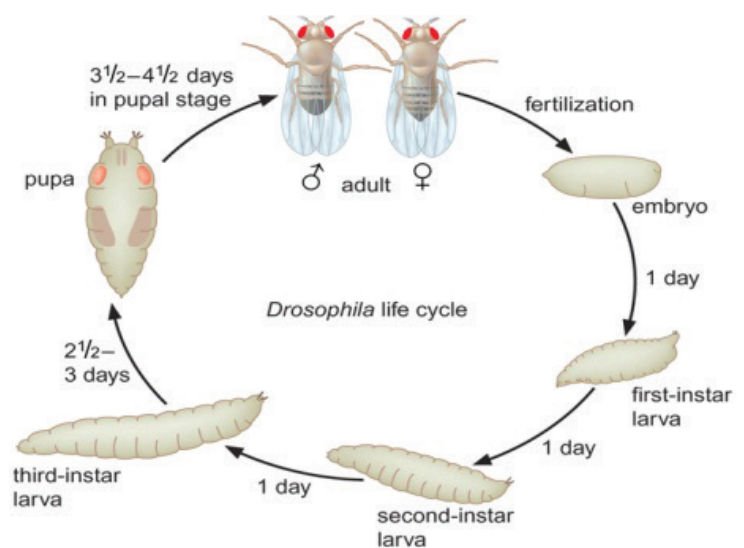

51. Study of *Drosophila* and mutants

To study *Drosophila* structures. *Drosophila* is a famous model system used to understand various aspects of life processes. A genus of small, two-winged flies accounts nearly 2500 described species. Discoveries in fruit flies have greatly contributed to our understanding in different aspects of biology. Mendel's genetic studies of the garden pea were the serendipitous consequence of his duties in the monastery garden. In contrast, *Drosophila* came to be a central organism in genetics as a result of careful consideration by Thomas Hunt Morgan at Columbia University in 1900, where he and his highly talented students A. H. Sturtevant, C. B. Bridges and H. J. Muller was looking for a suitable species in which to perform studies of heredity.

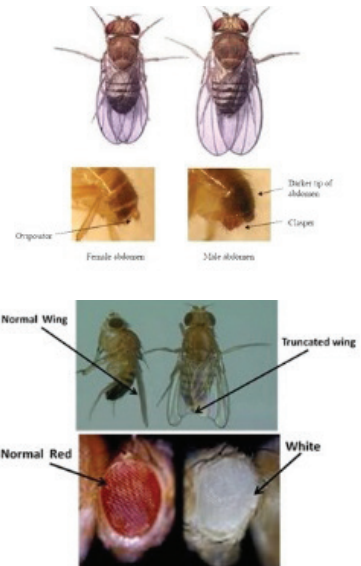

52. Blood group determination

Principle: The procedure for blood typing was developed by Carl Landsteiner (1900). The human blood types can be separated into four basic groups on the basis of two antigens that are present on the red blood cells. These antigens are designated as 'A' and 'B'. ABO typing of blood is based on the principal of agglutination, a type of reaction that occurs between particulate antigen and specific antibodies that leads to clumping of red blood cells. The presence of another antigen on RBC's of human blood, designated as Rh factor (antigen found in rhesus monkey) was reported by Landsteiner and Wiener in 1940. The presence of Rh factor is also demonstrated by agglutination reaction. The presence of Rh factor in blood is characterised as 'Positive' and the absence of which is termed as 'Negative'.



53. Isolation of DNA from plant

To isolate DNA from different plant samples by Phenol – Chloroform method. Plant cells are surrounded by cell wall. Treatment with detergent (Sodium dodecyl sulfate, SDS) is an effective way of break opening the cells and their nuclei to release the content. For this, lysis buffer containing Tris, EDTA and SDS is used. The DNA is associated with a number of proteins. These can be removed by adding phenol-chloroform and isoamyl alcohol. The phenol is removed by washing the DNA with chloroform. Finally, cold ethanol precipitates out the crude DNA. Saline sodium citrate (SSC) buffer is used to dissolve DNA.

54. The isolation of RNA from yeast

Total yeast RNA is obtained by extracting a whole cell homogenate with phenol. The concentrated solution of phenol disrupts hydrogen bonding in the macromolecules, causing denaturation of the protein. The turbid suspension centrifuged and two phases appear: the lower phenol phase contains carbohydrate and RNA. Denatured protein, which is present in the both phases, is removed by centrifugation. The RNA is then precipitated with alcohol. The product obtained is free of DNA but usually contaminated with polysaccharide. Further purification can be made by treating the preparation with amylase.

55. Isolation of bacteriophages

Bacteriophages are viruses infecting bacteria. The presence of bacteriophage in the natural environment will be relatively lower and therefore it is essential to use desired host bacteria along with the nutrients as an enrichment technique. After incubation the bacteriophages can be separated by centrifugation and then by membrane filtration. The filtration by using bacterial filters has been used to physically remove the bacteria from the liquid. The final step is to produce plaque by seeding a lawn of bacteria with the phage in the filtrate.

56. The estimation of DNA by the diphenylamine reaction

when DNA is treated with diphenylamine under acid conditions, a blue compound is formed with a sharp absorption maximum at 595nm. This reaction is given by 2-Deoxypentoses in general and is not specific for DNA. In acid solution, the straight chain form of a deoxypentose is converted to the highly reactive β -hydroxylevulinialdehyde, which reacts with diphenylamine to give a blue complex. In DNA, only the deoxyribose of the purine nucleotides reacts, so that the value obtained represents half of the total deoxyribose present.

57. Estimation of RNA by orcinol method

This is a general reaction for pentoses and depends on the formation of furfural when the pentose is heated with concentrated hydrochloric acid. Orcinol reacts with the furfural in the presence of ferric chloride as a catalyst to give a green colour. Only the purine nucleotides give any significant reaction.

58. Biofertilizers

Biofertilizers are the substances which make use of the microorganisms to fertile the soil. They are many types and each type takes care of the amount of nitrogen and phosphorus level in the soil. The microorganisms are known to interact with plants in different ways. Plant health parameters are always considered under the environmental conditions favouring the plant growth. Plant associated microorganisms particularly endophytic and rhizosphere organisms largely influence the plant growth. Use of biofertilizers is one of the important components of integrated nutrient management, as they are cost effective and renewable source of plant nutrients to supplement the chemical fertilizers for sustainable agriculture. Several microorganisms and their association with crop plants are being exploited in the production of biofertilizers. Many biofertilizers are commercially available in the market such as *Rhizobium*, *Azotobacter*, *Azospirillum*, *Azolla*, *Trichoderma*, *Pseudomonas syringae*, *Bacillus megaterium*, etc.

59. Effectiveness of hand scrubbing on microbial load

Human skin harbours various microorganisms. Some pathogenic microorganisms may also persist and transmit through contaminated hands. Various methods like washing with water and soap, swabbing with alcohol are practiced. Scrubbing the hands involves the physical removal of microbes. Depending on the condition of the skin and number of microorganisms present, it takes seven to eight minutes of washing with soap and water to remove maximum surface microorganisms and they can be killed using suitable antiseptics such as 70% alcohol or Dettol.

60. Seed health testing

Fungi are major pathogens of plants. They are transmitted through seed both externally and internally. In this method, when moisture is provided to seed they imbibe water. The fungi present in and on it get expressed as seed itself acts as nutrient source. This method is called detection of seed born fungi by blotter method.

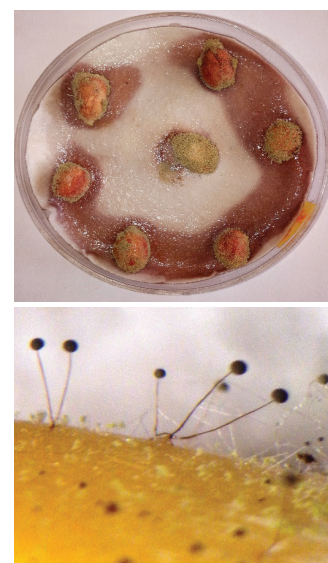

61. Determination of susceptibility to dental caries

Dental caries commonly known as tooth decay. A variety of microorganisms are known to be involved in formation of dental caries. This test measures the amount of acid produced by the bacteria. The test employs a differential medium, Snyder agar (pH 4.7), which contains glucose as carbon source and bromocresol green as pH indicator which gives green colour to the medium. Upon acid production by microbes, the pH of the medium tends to lower from 4.7 to 3.8 and below. At this pH the green colour of the medium changes to yellow. The sample demonstrating yellow colour within 24–48 hours is suggestive of the host susceptibility to formation of dental caries.

62. Antibiotic sensitivity test

Antibacterial agents are chemicals that can kill or inhibit the growth of bacteria termed as bactericidal or bacteriostatic compounds respectively. When the discs impregnated with antibacterial agents come in close contact with the medium, they get diffused into the medium thus inhibiting the growth of bacteria. The diffusion takes place in circular fashion hence the zone of inhibition appears around the disc. The effectiveness of an antibiotic in this method is based on size of zone of inhibition. The zone of inhibition varies with diffusibility and concentration of the antimicrobial compound, size of inoculum, type of medium used and many other factors. The method was originally standardised by W.M.M. Kirby and A.W. Bauer in the year 1969, so the method is also known as Kirby-Bauer method.

**63. Alcohol fermentation by yeast**

The yeast *Saccharomyces cerevisiae* converts the fermentable sugars (Glucose, fructose and sucrose) into ethanol and CO_2 . In the large-scale production of alcohol, molasses is used as the substrate for yeast fermentation molasses, a byproduct in the sugar refinery industries, contains about 45-55% w/v of fermentable sugar as sucrose. Sucrose is metabolised by yeast through Embden-Meyerhof pathway (EMP) and alcohol and CO_2 are the products of the fermentation.

64. VDRL test (RPR)

This Diagnostic reagent kit is used for detection of antibodies produced in mankind in response to the stimulation by disease known as syphilis caused by *Treponema pallidum*. RPR test is a modified version of Wassermann's reaction in which the antigens coated with carbon particle are allowed to react

with the sample and if the antibodies for syphilis are present the flocculation will occur on the slide due to aggregation of carbon particle, if the sample does not contain the antibody then carbon particle will aggregate in the centre of slide to give an appearance of button which indicates negative reaction.

65. WIDAL test

Typhoid fever is an acute infectious disease characterised by definite lesions in Peyer's patches, mesenteric glands and spleen accompanied by fever, headache and abdominal symptoms. It is also called 'enteric' fever. Most frequent and dangerous complication in the late stages of this fever is intestinal haemorrhage and perforation. The causative organism of the typhoid fever is a gram-negative bacillus, *Salmonella*. In our country typhoid is commonly caused by *Salmonella typhi*, *S. paratyphi A* and *S. paratyphi B*. These organisms possess somatic (O) as well as flagellar 'H' antigens. The three serotypes have common 'O' antigen but possess different 'H' antigens. During infection with these bacteria, antibodies appear in the patient's, within 2 to 5 weeks. A rising titre is highly significant for diagnosis of an infection. The detection of these antibodies in suspected patients forms the basis of the 'Widal' test.

66. Milk test

To determine the quality of milk. There are different methods for milk testing that can easily be performed in the farm like Organoleptic tests, clot on boiling test, alcohol test and turbidity test.

67. Study of plant diseases

To study different diseases of plants. Agrios (1997) has defined plant disease as a series of invisible and visible responses of plant cells and tissue to a pathogenic microorganisms or environmental factors that result in adverse changes in the form, function or integrity of the plant and may lead to partial impairment or death of the plant or its parts. Plant diseases are caused by fungi, bacteria, mollicutes, protozoa, nematodes, viruses, viroids and angiospermic plant parasites. A plant disease is diagnosed with the help of signs and symptoms appearing on them due to infection. The symptoms may or may not be characteristic as more than one organism can cause same symptoms. To diagnose a plant disease, one need to know the normal conditions of plants and symptoms of different plant diseases.

68. Agarose gel electrophoresis

Electrophoresis is a technique used to separate charged molecules. DNA is negatively charged at neutral pH. When electric field is applied across the gel, DNA migrates towards the anode. Migration of DNA through the gel is dependent upon Molecular size of DNA. Matrix of agarose gel acts as a molecular sieve through which DNA fragments move on application of electric current. Higher concentration of agarose gives firmer gels and hence smaller DNA fragments crawl through these spaces. As the length of the DNA increases, it becomes harder for the DNA to pass through the spaces, while lower concentrations of agarose help in movement of larger DNA fragments as the spaces between the cross-linked molecules is more. The progress of gel electrophoresis is monitored by observing the migration of visible dye through the gel referred as 'tracking dye'. Since DNA is not naturally coloured, it will not be visible in the gel. An intercalating dye Ethidium bromide is added in agarose gel during preparation. After electrophoresis, the gel is removed from the tank and placed on a UV-transilluminator to observe fluorescing DNA bands.

69. Restriction digestion of DNA

Restriction enzymes are enzymes isolated from bacteria that recognise specific sequences in DNA and cleave double-stranded DNA (dsDNA) at specific sites to produce fragments, called restriction fragments. Restriction enzymes are Nucleases which can cleave the sugar-phosphate backbone of DNA. As they cut within the molecule, they are commonly called 'endonucleases'. Restriction enzymes are found naturally in bacteria. Each restriction enzyme has specific requirements to achieve optimal activity. Conditions such as temperature, pH, enzyme cofactor(s), salt composition and ionic strength affect enzyme activity and stability. Restriction endonucleases recognise palindromic sequences. In other words, palindromic sequences are complimentary strands that read the same in opposite direction.

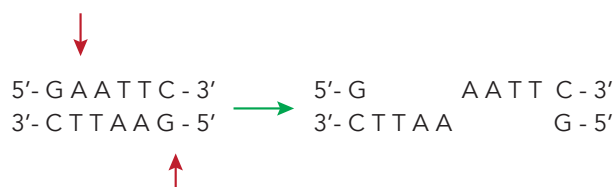

70. Ligation of DNA fragments

Construction of DNA molecule is dependent on the ability to covalently seal single stranded nicks in DNA. This process is accomplished both in vivo and in vitro by the enzyme DNA ligase. It catalyses the formation of phosphodiester bonds between juxtaposed 5' phosphate and 3' hydroxyl terminus of double stranded DNA and join double stranded DNA restriction fragments having either blunt ends or homologous cohesive ends. *E. coli* ligase and T4 DNA are the two DNA ligases used in nucleic acid research. They differ in their requirement for energy source and in their ability to ligate blunt ends. T4 DNA ligase is approximately 60 kD protein produced by bacteriophage T4 requiring ATP as energy source. T4 DNA ligase has the unique ability to join sticky and blunt ended fragments.

71. SDS page for proteins

Gel electrophoresis is a technique used for the separation of nucleic acids and proteins. Separation of large (macro) molecules depends upon 2 forces: charge and mass. When a biological sample, such as proteins or DNA is mixed in a buffer solution and applied to a gel, these 2 forces act together. The electrical current from one electrode repels the molecules, while the other electrode simultaneously attracts the molecules. The frictional force of the gel material acts as a "molecular sieve," separating the molecules by size. During electrophoresis, macromolecules are forced to move through the pores when the electrical current is applied. Their rate of migration through the electric field depends on the strength of the field, size and shape of the molecules, relative hydrophobicity of the samples and on the ionic strength and temperature of the buffer in which the molecules are moving. After staining, the separated macromolecules in each lane can be seen in a series of bands spread from one end of the gel to the other. The polyacrylamide gel electrophoresis (PAGE) technique was introduced by Raymond and Weintraub (1959).

72. Microscopic examination of pond water

Pond is an important aquatic ecosystem consisting of various microorganisms such as bacteria, fungi, algae and protozoa. Microscopic examination of a drop of pond water through wet mount preparation provides considerable amount of information on diversity of microorganisms based on their shape, colour and motility.

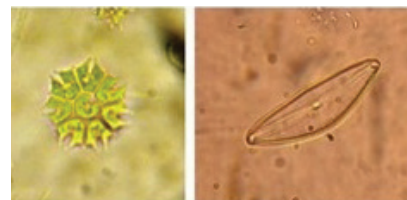

73. Cell immobilisation

Immobilisation is a technique in which the cells are retained in a restricted space or surface of certain matrices but retain their catalytic activity. The methods available for immobilisation are classified into two broad types. Attachment on the insoluble support and entrapment in matrix. Because of the large size of the cells, entrapment is a widely used technique. Whole cells can be immobilised by entrapping them in spheres of alginate gel. This technique is commonly used in industry, and does not impair cell activity. There are several advantages in using immobilised cells; cells can be used for long periods of time, and the product is obtained uncontaminated with enzymes.

74. Ammonification in soil

The nitrogen in most plants and animals exists in the form of protein. When animals and plant die, the protein is broken down to amino acids, which in turn are deaminated to liberate ammonia. The process of production of ammonia from organic compounds is called ammonification. Ammonification is one of the important steps in the nitrogen cycle. The majority of bacteria in soil are able to take part in this process. In this experiment, peptone broth inoculated with a sample of soil, incubated for few days and tested for ammonia formation. The presence of ammonia is detected by the formation of brown coloured precipitate after addition of Nessler's reagent.

75. Determination of biological oxygen demand (BOD) of water

BOD is the index of water pollution. In the presence of organic and inorganic waste products numerous microorganisms grow. These act as food base for the microorganisms, hence they decompose and utilise the substrates. However, the amount oxygen required by bacteria during aerobic decomposition of organic compounds in sewage is called BOD. It is also represented by the amount of organic matter present in water or effluents. For more oxygen is required by bacteria for its decomposition. This results in release of organic nutrients in water bodies such as lakes, river, ponds, etc. resulting in death of fish (asphyxiation). For measuring BOD, water samples are incubated at 20°C for 5 days in dark under aerobic condition, whereas the same can be incubated at 27°C for 3 days in tropical and subtropical regions where metabolic activities are higher. Oxygen also consumed during nitrification, therefore, 1ml of 0.05% alkylthiourea should be added to water sample to check over estimation of BOD.

76. Chemical oxygen demand (COD) of water

COD refers to the oxygen consumed by the oxidisable organic substances. The chemical oxidants such as potassium dichromate ($K_2Cr_2O_7$) or potassium permanganate ($KMnO_4$) are used to measure the oxidisability of the organic matter of water, where the oxidants oxidise the constituents (or the hydrogen but not nitrogen). Then potassium iodide (KI) is added. The excess amount of oxygen reacts with KI and liberates iodine. The excess amount of oxygen liberates equal amount of iodine. By using starch indicator, iodine is treated with sodium thiosulfate and amount estimated.

77. Determination of dissolved oxygen of water

Some amount of oxygen is dissolved in water is used by the aquatic plants and animals. The sources of Dissolved oxygen, and air are the autotrophic aquatic plants which as a result of photosynthesis evolve oxygen, and air where from oxygen is dissolved in water depending on salinity, Temperature and water movement. Moreover, in an oligotrophic lake the amount of dissolved nutrient salts remains low, therefore it supports sparse plant and animal lives. This results in high dissolved oxygen gradually increasing with depth. In addition, in eutrophic water reservoirs e.g. lakes, ponds, pools etc. The organic nutrients accumulate abundantly which is turn are subjected to microbial decomposition. More growth of microorganisms, plants and animals depletes oxygen. This depletion increases with increase in water depth. Dissolved oxygen is measured by titrimetric method. The theory behind this method is that the dissolved oxygen combines with manganese hydroxide which in turn liberates iodine (equivalent to that of oxygen fixed) after acidification with H_2SO_4 . The iodine can be titrated with sodium thiosulfate solution by using starch indicator.

78. Detection of chlorine in water

The portable water is chlorinated to make the water free from microorganisms. However, some times the concentration of chloride ions in water is increased than what is normally required. Apart from this water also receives chloride ions from multifarious sources. The chloride ions (Cl) can be estimated by titrating with silver nitrate solution.

79. Determination of total alkalinity of water

Generally, pH of water remains neutral. Alkalinity of water represents the presence of hydroxyl ions (OH⁻) in water, hence, it is capacity of water to neutralise a strong acid. In neutral or waste water alkalinity is due to the presence of free hydroxyl ions which cause through hydrolysis of salts by weak acids and strong bases (e.g. carbonate and bicarbonates).

80. Bacteriological examination of water: MPN test

This test is used to quantify the number of bacteria in water. The most probable number (MPN) is an indirect count technique relying on statistical interpretation on growth (gas) or no growth (no gas) observation in the inoculated tubes. The test conducted in three steps such as presumptive test, confirmatory test and complete.

APPENDIX C: BSc Experiments

First two semester BSc subjects are repeat of PUC and elaborate coverage of PU subjects. In addition, BSc teachers have not done most of the PU experiments described here in appendix B. Therefore some of the experiments described for PU have to necessarily repeat. However, emphasis for BSc is to make the teachers learn the subject more rigorously since they have more number of days. The experiments are well conceived to learn theory in all the three subjects. Experiments cover over 85% of subject they teach in theory classes. Most of the experiments are designed in TDC. Many subjects are common for Physics and Chemistry and so the experiments repeat.

BSc PHYSICS EXPERIMENTS

Electronics

1. Understanding of Cathode Ray Oscilloscope and Digital Multimeter

In this experiment, we measure peak and rms voltage and the frequency of AC using a CRO. To measure resistance, ac and dc voltage, ac and dc current using digital multimeter.

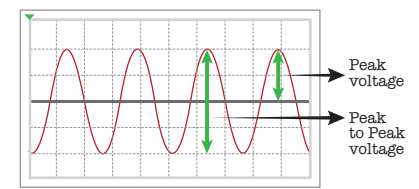

2. Diode Characteristics/ LED/Zener diode

In this experiment, we draw the forward and reverse bias characteristics curve of a semiconductor diode. And determine knee voltage and bulk resistance.

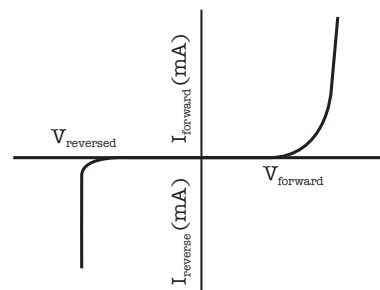

3. To study full and half wave rectifier circuits

Draw the waveform of a half wave and full wave rectifier circuit and compare the Output VDC by using the multimeter. We observe a half wave and full wave rectifier output through CRO.

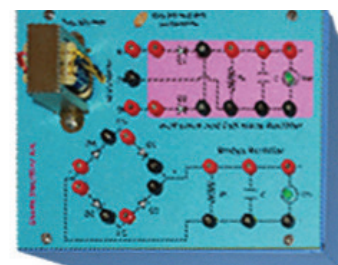
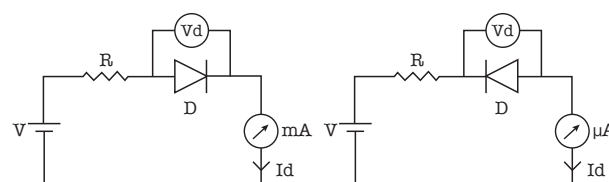

4. Transistor characteristics

In this experiment, we study the input and output characteristic of a given transistor and determine its α and β .



5. Characteristics of Field Effect Transistor

In this experiment, we study and plot the transfer and drain characteristics of given FET and determine R_d , g_m , μ , I_{DSS} and V_p .

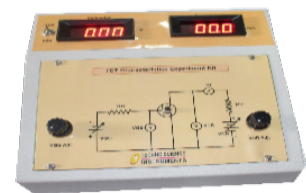

6. Transistor (Common Emitter) Amplifier Circuit

In this experiment, we study the Amplifier characteristics of a given transistor. Determine various DC voltages and plot the Q point. And connect a sinewave input and observe the amplified output on oscilloscope.



7. Operational Amplifier circuits using IC 741

In this experiment, we study different types of Operational amplifier.

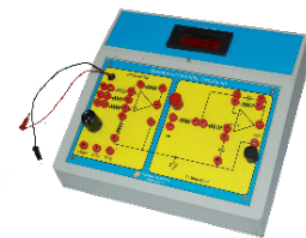

8. Wein Bridge Oscillator using IC-741 OPAMP

In this experiment, we design, construct and test the Wein Bridge Oscillator using 741 Op-Amp.

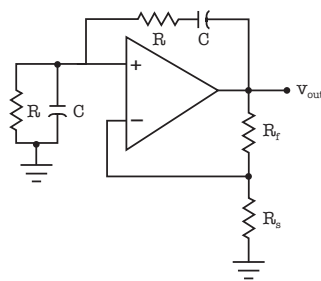

9. Verification of DeMorgan's Theorems

In this experiment, we verify DeMorgan's theorem.

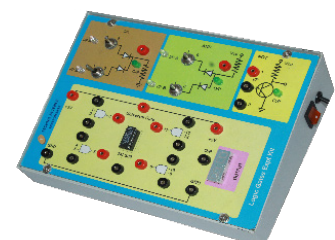
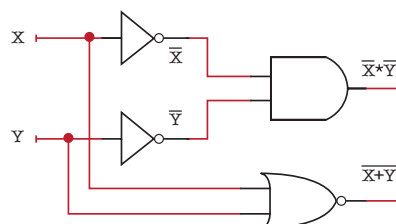

10. Analog to Digital converter ADC

In this experiment, we convert an analog signal to a digital signal.



11. Digital to Analog Converter (DAC)

In this experiment, we Construct a staircase generator using 8-bit DAC IC DAC0800 and observe its output on Oscilloscope.



12. 4-bit BCD counter with 7 segment Display decoders

In this experiment, we design a 4-bit BCD counter with 7 segment Display decoders.



13. Astable Multivibrator

A Multivibrator is two-state electronic devices such as relaxation oscillators, timers and flip-flops. It has two amplifying devices (transistors vacuum tubes or other devices) cross coupled by resistors or capacitors.

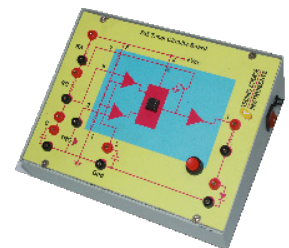

14. Amplitude modulation

In this experiment, we observe the amplitude modulation and demodulation wave pattern. Information can be sent from a transmitter to a receiver by means of modulation and demodulation, respectively, whether those signals are light waves moving through optical cables, radio waves through metallic cables, or radio waves propagating through the air.

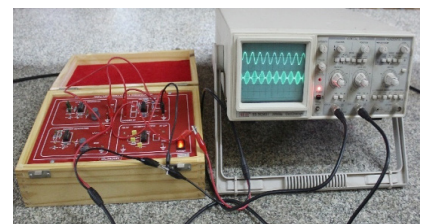

15. Voltage Regulator Power Supply

In this experiment, we construct the variable and constant Voltage Regulator power supply Using 3 Terminal Regulator IC.

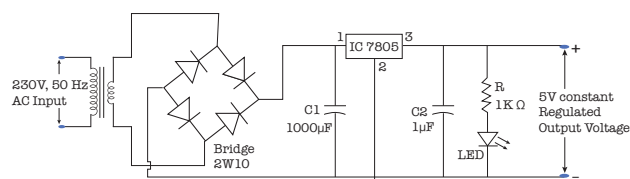

16. Thevenin's Theorem

We verify the Thevenin's theorem and find the full load current for given circuit. Thevenin's theorem states that any two terminals of a linear network containing linear impedances and energy sources can be replaced with an equivalent circuit consisting of a voltage source in series with an impedance, where the open circuit voltage between two terminals of network and the impedance measured between terminals with all the other energy sources being replaced by their internal impedances.



17. Norton's Theorem

In this experiment, we verify the Norton's theorem. Norton's theorem states any two terminals of a network containing energy source and impedances can be replaced by an equivalent circuit consisting of current source in parallel with a resistance, where the short circuit current between the two terminals of the network and the resistance measured between the terminals with all energy sources replaced by their internal resistance.

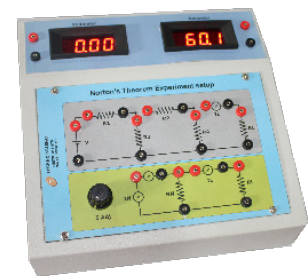

18. Maximum Power Transfer Theorem

It states that, in a linear, bilateral circuit the maximum power will be transferred to the load when load resistance is equal to source resistance. In this experiment, we verify the Maximum Power transfer theorem.

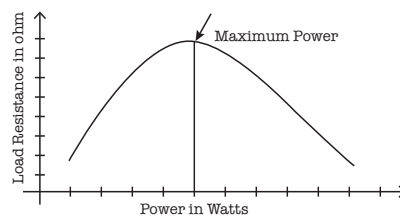

Heat and Thermodynamics

19. Measurement of atmosphere pressure by Hg barometer

Atmospheric pressure is defined as the force per unit area exerted against a surface by the weight of the air above that surface of a planet. It varies with latitude. The average sea-level earth's atmospheric pressure is 1013.25 mbar = 101.325 kPa = 760 mmHg.

$$P = \rho gh \text{ Pa,}$$

$$h = 0.76\text{m}; \rho = 13.6 \text{ g/cc}; g = 9.81 \text{ m/s}^2;$$

$$P = 101.367 \text{ kPa}$$

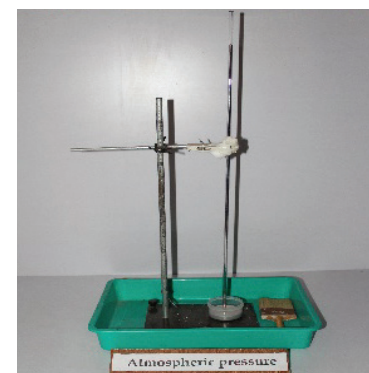

20. Boyle's law

We verify Boyle's law by changing pressure and volume at constant temperature. i.e., PV is constant at constant temperature. Here we use water column to find the pressure instead of mercury column.

**21. Gas Law (Gay-Lussac law) / Charles' Law**

In this experiment, we verify the Charles' law and Gay-Lussac law by changing the pressure and temperature at constant volume by using water column and monometer. And plotting graph P vs T to find absolute temperature.

**22. Determination of Absolute Zero**

In this experiment, we study the relationship between pressure and temperature of given gas under constant volume and to find absolute zero. This is another verification of Charles' law. Plot P vs T , it gives absolute zero.

**23. Specific heat of metal**

We determine specific heat of solids by the method of mixtures. Here the calorie meter is a simple glass beaker and its gives good results as compared to classical way of doing.

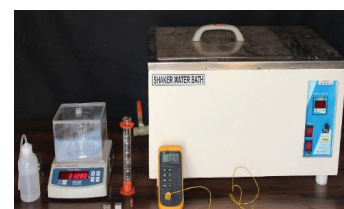
**24. Specific heat of liquid**

In this experiment, we measure the specific heat capacity of water.

**25. Latent heat of fusion of ice**

In this experiment, we determine the latent heat of the ice when the ice undergoes its phase change from solid to liquid. A glass beaker is used as a calorie meter.



26. Linear thermal expansion coefficient

We determine linear coefficient of thermal expansion of wire by applying current to wire to expand. By applying Pythagoras one can find linear coefficient of thermal expansion of a metal. This Apparatus measure 1mm in 1000 mm.

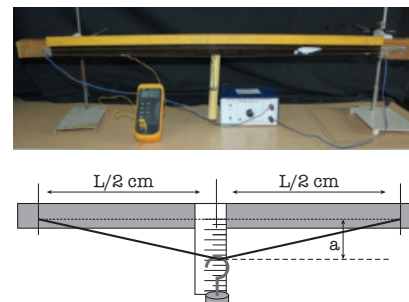

27. Newton's law of cooling

In this experiment, room temperature is noted. The calorimeter is filled with hot water. The temperature is noted and the timer is started. The variation in temperature is noted as function of time. The observations are tabulated and a graph is plotted with $\log_e(\theta_{body} - \theta_{sur})$ on the Y axis and time on the X axis. A straight line is obtained.



28. Determination of latent heat of vaporisation using Clausius – Clapeyron equation

The specific entropy 's' for a homogeneous substance is a function of specific volume 'v' and temperature

$$Tds = \left(\frac{\partial s}{\partial v}\right)_T dv + \left(\frac{\partial s}{\partial T}\right)_v dT$$

The Clausius-Clapeyron relation characterises behaviour of a closed system during a phase change, during which temperature and pressure are constant.

29. Enthalpy of neutralisation

In this experiment, we determine the enthalpy of neutralisation of HCl with NaOH by calorimetric method by assuming the specific heat of NaCl solution is the same as that of water, beaker and thermometers absorb negligible amount of heat, and the total volume of water is the same as the total volume of the solutions.

30. Enthalpy, Entropy and Gibb's free energy

Determination of ΔH^0 and ΔS^0 of CaO-H₂O system. $\Delta G_T^0 = \Delta H^0 - T\Delta S^0$. At any temperature ΔH^0 remains constant. Solve for ΔH^0 and ΔS^0 using two of equations obtained at two different temperatures.

31. Variation of vapour pressure of water with temperature

In this experiment, water vapor must be in equilibrium with liquid water at any given temperature from 0°C to 100°C. Thus, the glass bulb is immersed in water and heated. The vapor pressure is measured using pressure gauge. Plot P_{H₂O} vs temperature.



32. Determination of universal gas constant R

In this experiment, we determine Universal gas constant R using the equation, $PV = nRT$.

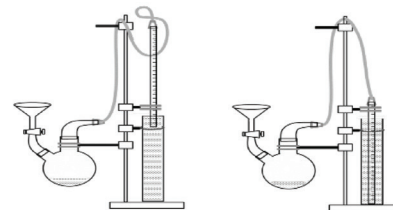

33. Solar constant

In this experiment, we Measure Solar constant and hence the luminosity of the Sun. The solar constant (**S**) is the amount of energy incident normally per unit area per unit time on the surface of earth. This can be determined by exposing a metal plate normal to solar radiation and measuring its raise in temperature. Once **S** is obtained the Luminosity of Sun can be estimated.



34. Determination of C_p/C_v for different gases using Resonance Column*

In this experiment, velocity of sound V_s at room temperature can be determined using resonance column by,

$$V_s = 2f(l_2 - l_1)$$

The velocity of sound in any gas is given by

$$V_s = \sqrt{\gamma RT/M}$$

By measuring the V_s in different gases in the resonance phenomenon, C_p/C_v of the gas can be determined.

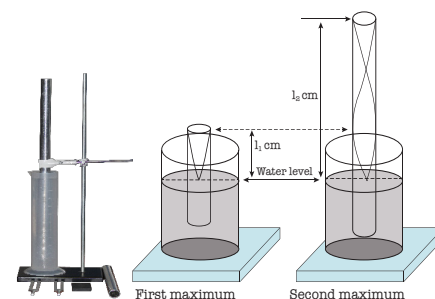

Light and Ray Optics

35. Determination of wavelength of light – Diffraction through grating

where m = order number, d = distance between the two adjacent grating slits, θ_m = angle between m^{th} order fringe and the 0^{th} order fringe to the grating.



36. Wavelength of light in water, refractive index of water, velocity of light in water

In this experiment, we determine distance between grating lines, wavelength, refractive index of liquid and speed of light in liquid.

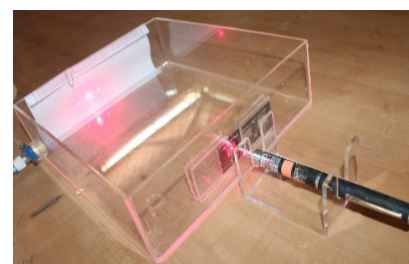

37. Refractive Index of Glass Prism for different colours – through prism Spectrometer

In this experiment, we determine angle of the glass prism, angle of minimum deviation of different colours and refractive index of given glass prism.

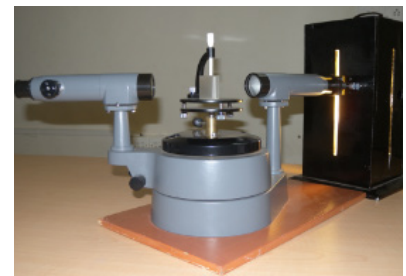
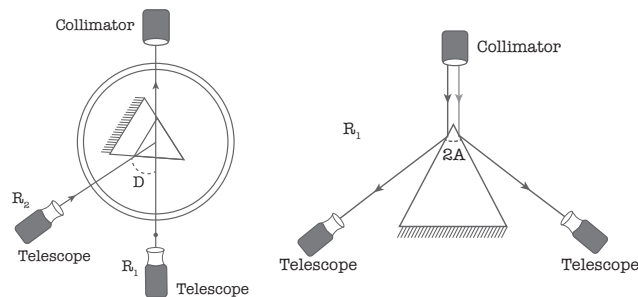

38. Newton's Rings

In this experiment, we determine the radius of curvature of a given convex lens using Newton's rings experiment. The travelling microscope is moved slowly to the one side to cover, say, twenty-one dark rings. The rings are counted as $n, n+3, n+6$ up to $n+21$. The vertical cross wire is made tangent to $(n+21)^{th}$ dark ring and the reading in horizontal scale is noted.

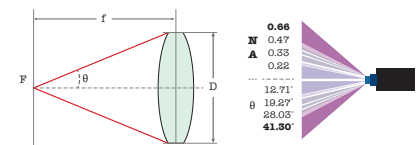

39. Air wedge

In this experiment, we measure the thickness of an object from the interference pattern produced by an air wedge.

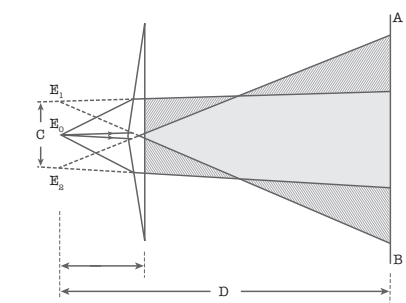

40. Fresnel's Biprism

In this experiment, we determine the wavelength of the sodium light from the interference pattern produced by a Fresnel biprism.

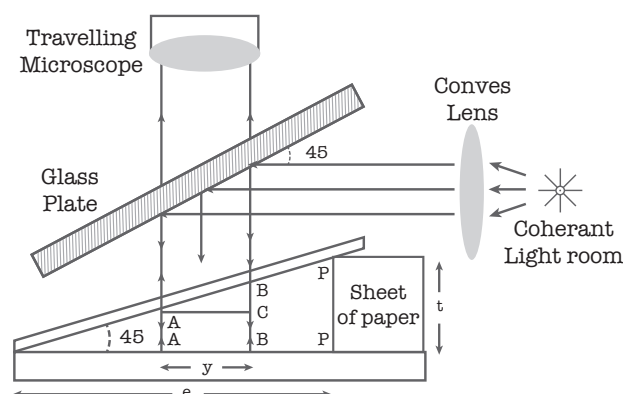

41. Numerical aperture of an Optical Fibre Cable

In this experiment, we find the numerical aperture of the fiber optics cables.

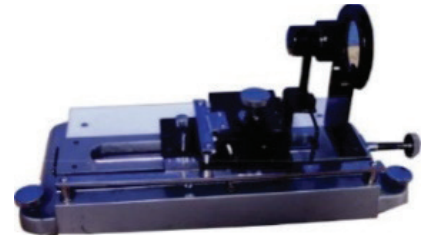

42. Attenuation in OFC

As light travels along a fiber, there is attenuation which results in the loss of optical power. It is mainly due to absorption of the signal by the fiber material, scattering by the walls of the fiber, and bending of light resulting from laying of the cable. Each of these contributes to the total amount of fiber attenuation.



43. Bandwidth Determination of OFC

In this experiment we determine band width of optical fiber cable.



44. Solar Cell

Solar Cell I-V Characteristics Curves are basically a graphical representation of the relationship between the current and voltage of the solar cell. I-V curves provide the information required to configure a solar system so that it can operate as close to its optimal peak power point (MPP) as possible.

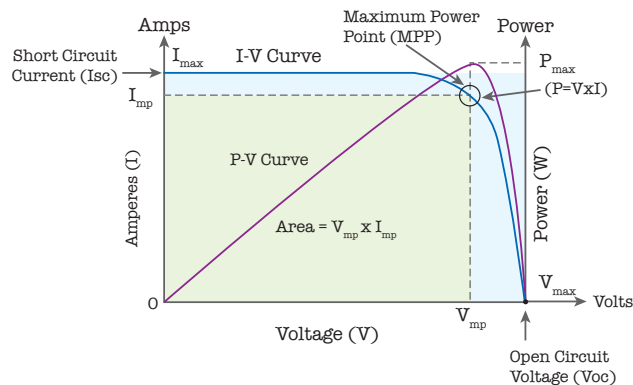

45. Determination of Specific rotation

In this experiment, we determine the specific rotation of given sugar solution.

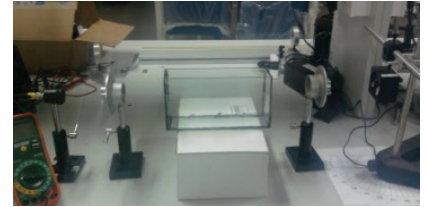

46. Determination of grating constant

In this experiment, we determine the grating constant of the given grating using formula $\sin(\theta) = Nm\lambda$



47. Brewster's angle

When light is incident on a transparent solid material, part of it gets reflected and another part gets refracted. If light strikes the interface such that there is 90° angle between the reflected and refracted rays, the reflected light will be linearly polarised. The angle of incidence that produces an angle of 90° between the reflected and refracted rays is called the Brewster's angle, θ_B .



48. Diffraction due to Helical Structure

In this experiment, we determine geometrical parameters of helical structures using diffraction.

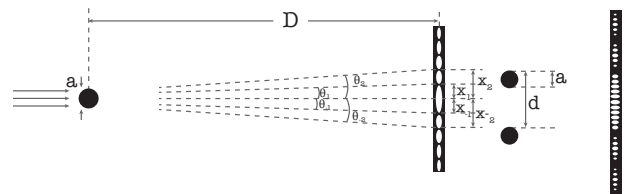

Atomic Physics

49. Energy of a photon and electromagnetic spectrum

We observe the dispersion of light to determine the wavelength of different colours of light using digital spectrometer and calculate the energy of a photon associated with them. This is an excellent experiment to determine the energy of a photon.

$$E = hv = hc/\lambda$$



50. Determination of Planck's constant – Photoelectric effect

We determine the Planck's constant using different filters. By plotting a graph frequency vs stopping potential, we can find Planck's constant and work function of photosensitive metal.

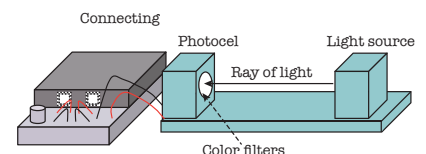

51. Millikan's Oil Drop Experiment

In this experiment, the charge and radius of oil drops will be determined using the Millikan's apparatus. In this celebrated experiment, an electric field applied across the plates of the capacitor will balance the weight of a charged oil drop along with the viscous and buoyant force.

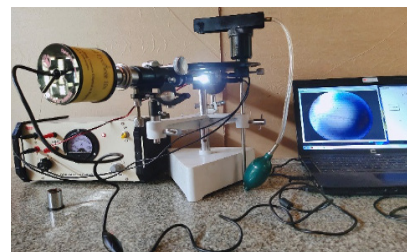

52. Black Body Radiation

In this experiment, we find experimentally that the intensity of radiation increases with wavelength and reaches maximum at a particular wavelength and then decreases exponentially.

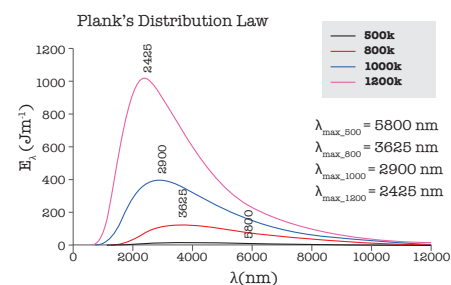

53. Stefan Boltzmann Law

In this experiment, we determine the Stefan-Boltzmann Constant

$$\frac{E}{A} \propto T^4$$



54. Arc Spectra

When a large current is passed through two closely held metal electrodes, it produces arc light which can be analysed using a spectrometer. However, it is somewhat cumbersome to analyse this spectrum by a spectrometer.



55. Determination of Avogadro number

In this experiment, electrodeposition of copper is used to determine Avogadro number. A known quantity of electricity is passed through copper sulphate solution using copper plate as anode and stainless steel as cathode. The mass of copper deposited is proportional to the quantity of electricity passed.



56. Determination of e/m of electron

In this experiment, we determine the ratio of electronic charge 'e' to the mass 'm' of electron by Thomson's method using formula

$$\frac{e}{m} = \frac{1}{KB_H^2} \left(\frac{V_y}{(\tan \theta)^2} \right)$$

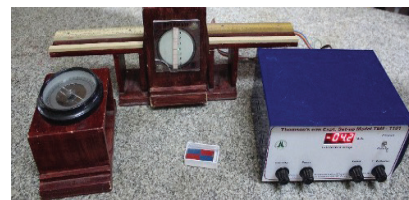

57. Temperature coefficient of resistance, α, of metal

Resistance of metals increases with increasing temperature. In this experiment, we find the variation in resistance of Cu wire with temperature.



58. Temperature Dependence of Resistance of Semiconductor Determination of Energy Band gap, E_g

Semiconductors are the basic blocks of today's electronics. Unlike metals, the electrical resistivity of a semiconductor material decreases with increasing temperature. In this experiment, we examine the temperature variation of resistance of a semiconductor.

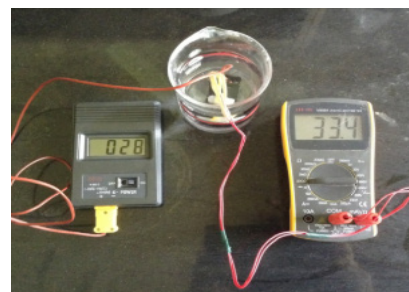

59. Compton Scattering

In this experiment, we determine the transmission coefficient of aluminium and Compton wavelength of electron.



60. Bragg's Law and Absorption of X-rays

In this experiment, we determine the inter-planar spacing in the case of KBr crystal. And determine the attenuation of the X-radiation and mass absorption coefficient μ/ρ for aluminium as a function of wavelength.



61. Hydrogen emission spectra

In this experiment, we measure the wavelength of the Balmer line from the hydrogen lamp and find the energy of red light of hydrogen emission spectrum = 1.89 eV, Verifying Bohr's theory of light emission from H atom.



62. Hydrogen Spectra and determination of Rydberg Constant

In this experiment, we determine the Rydberg constant R and energy level diagram of hydrogen using

$$\frac{1}{\lambda} = R \left[\frac{1}{2^2} - \frac{1}{n^2} \right]$$



Nuclear Physics

63. Simulation of half-life of radioactive decay using rolling of dice

The half-life of an element undergoing radioactive decay is the time for the amount to become half of its initial value. Thus, half-life of a radioactive element is given by

$$T_{1/2} = \frac{0.693}{\lambda}$$

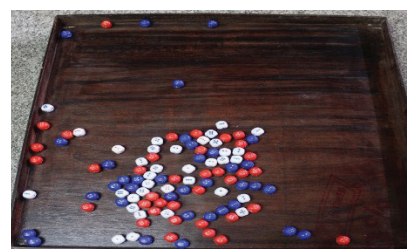

64. Long Half-life of K^{40} for β -decay

G M counter is usually filled with a noble gas like He, Ne, Ar etc. In this counter the discharge can be quenched by the following methods.

- (i) Externally by suitable electronic circuit
- (ii) More simply in an external way by adding a poly atomic gas like ethyl alcohol vapour to the argon gas.

65. Dead time of a Geiger Muller tube

The dead time of a Geiger tube is the period between the initial pulse and the time at which a second discharge, regardless of its size can be developed. In most Geiger counter, this time is about 50–100 μs .

66. Absorption and end point energy of β - ray

In this experiment, we study the absorption of β - ray and to find the β - ray end point energy for the given sources Sr, Tl and Pb using feather's formula.

67. Absorption of γ - ray emission

In this experiment, we study the absorption of γ - ray emitted from the given source and determine the absorption coefficient in lead.

68. Gamma ray spectra of different sources and hence to calibrate the scintillation γ – ray spectrometer

In this experiment, we plot the γ – ray spectra of different sources and hence to calibrate the scintillation γ – ray spectrometer. Determine the energy of unknown γ - source and hence to identify the source.

Electricity and Magnetism

69. Parallel plate capacitor and combination of capacitors

In this experiment, we construct parallel plate capacitors and find the separation distance of the parallel plate capacitor. And verify law of effective capacitance when connected in series and parallel.



70. Drawing the Electric Field Lines of Force

In this experiment, we study the electric field lines of forces of different combinations of charges and determine the electric equipotential surfaces.

71. Electric potential difference inside a conductor

It is known that the electric potential within a conductor is constant, which means that there is no electric field inside the conductor. Net charge can only reside on the surface of a conductor. And verify these properties, we will find the electric potential difference inside a conductor.

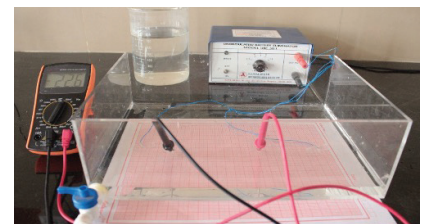

72. Charging and discharging of capacitor

In this experiment, we find out the charge-discharge characteristics of an electrolytic capacitor, determine time constant, charge stored and voltage across the capacitor. And plotting the charging and discharging curve.

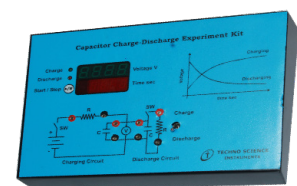

73. Current and Voltage phase difference in RC circuit

In this experiment, we find the phase difference between current and voltage in RC circuit using CRO

$$\phi = \tan^{-1} \frac{X_C}{R} = \tan^{-1} \left(\frac{1}{\omega CR} \right) = \tan^{-1} \left(\frac{1}{2\pi\nu CR} \right)$$

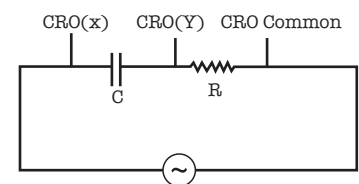

74. Current-Voltage phase difference in RL circuit

In this experiment, we find the phase difference between current and voltage in RL circuit using CRO.

$$\phi = \tan^{-1} \frac{X_L}{R} = \tan^{-1} \left(\frac{\omega L}{R} \right) = \tan^{-1} \left(\frac{2\pi\nu L}{R} \right)$$

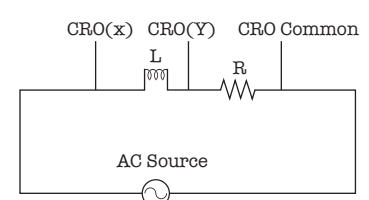

75. Parallel resonance of an RLC circuit

In this experiment, we find out the resonant frequency of a parallel RLC circuit and check with its theoretical value, and Plotting the series current vs frequency curve.

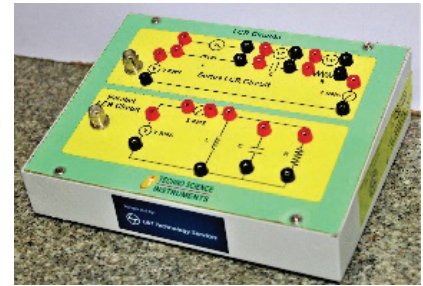
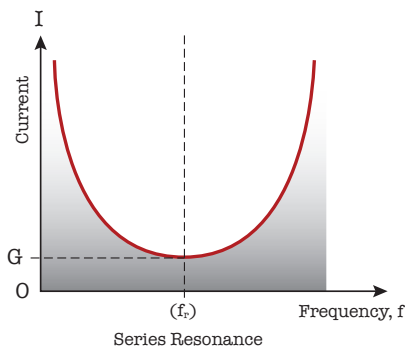

76. Series resonance of an RLC circuit

In this experiment, we find out the resonant frequency of a series RLC circuit and check with its theoretical value. And Plotting the series current vs frequency curve.

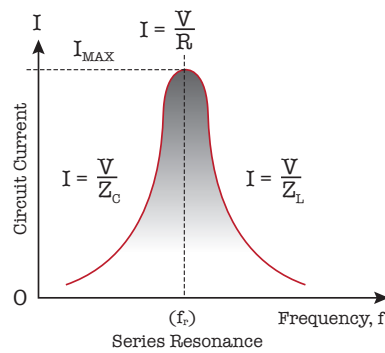

77. I-V Characteristics of a Photodiode

In this experiment, we find the responsivity and quantum efficiency of a photodiode.

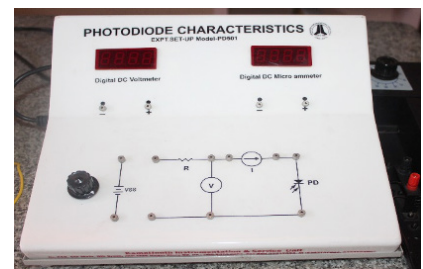

78. Diamagnetic susceptibility

Magnetic susceptibility represents the magnetising power of a material. In SI units both M and H are expressed in Ampere/meter (A/m). Hence, volume susceptibility is dimensionless. We have used a gaussmeter to measure magnetic field and as the digital balance gives weight in grams. The result obtained is in CGS system. The final result is converted to SI units by multiplying the value in CGS units by 4π .



79. Paramagnetic susceptibility

In this experiment, we determine the paramagnetic susceptibility of Nickel ammonium sulphate using formula $M = \chi H$.



80. Quincke's Method

In this experiment, we determine the magnetic susceptibility of manganese sulphate by Quincke's Method.

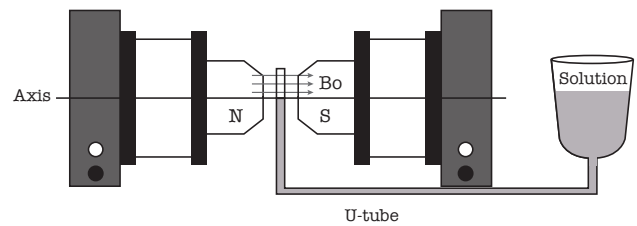

81. Determination of Earth's magnetic field - Tangent galvanometer

In this experiment, we determine the Horizontal component of earth's magnetic field B_H at a place using tangent galvanometer.



82. Magnetic Hysteresis

In this experiment, we trace the magnetic hysteresis (B-H) curve of ferrite material and hence determine the retentivity and coercivity.

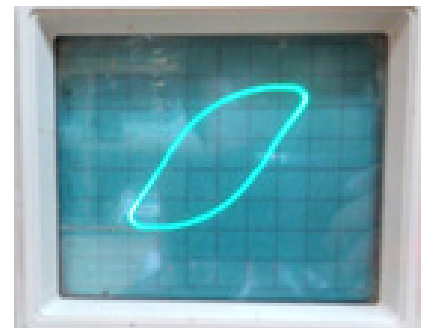

83. Hall effect on semiconductor

In this experiment, we study the Hall Effect phenomenon in a doped semiconductor and hence determine the hall co-efficient and charge Carrier concentration.



84. Peltier Effect

In this experiment, we study the device operation of the Peltier device and to find its physical parameter.

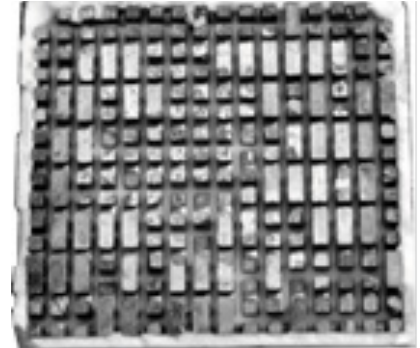
**85. Seebeck Effect**

The Seebeck effect is the conversion of heat directly into electricity at the junction of different types of wire.

**86. Strength of magnetic field due to a solenoid and cylindrical magnet**

To study the magnetic field along the axis of a finite solenoid and compare it with the theory.

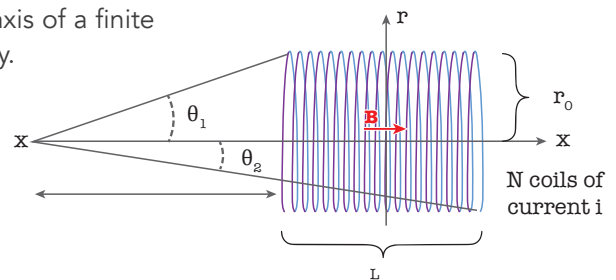
**Mechanics****87. Transformation of energy from one to another**

Conservation energy said that total energy of a system can neither be created or destroyed but it can be transformed from one form to another form. For example, in the case of mechanics, the total energy (potential energy + kinetic energy) is always constant for an object.

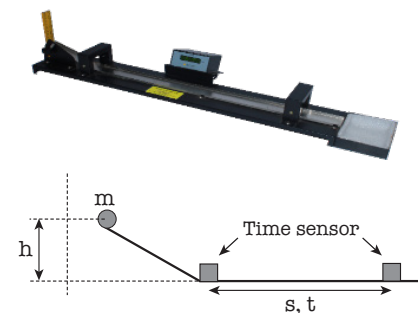
**88. Centre of mass**

Centre of mass of an object (or system of mass particles) is a unique, hypothetical point where entire mass the object may be assumed to be concentrated. It is the point particle equivalent of a given object for application of Newton's laws of motion. At this C.M. point the weighted relative position of the distributed mass sums to be zero.



89. Compound pendulum

In this experiment, we determine acceleration due to gravity and radius of gyration of a compound pendulum bar about its centre of mass.

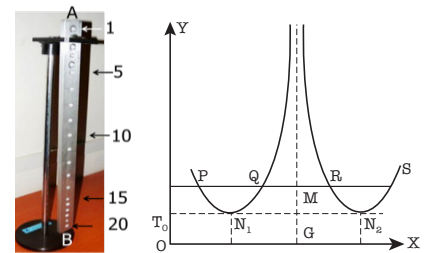

90. Bending Moment

Bending moment is the product of force applied on beam with the distance between the point of application of force and fixed end of the beam.

$$\text{Bending moment} = W x \frac{(l-a)}{l}$$

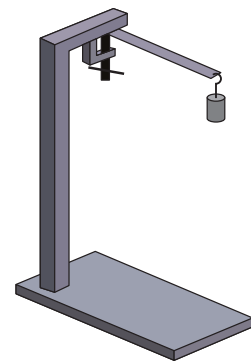

91. Projectile Motion

In this experiment, we find the initial velocity of projectile and study the projectile motion

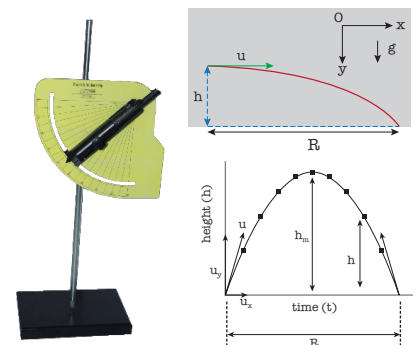

92. Moment bar: Equilibrium of parallel forces

Moment bar: Equilibrium of parallel forces to verify the conditions of equilibrium of parallel forces.

Principle: Sum of clockwise moments = sum of anticlockwise moments, moments taken about any point in their plane.



93. Coefficient of rolling friction

In this experiment, we determine Coefficient of Rolling Friction.

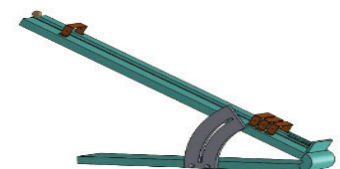

94. Conservation of linear momentum

In this experiment, we verify the law of conservation of linear momentum with the help of the two-dimensional collisions.



95. Atwood's Machine

An ideal Atwood Machine consists of two objects connected by an inextensible massless string over an ideal massless pulley. When both the masses are equal, the machine is in neutral equilibrium regardless of the position of the weights. If both the masses are not equal both masses experience uniform acceleration. In this experiment, we verify Newton's second laws of motion.

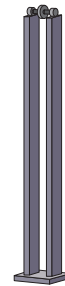

96. Graph plotting and curve fitting

We draw various types of graphs – linear, nonlinear, logarithmic, exponential and distribution functions and electronic orbital using origin software.

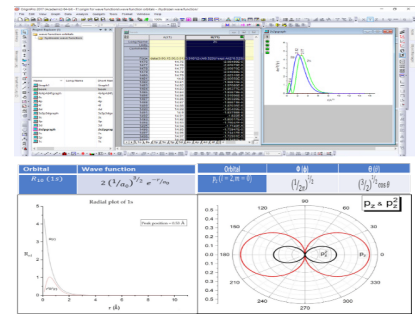

97. Inclined plane – velocity and acceleration of a rolling body

This simple experiment is designed to verify the effect of acceleration on velocity. Consider a spherical ball starts rolling without slipping on an incline plane with inclination of α . Thus, the acceleration acted on the ball is $g \cos \alpha$. By varying the angle of inclination, velocity of the ball will also vary.



98. Moment of Inertia of a flywheel

In this experiment, we determine the moment of inertia of a flywheel.

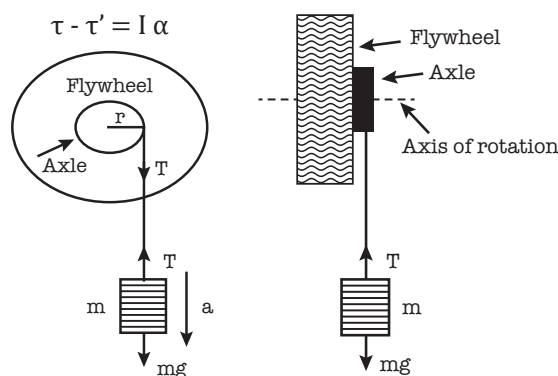

99. Moment of Inertia and Rigidity Modulus

In this experiment, we determine the rigidity modulus of the material of the given wire and determine the moment of Inertia of a disk and dumb bell.



100. Rotational Inertia of a Rigid Body

In this experiment, we measure the rotational inertia of an object by dynamic method.

$$T_l = 2\pi\sqrt{\frac{I_0 + K}{\tau}}$$

Where K is the rotational inertia of the regular body. Replace the regular body by the given irregular body and measure the time period of oscillation T_x .

Rigid Support

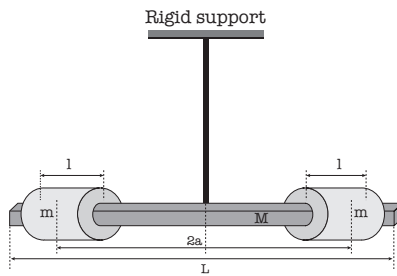
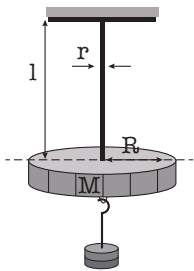

101. Moment of Inertia – Parallel axis theorem

Parallel-axis theorem states that the moment of inertia ($I_{arbitrary}$) about an arbitrary axis is equal to the sum of moment of inertia (I_{CM}) of the object about a parallel axis passing through its centre of mass and product of mass (m) of the object with perpendicular distance (d) between the two axes of rotation. Mathematically $I_{arbitrary} = I_{CM} + md^2$

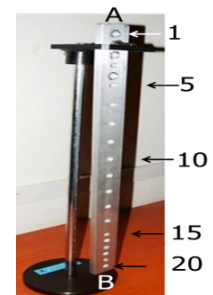

102. Coupled pendulum

In this experiment, we Study the normal modes and resonance of coupled pendulum.

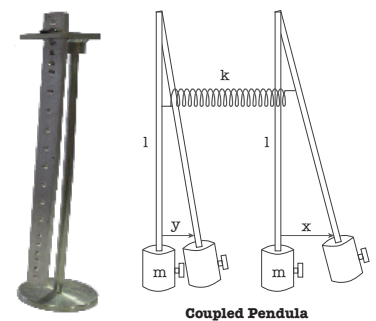

103. Young's Modulus – Searle's Method

In this experiment, we determine the Young's Modulus of the material of the given wire using Searle's apparatus.

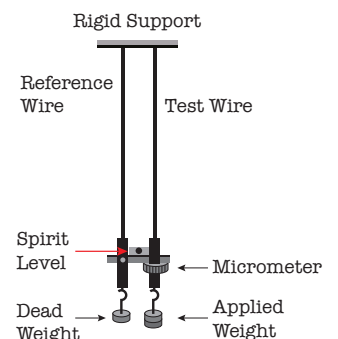

104. Thin Film Preparation

We prepare thin films using sputtering and evaporation deposition techniques.

105. Surface Tension of Water by Capillary Rise

Surface tension is a phenomenon on the surface film of a liquid caused by the cohesive forces among the liquid molecules which tends to minimise surface area. Shape of liquid droplets is responsible by surface tension. Surface tension, T of water can be determined by using the formula.

$$T = \frac{hgr\rho}{2} Nm^{-1}$$

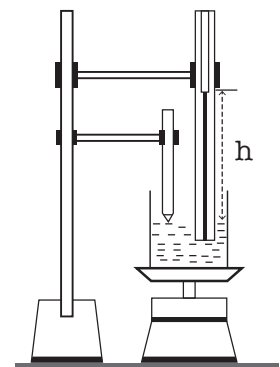
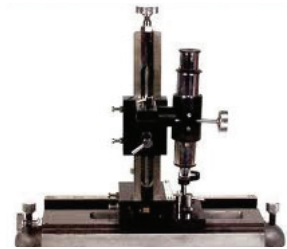

106. Coefficient of viscosity – Stokes' method

In this experiment, we find the coefficient of viscosity of given fluids.

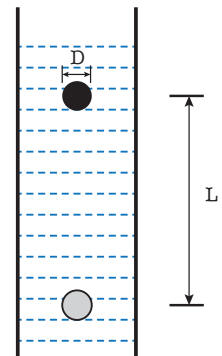

107. Tracker Software

Tracker is a free video analysis and modeling tool built on the Open Source Physics (OSP) Java framework. It is designed to be used in physics education.

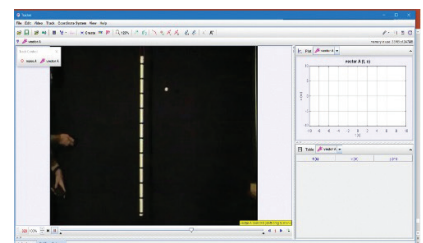

108. Searle's double bar – determination of q , n and σ

In this experiment, we determine the young's modulus (q), modulus of rigidity (n), bulk modulus (K) and Poisson's ratio (σ)

Advance Solid-state Physics

109. X-Ray Diffraction

X-rays with a wavelength similar to the distances between these planes can be reflected such that the angle of reflection is equal to the angle of incidence. We call this behaviour 'diffraction', and it is described by Bragg's Law: $2d\sin\theta = n\lambda$



110. Density of solids and Packing fraction

In this experiment, we determine density of an object, defects and packing fraction.



111. Zeeman Effect

Zeeman Effect is the phenomenon of splitting of a spectral line into two or more component of slightly different frequency when a strong magnetic field is applied to the light source. It was first observed in 1896 by the Dutch physicist Pieter Zeeman as a broadening of the yellow D-lines of sodium in a flame held between strong magnetic poles.

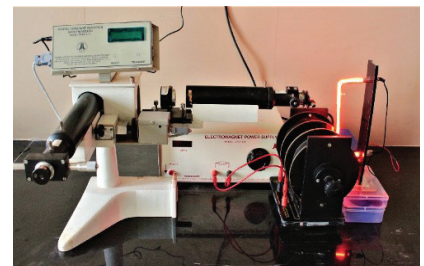

112. Curie Temperature

In this experiment, we study the variation of dielectric constant of ferroelectric ceramic with temperature and to determine its Curie temperature.



113. Synthesis of nanoparticle (ZnS) Synthesis of ZnS nanoparticle and verification by XRD.

114. Superconductor Superconductivity is a phenomenon of zero resistivity and the expulsion of the magnetic fields in materials that are cooled below a certain temperature known as critical temperature.

115. UV Spectroscopy UV-Visible absorption spectroscopy is an important characterisation tools for finding the band gap energy of nanomaterials. From the absorption spectrum, one can find the band gap energy of the nanomaterials with the help of Tauc's plot.

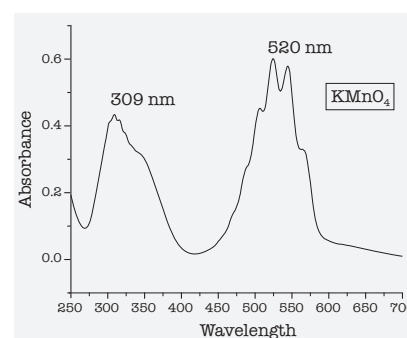

116. Growth of conducting polymer films Conducting polymers are poly-conjugated polymer (having alternate single (σ -bond) and double (π -bonds) bonds known as organic semiconductor (OSC), which can conduct electricity and becomes the possible substitutes for metal. In this experiment, we grow a thin film of doped conducting polymer with different doping concentration.

117. Temperature dependent Resistance of conducting Polymer In this experiment, the resistance of the conducting polymer as a function of temperature is measured and analysed its behaviour. The resistance is measured by four probe methods.

118. Determination of viscosity of liquid

In this experiment, we determine of viscosity coefficient of water by Poiseuille flow method.



119. Current-Voltage characteristics of Polymer devices.

Current-voltage characteristic study of the polymer device is useful for studying the conduction mechanism in organic semiconductor devices. The injection of the charge carriers from the electrode to the polymer and vice versa.

120. Phototransistor characteristics

A phototransistor is a silicon semiconductor device with photosensitive base. It consists of photodiode followed by a transistor. The photodiode supplies base current to the transistor, and the transistor multiplies the base current by its gain. In this experiment, we study the output characteristics of a phototransistor with different LED.

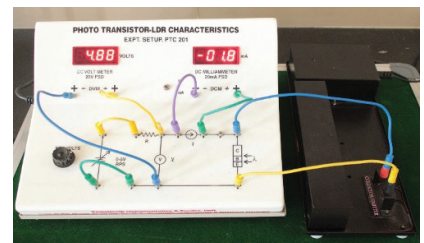

BSc CHEMISTRY EXPERIMENTS

Essential Electronics

**1. Resistivity of metals
– Meter bridge**

Find the resistance and resistivity of different metals using Meter Bridge, a Wheatstone principle. Here we include a kit, which makes it easier to do the experiment.

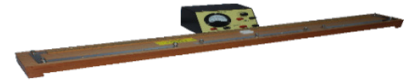
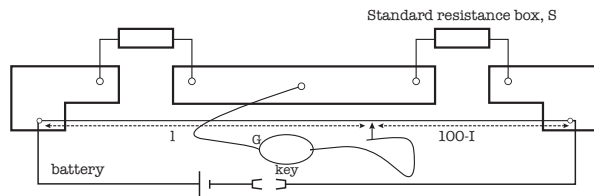

2. Multimeter

Multimeter can be used to measure voltage, current and resistance. It has different ranges in different functions.



**3. Verification of
Ohm's law**

Verify that the current flowing through a conductor is proportional to potential difference across it. From this experiment Ohm's law is verified.



**4. Diode
characteristics**

In this experiment, we draw the forward and reversed bias characteristics curve of rectifier diode and determine the knee voltage and forward bias resistance in a simplified circuit.

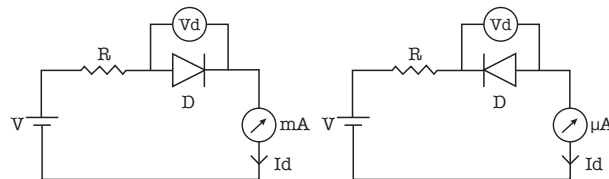

**5. Zener diode
characteristics**

Determine the forward and reversed bias characteristic of a Zener diode and determine the break down voltage by plotting the graph I vs V.

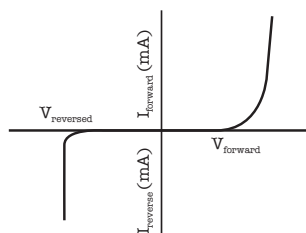

6. To study full and half wave rectifier circuits

Draw the waveform of a half wave and full wave rectifier circuit and compare the Output V_{DC} . by using the multimeter. We observe a half wave and full wave rectifier output through CRO.

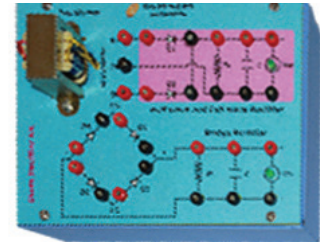
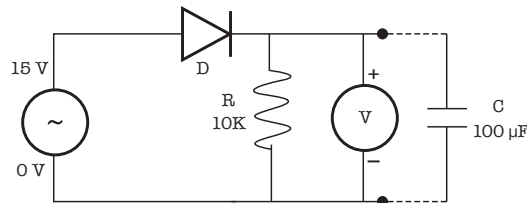

7. Transistor characteristics

We study the input and output characteristic of a given transistor and determine its α and β .

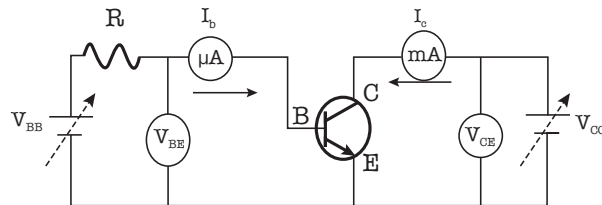

8. Temperature measurement

In this experiment, Mercury thermometer is common thermometer which can be used to measure temperature from -10°C to 360°C . Now it is overtaken by digital Thermometer.



9. Calibration of Chromel – Alumel Thermocouple

On heating the thermocouple, the voltage developed at the junction increases. Using this principle, it is possible to calibrate the thermocouple.

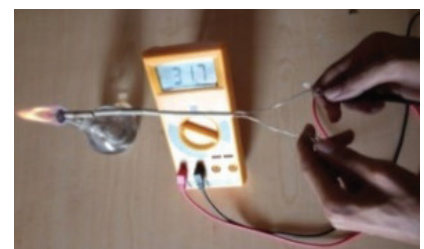

10. Determination of temperature coefficient of Pt_{100}

Plot the graph resistance vs temperature. Nature of the graph is a straight line. Calculate the slope. Then calculate temperature coefficient,

$$\alpha = \frac{\text{slope}}{R_0}$$

where R_0 is resistance at 0°C . The literature value of ' α ' for Pt = 0.003927 K^{-1} .

11. Analogue to Digital conversion and data acquisition

In this experiment, an analogue voltage is converted into digital form and enter the data into a computer. We will also show how temperature measured in mV signal from a thermocouple is now possible to be in the digital computer.



12. Constant current source

In this experiment, we show how a known amount of current can be generated and used as a source of charge for a given period of time for a number of experiments such as determination of Avogadro number, charging a battery.

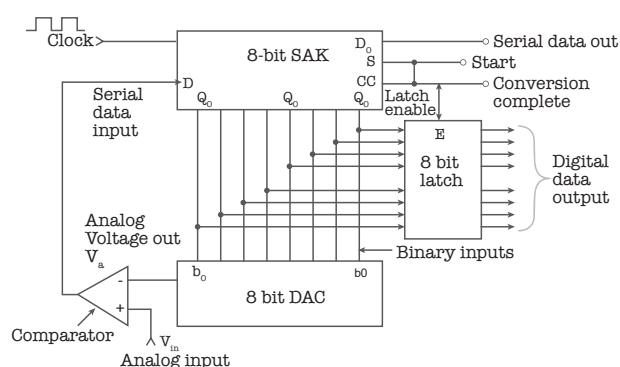

General Chemistry - Atomic Structure

13. Black Body Radiation

In this experiment, we find experimentally that the intensity of radiation increases with wavelength and reaches maximum at a particular wavelength and then decreases exponentially. Solar spectrum is recorded.

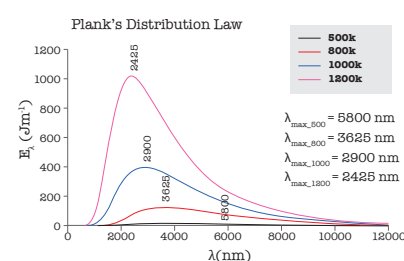

14. Energy of a photon and electromagnetic spectrum

We observe the dispersion of light to determine the wavelength of different colours of light using digital spectrometer and calculate the energy of a photon associated with them. This is an excellent experiment to determine the energy of a photon.



15. Determination of Planck's constant – Photoelectric effect

We determine the Planck's constant using different filters. By plotting a graph frequency vs stopping potential, we can find Planck's constant and work function of photosensitive metal.



16. Hydrogen emission spectra-Energy levels of Hydrogen and determination of Rydberg Constant

In this experiment, we measure the wavelength of the Balmer line from the hydrogen lamp and find the energy of red light of hydrogen emission spectrum = 1.89 eV, Verifying Bohr's theory of light emission from H atom.

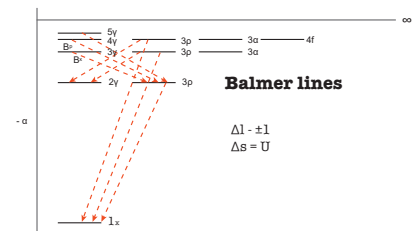

17. Helium emission spectra and Electron states of Helium

Helium emission spectra now matches the energy level scheme and hence the success of Bohr-Sommerfeld model.

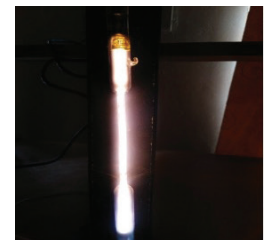

18. Alkali metals emission and energy levels

With $Z > 1$, the n splits into s, p, d and f orbitals. Na emission is due to $3p \rightarrow 3s$. The line is again split into two (doublets) due to spin orbit splitting:
 $^3P_{3/2} - 3S$ and $^3P_{1/2} - 3S$ lines.

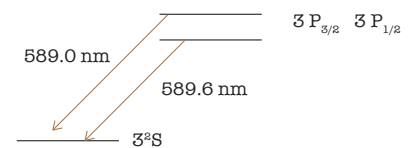

19. Arc spectrum of Zn, Carbon, Al, Cu and Fe

In this experiment, we use Zn, C, Al, Cu and Fe rods. Create emission by producing arc you can record emission spectra from these elements and assign the emission lines.

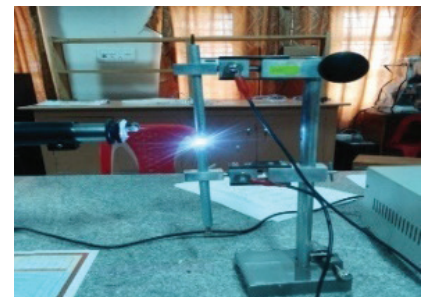

20. Flame Spectroscopy

Flames can be generated with metal ions and emission line of atoms of most metals can be recorded using an emission fiber optics.

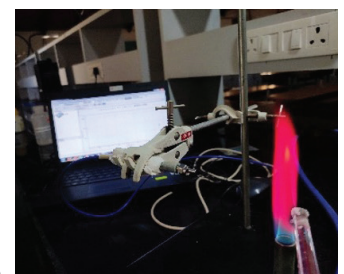
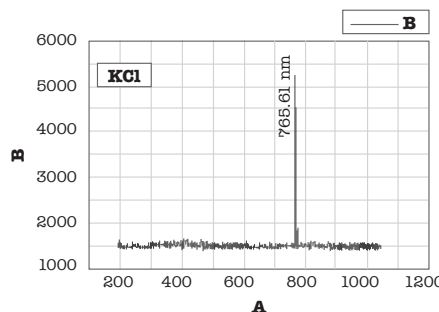

21. Moseley's law

Mosley's law states that square root of $K\alpha$ radiation is proportional to atomic number. Starting from $Z = 1$. You can verify this by plotting the data.

22. Plotting atomic orbitals

Solution of Schrodinger equation of Hydrogen atom finally leads to radial part of the wave function of the electron and angular part of the wave function of the electron.

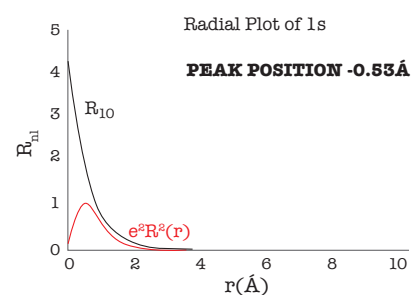
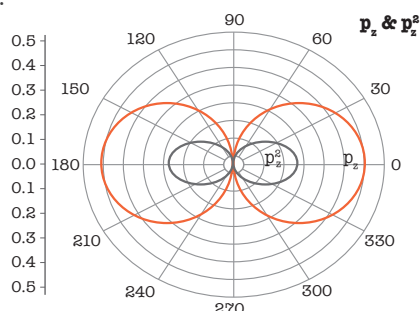
**23. Plotting hybrid orbitals**

Hybrid orbitals sp , sp^2 , sp^3 , dsp^2 and dsp^3 can all be plotted to see how a hybrid orbital gives line in a radial plot. It can be carried out by participants using ORIGIN programs.

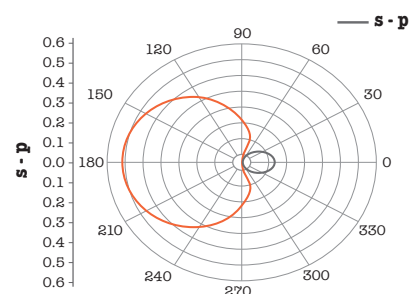
**Chemical Reactions****24. Preparation of Gases and their chemical reactions**

Take about 10 g of marble chips in the round bottom flask. Add 10 mL of dil. HCl to the flask. Collect the carbon dioxide produced in a test tube by upward displacement of air.

**25. Reaction of metals with mineral acids**

In this experiment, we study the reactions of dil. hydrochloric acid, reactions of dil. sulphuric acid with different metals. And we prepare oxides of nitrogen.

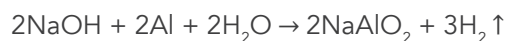
**26. Reactions of metals with sodium hydroxide**

Zinc also reacts similarly with NaOH liberating hydrogen and forming sodium zincate, Na_2ZnO_2 .

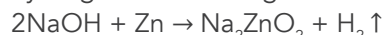

(Na_2ZnO_2 is called as Sodium zincate).

27. Reducing agents and reduction of oxides	Using charcoal, copper oxide can be reduced to copper metal. Here charcoal is the reducing agent, which reduces copper oxide to copper. $\text{CuO}(\text{Cu}^{2+}) + 2\text{e}^{-} \rightarrow \text{Cu}$
28. Reduction of permanganate and dichromate by nascent hydrogen	Hydrogen is produced by the reaction of Zn metal with dil. H_2SO_4 . To the reaction mixture add very dilute solution (about 0.05 N) of KMnO_4 and observe the color change due to reduction of KMnO_4 . $2\text{KMnO}_4 + 3\text{H}_2\text{SO}_4 + 5\text{H}_2 \rightarrow \text{K}_2\text{SO}_4 + 2\text{MnSO}_4 + 8\text{H}_2\text{O}$
29. Enthalpies of displacement reactions	In this experiment, we use equal number of moles of Fe and Mg, and measure which one of the reactions liberates more heat? Which one of the reactions has a greater enthalpy of reaction?
30. Reactions of Hydrogen Peroxide	In this experiment, we carry out the Reaction with potassium iodide – Peroxide as an oxidising agent, Reaction with silver oxide - Peroxide as a reducing agent, Reaction with Chlorine gas, Reaction with KMnO_4 and $\text{K}_2\text{Cr}_2\text{O}_7$.
31. Preparation of Inorganic Complexes	In this experiment, we carry out the preparation of Prussian blue complex, Reaction of Cu^{2+} With NH_3 , Reaction of ammonium thiocyanate with ferric chloride, Reaction of CoCl_2 with conc. HCl.
32. Redox Reactions	In this experiment, we carry out reaction of sodium thiosulphate with conc. HCl, reaction between $\text{K}_2\text{Cr}_2\text{O}_7$ and KOH, reaction between K_2CrO_4 and HCl.
33. Decomposition Reactions	In this experiment, we carry out the preparation of oxygen by decomposition of KMnO_4 , decomposition of potassium chlorate in the presence of catalyst MnO_2 , Thermal decomposition of Sodium bicarbonate.
34. Chemical Reactions	In this experiment, we carry out the reaction of Br_2 with KI solution; distinguishing Fe^{2+} and Fe^{3+} , Testing of iodine content in common salt; reaction of sodium sulfide with cobalt (III) nitrate; reaction of sodium with water; and solid-state endothermic reaction (reaction between $\text{Ba}(\text{OH})_2$ and NH_4Cl).

Gas Laws and Thermodynamics

35. Measurement of atmosphere pressure by Hg barometer

In this experiment, we measure atmospheric pressure using mercury manometer. $P = \rho gh$ Pa. A new method of measuring pressure is by using pressure transducers. These pressure transducers are commonly manufactured out of piezoelectric materials such as quartz. When pressure is applied on a crystal, because of pressure difference, voltage develops.

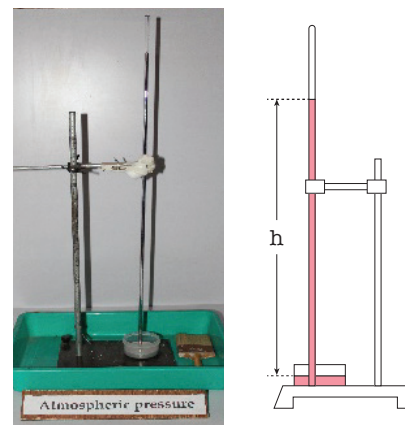

36. Boyle's law

In this experiment, we verify Boyle's law by changing pressure and volume at constant temperature; i.e., PV is constant at constant temperature. Here we use water column to find the pressure instead of mercury column. This is our a new innovation experiment.

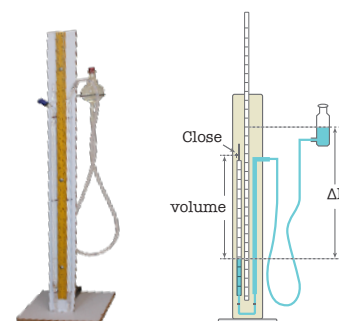

37. Gas Law (Gay-Lussac law) / Charles' Law:

In this experiment, we verify the Charles' law and GayLussac law by changing the pressure and temperature at constant volume by using water column and manometer. And plotting graph P vs T to find absolute temperature.

38. Determination of Absolute Zero

In this experiment, we study the relationship between pressure and temperature of given gas under constant volume and to find absolute zero. This is another verification of Charles' law. Plot P vs T, it gives absolute zero.



39. Determination of universal gas constant R

In this experiment, we determine Universal gas constant R using the equation, $PV = nRT$.

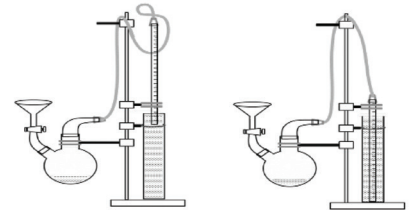

40. Determination of C_p/C_v for different gases using Resonance Column

In this experiment, velocity of sound V_s at room temperature can be determined using resonance column by, $V_s = 2f(l_2 - l_1)$
The velocity of sound in any gas is given by

$$V_s = \sqrt{\gamma RT / M}$$

By measuring the V_s in different gases in the resonance phenomenon, C_p/C_v of the gas can be determined.

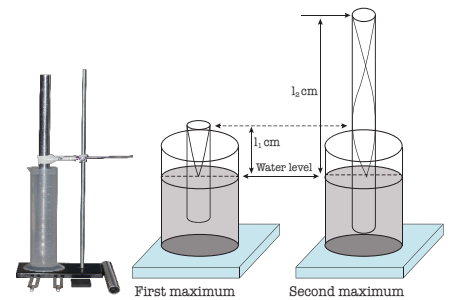

41. Linear thermal expansion coefficient

We determine linear coefficient of thermal expansion of wire by applying current to wire to expand. By applying Pythagoras one can find linear coefficient of thermal expansion of a metal. This Apparatus measure 1 mm in 1000 mm accurately.

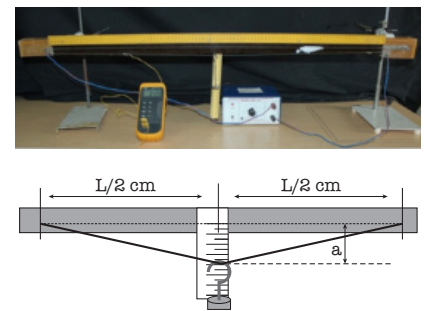

42. Volume expansion coefficient of liquid

In this experiment, we determine volume expansion coefficient of water and different liquids. Here we use a graduated glass tube to determine volume expansion coefficient of liquid.

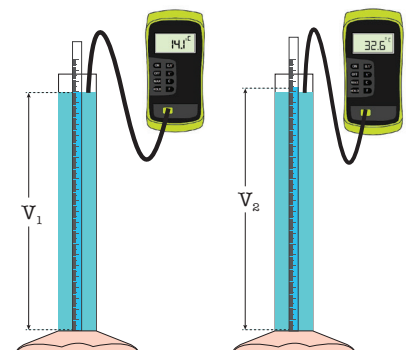

43. Specific heat of liquid

In this experiment, we measure the specific heat capacity of water.

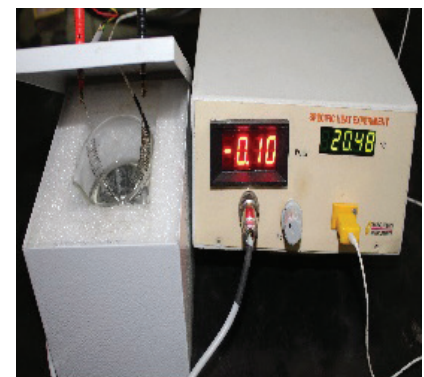

44. Specific heat of metals

In this experiment, we determine specific heat of solids by the method of mixtures. Principle of method of mixtures is Heat gained = Heat lost.

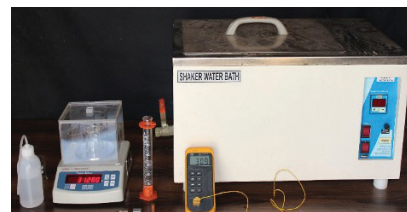

45. Latent heat of fusion of ice

If we supply heat to a solid ice then it can convert from solid state to liquid state without changing its temperature. The heat energy released or absorbed by an object during a thermodynamic process without changing its temperature is called latent heat. Ice changes its phase to water at 0°C. Latent heat of fusion or enthalpy of fusion of ice is the amount of heat released per kg of ice.



46. Enthalpy of neutralisation

In this experiment, we determine enthalpy of neutralisation of H_2SO_4 with NaOH by calorimetric method by assuming specific heat of Na_2SO_4 solution is the same as that of water and the total volume of water is the same as the total volume of the solutions. Then, heat energy released, enthalpy of neutralisation is calculated.



47. Variation of vapor pressure of water with temperature

In this experiment, water vapor must be in equilibrium with liquid water at any given temperature from 0°C to 100°C. Thus, the glass bulb is immersed in water and heated. The vapor pressure is measured using pressure gauge Plot $P_{\text{H}_2\text{O}}$ vs temperature.

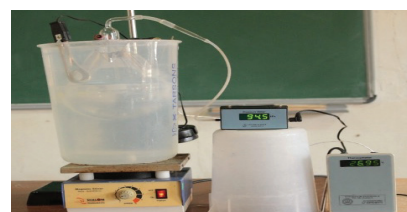

48. Determination of latent heat of vaporisation using Clausius – Clapeyron equation

The specific entropy 's' for a homogeneous substance is a function of specific volume 'v' and temperature T

$$ds = \left(\frac{\partial s}{\partial s}\right)_T dv + \left(\frac{\partial s}{\partial T}\right)_v dT$$

The Clausius-Clapeyron relation characterises behaviour of a closed system during a phase change, during which temperature and pressure are constant.



49. Determination of ΔH° and ΔS° of $\text{CaO-H}_2\text{O}$ system

$\Delta G_r^\circ = \Delta H^\circ - T\Delta S^\circ$ At any temperature ΔH° remains constant. Solve for ΔH° and ΔS° using two of equations obtained at two different temperatures.



50. Determination of molal boiling point elevation constant

Determination of molal boiling point elevation constant, K_b , of solvents using Urea in Ethanol, Camphor in Cyclohexane and NaCl in water.



51. Determination of boiling points of mixtures of liquids with different compositions

In this experiment, we determine boiling points of mixtures of Acetone-Water and Ethanol-Water systems.

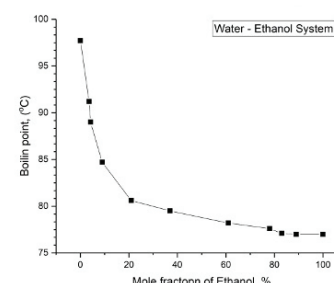

52. Determination of molal freezing point depression constant

Take ice in a plastic bowl and place on a magnetic stirrer. Take about 25 mL of water in a 50 mL beaker. Place a magnetic bead in the beaker. Place the beaker inside the freezing mixture. Place the tip of a digital thermometer thermocouple in the water. Start a uniform stirring. Start a stop watch. Note the temperature as a function of time. Take several readings after reaching apparently the freezing point. Plot a graph of temperature vs. time to find the freezing point.



53. Determination of osmotic pressure and Reverse Osmosis – Issues of Drinking water

In this experiment we show generation of osmotic pressure and how the concept is used to get drinking water by reverse osmosis.

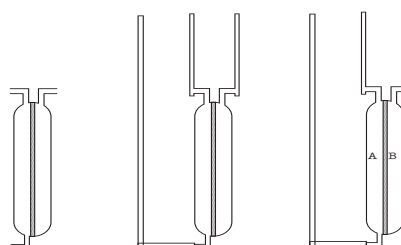

Electrochemistry

54. pH titration of HCl with NaOH

In this experiment, we determine the concentration of NaOH by performing pH titration against HCl.

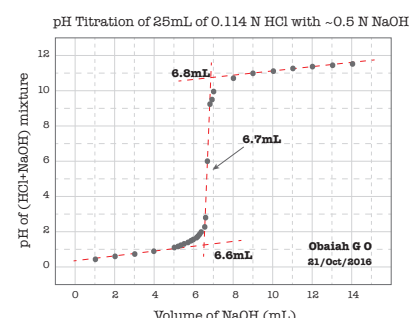

55. Determination of pK_a of acetic acid by pH titration

In this experiment, we determine pK_a of acetic acid by pH titration using chemicals Glacial acetic acid, NaOH.

56. Determination of pK_a of Dichloroacetic acid by pH titration

In this experiment, we determine the pK_a of dichloroacetic acid by pH titration using the chemicals dichloroacetic acid, NaOH.

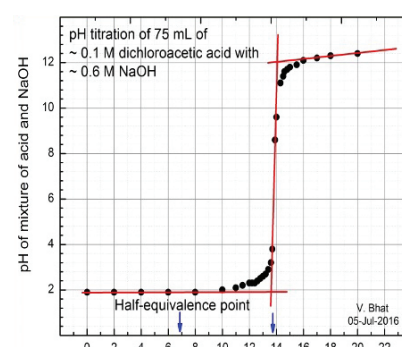

57. Determination of pK_a of the conjugate acid of Ammonia by pH titration

In this experiment, we determine the pK_a of conjugate acid of ammonia by pH titration using the chemicals NH_4Cl , NaOH.

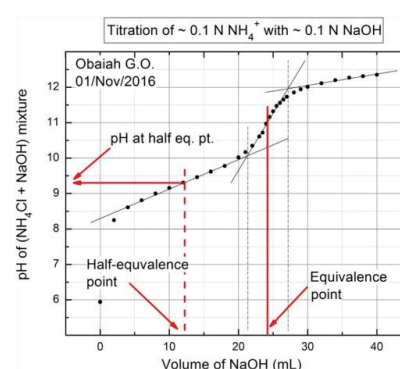

58. Determination of pK_a of Aniline hydrochloride by pH titration

In this experiment, we determine the pK_a of aniline hydrochloride by pH titration using the chemicals aniline hydrochloride, NaOH.

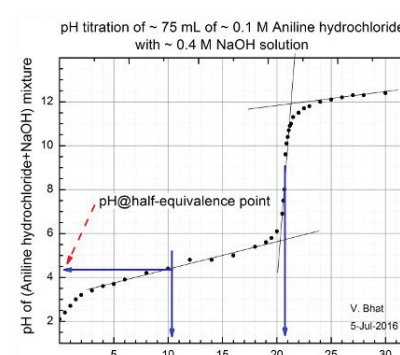

59. Determination of pK_a of phenol by pH titration

In this experiment, we determine the pK_a of phenol by pH titration using chemicals Phenol, NaOH.

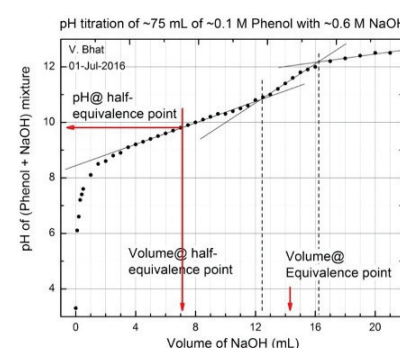

60. Determination of pK_{a1} and pK_{a2} of Oxalic acid by pH titration

In this experiment, we determine the pK_{a1} and pK_{a2} of oxalic acid by pH titration using chemicals Oxalic acid, NaOH.

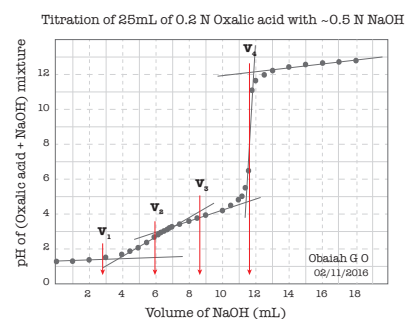

61. Determination of pK_{a1} , pK_{a2} and pK_{a3} of Phosphoric acid by pH titration

In this experiment, we determine the pK_{a1} , pK_{a2} and pK_{a3} of phosphoric acid by pH titration using NaOH.

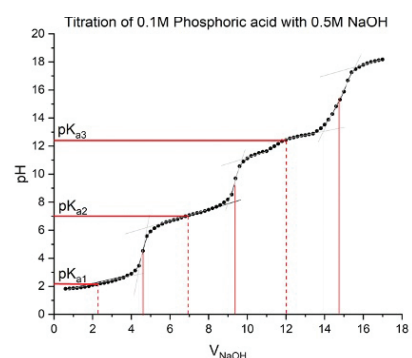

62. Determination of pK_{a1} and pK_{a2} of glycine by pH titration

In this experiment, we determine the pK_{a1} and pK_{a2} of glycine by pH titration of glycine hydrochloride with NaOH.

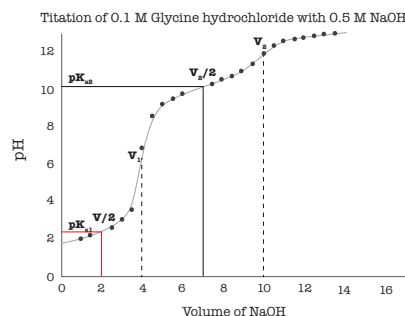

63. Acidic and basic buffers: Preparation of (A) acetic acid-sodium acetate and (B) ammoniaammonium chloride buffers

In this experiment, we prepare the different buffer and measure its pH.

64. Preparation and testing the buffer action of Phosphate buffers

In this experiment, we prepare the phosphate buffer and testing its action by doing titration against acid and base.

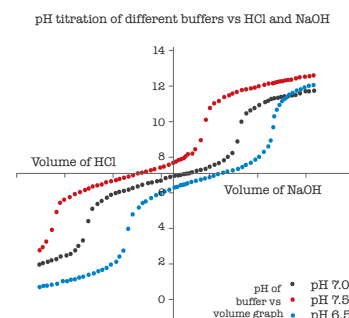

65. Conductometric titration of HCl with NaOH

In this experiment, we determine the concentration of NaOH by conductometric titration against HCl.

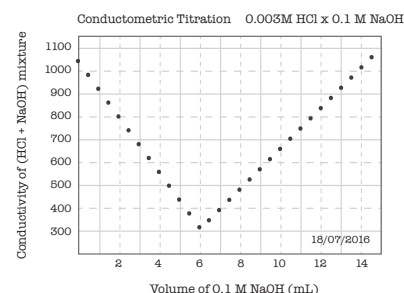

66. Determination of Equivalent Conductance at infinite dilution of a strong electrolyte

In this experiment, we determine the equivalent conductance at infinite dilution of a strong electrolyte using 0.5 N NaCl, 0.5 N KCl and 0.5 N LiCl solutions in distilled water.

67. Kohlrausch law

Kohlrausch's law states that the equivalent conductivity of an electrolyte at infinite dilution is equal to the sum of the conductance of the anions and cations. If a salt is dissolved in water, the conductivity of the solution is the sum of the conductance of the anions and cations. In this experiment, we determine the equivalent conductance at infinite dilution of Acetic acid.



68. Ostwald's Dilution Law: Determination of Dissociation Constant of Weak Acid

In this experiment, we verify the Ostwald's Dilution Law and determine the dissociation constant of given weak electrolyte.

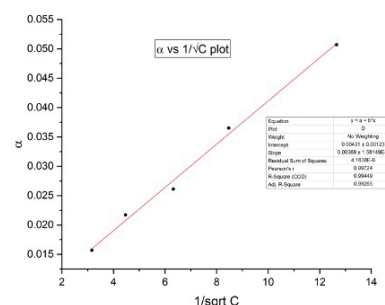

69. Precipitation Titration and Solubility of sparingly soluble salt

In this experiment, we follow conductometrically the titration of an aqueous solution of barium chloride against sodium sulphate solution. And determine the solubility of barium sulphate.

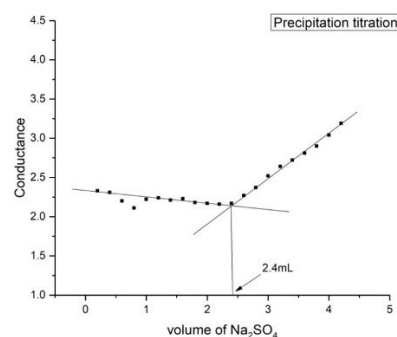

70. Titration of a mixture of strong and weak acid with a strong base

In this experiment, we determine the concentration of a strong acid and a weak acid present in a mixture using, standardised NaOH solution (0.05 N), HCl solution (0.001 N) and Acetic acid (0.01N) solution.

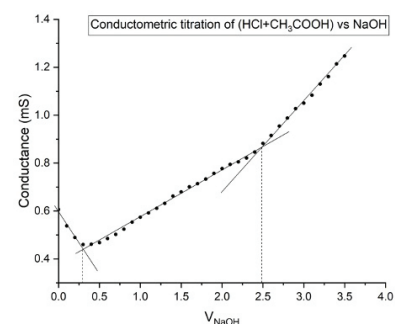

71. Determination of solubility product for AgCl, AgBr and AgI

In this experiment, we calculate $[Ag^+]_{AgCl}$ and solubility product 'S' using following equation .

$$E = 0.059 \log\left(\frac{[Ag^+]_{AgNO_3}}{[Ag^+]_{AgCl}}\right)$$

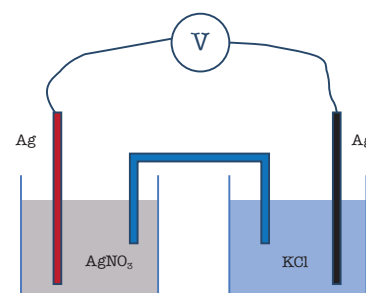

72. Determination of electrode potentials

In this experiment, we measure potentials of Zn²⁺ / Zn, Cu²⁺ / Cu, Ag / Ag⁺ and Ni / Ni²⁺ half cells.

73. Battery charge-discharge cycling

In this experiment, we find energy delivered during discharge and recharge of batteries.

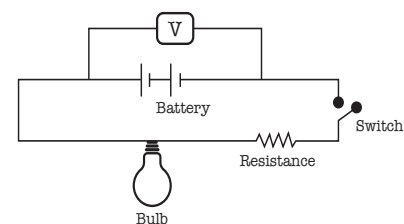

74. Determination of Avogadro number

In this experiment, electrodeposition of copper is used to determine Avogadro number. A known quantity of electricity is passed through copper sulphate solution using copper plate as anode and stainless steel as cathode. The mass of copper deposited is proportional to the quantity of electricity passed.



75. Estimation of Iron using Potassium dichromate by potentiometric titration

In this experiment, we find out the strength of the given FAS solution by titrating against K₂Cr₂O₇ solution potentiometrically.

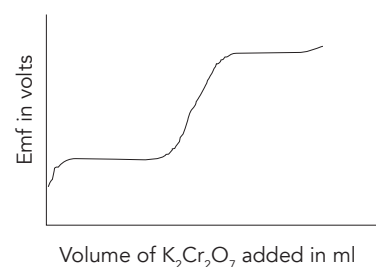

76. Cyclic Voltammetry

Cyclic voltammetry is an electroanalytical technique to study electroactive chemical species. It is helpful to understand the fundamental information of redox reactions.

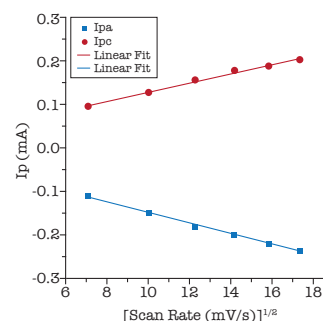
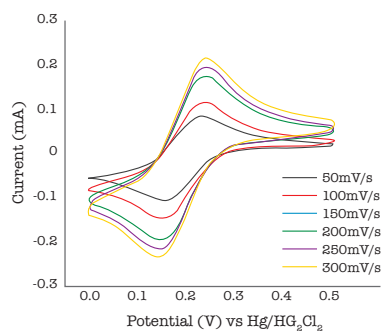
**77. Battery Technology**

Dependence of electrode potentials of metal/metal ions and other redox couples to make batteries will be demonstrated. Teachers will construct batteries.

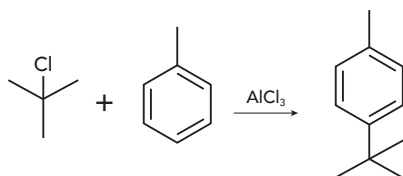
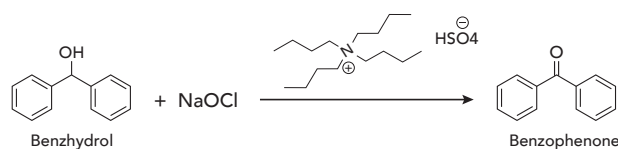
Organic Chemistry**78. Friedel-Craft Alkylation****79. Oxidation of Benzhydrol to Benzophenone****80. Reduction of Acetophenone**

In this experiment, conversion of acetophenone to acetophenol using sodium borohydride as reducing agent and methanol as solvent is carried out.

81. Synthesis of Dibenzylidene Acetone – A typical Aldol Reaction

Synthesis of Dibenzylidene Acetone by aldol condensation of benzaldehyde and acetone in presence of sodium hydroxide is carried out.

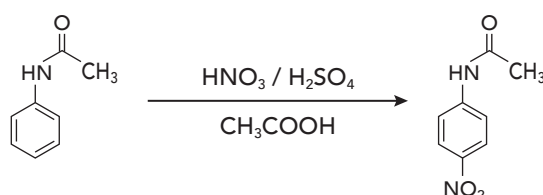
82. Synthesis of p-nitro acetanilide by nitration of acetanilide

83. Synthesis of N-methyl benzamide

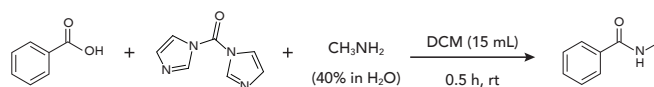

84. Diazotisation reaction and azo-coupling Synthesis of Diazoaminobenzene

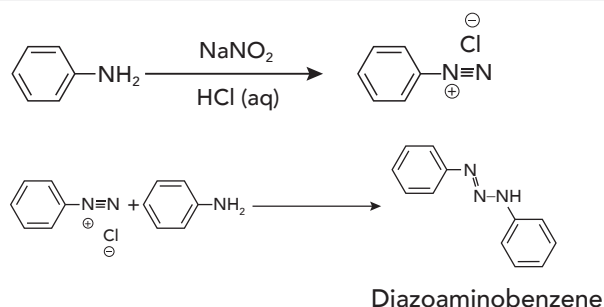

85. Reduction of 4-nitroaniline using Nickel nano-particles

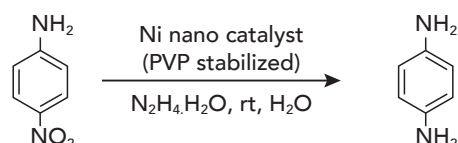

86. Thin layer chromatography

Thin layer chromatography (TLC) is a chromatography technique used to separate mixtures, monitor the reaction progression, identify compounds present in a given mixture, and determine the purity of a substance.



87. Column chromatography

Column chromatography is one of the most useful techniques for purifying compounds. This technique utilises a stationary phase, which is packed in a column, and a mobile phase that passes through the column.



88. Qualitative analysis of Organic Compounds

In this experiment, we carry out qualitative analysis of given organic compounds.

89. Interpretation of UV visible, NMR, Mass and IR Spectra

In this experiment, interpretation of structure for given UV visible, IR, NMR, Mass spectra of organic compound is given.

90. Polarimetry

In this experiment, characterisation of optically active compounds will be done.

Molecular Spectroscopy and Complexes

91. Verification of Beer Lambert law

- In this experiment, we prepare $\text{Fe}(\text{NO}_3)_3$ solution, NH_4SCN solution, HNO_3 solution, standard solutions. Measure the absorbance and find the standard deviation.
- Determination of molar extinction coefficients of (A) KMnO_4 and (B) MnCl_2 in aqueous solutions.
- Allowed and forbidden transitions.
- UV-Visible absorption spectra of KMnO_4 and MnCl_2 in aqueous solutions.

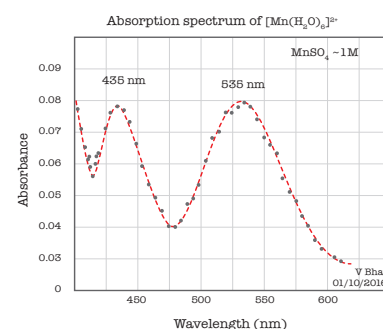
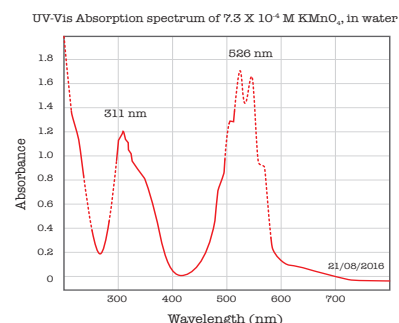

92. UV-Visible absorption spectra of d^1 systems. $[\text{Ti}(\text{H}_2\text{O})_6]^{3+}$ and VO_2^+

Prepare Ti^{3+} and V^{4+} solutions and record the absorption spectra. Find out 10Dq.

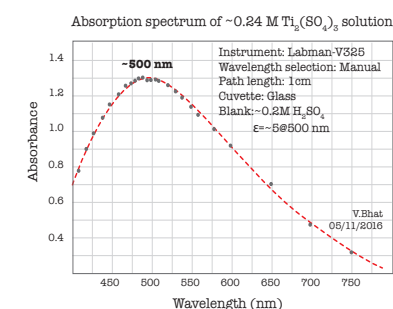
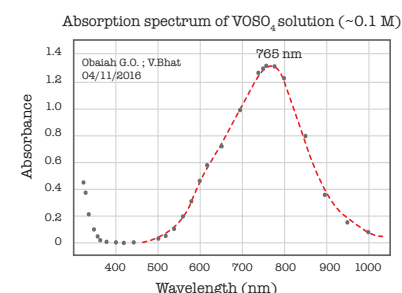

93. Calculation of 10Dq for d^9 systems UV-Visible absorption spectra of $[\text{Cu}(\text{NH}_3)_4(\text{H}_2\text{O})_2]^{2+}$ and $[\text{Cu}(\text{H}_2\text{O})_6]^{2+}$

Record absorption spectra of solutions and calculate 10Dq. Also assign the transitions.

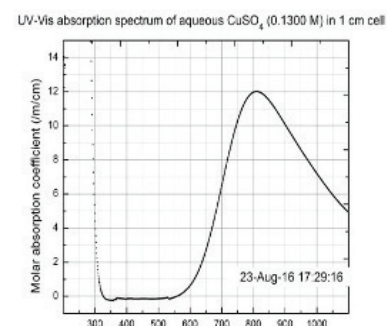
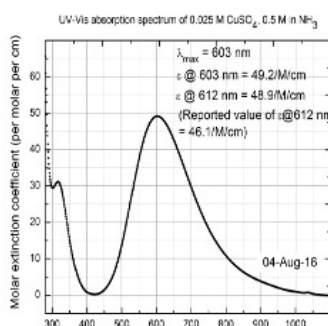

94. Assignment of peaks to specific electronic transitions in the UV-Visible absorption spectra

Record absorption spectra of $[Ni(H_2O)_6]^{2+}$ and $[Ni(NH_3)_6]^{2+}$ and assign the peaks.

Observe the spectrochemical effect.

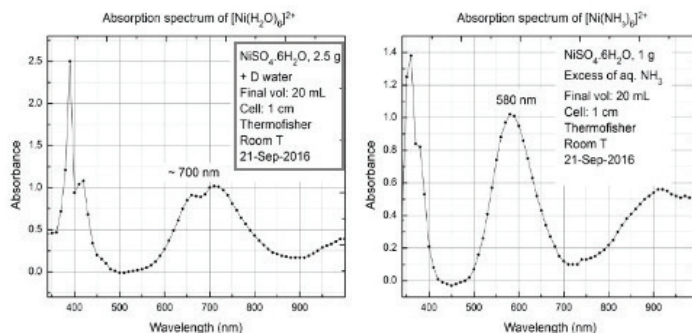

95. Weak field and strong field ligands. UV-Visible absorption spectra of Ni^{2+} with H_2O , NH_3 , and (en) as ligands

In this experiment, we prepare the solution required for recording UV-Visible absorption spectrum of $[Ni(en)_3]^{2+}$ and record the spectrum. Calculate the 10Dq values for all three complexes.

96. Molecular orbital energy level diagram

Assignment of peaks and determination of Δ in $KMnO_4$

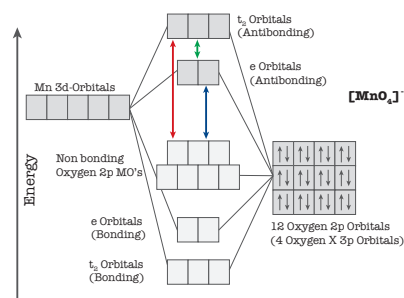
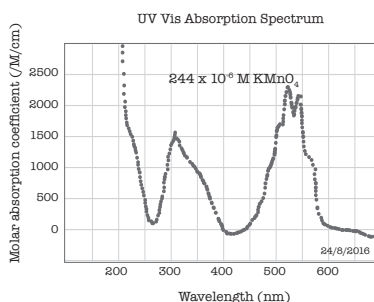

97. Ligand to Metal Charge Transfer Spectra. UV-Vis absorption spectra of K_2CrO_4 and $K_2Cr_2O_7$

Here ligand to metal charge transfer spectra are studied by taking d^0 Cr ion.

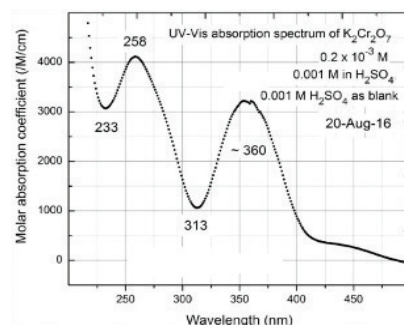
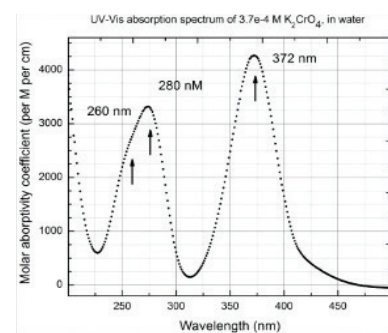

98. Complementary colours – Correlation of absorption spectra to colours

If a compound absorbs green light, the compound appears red to our eyes. This is verified in this experiment.

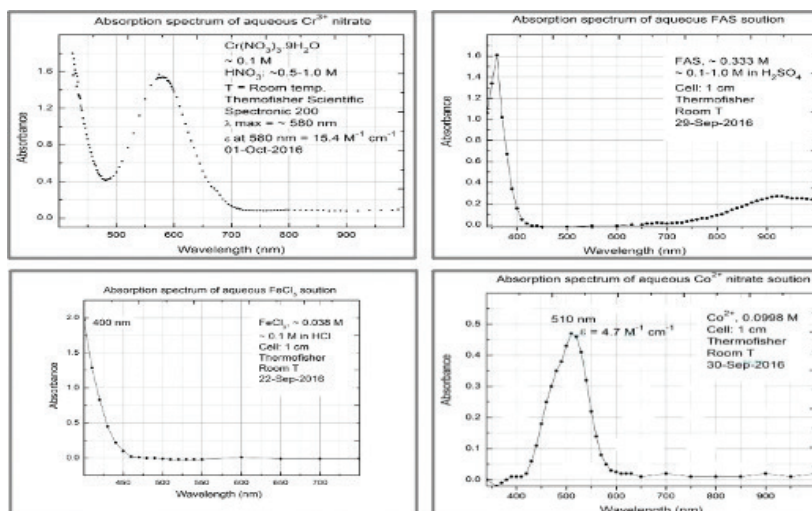

Solid-State Chemistry and Catalysis

99. Temperature coefficient of resistance, α , of metal

Resistance of metals increases with increasing temperature. In this experiment, we find the variation resistance of Cu wire with temperature.

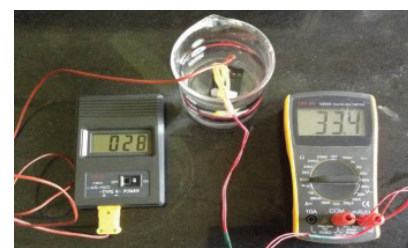

100. Temperature Dependence of Resistance of Semiconductor Determination of Energy Band gap, E_g

Semiconductors are the basic blocks of today's electronics. Unlike metals, the electrical resistivity of a semiconductor material decreases with increasing temperature. In this experiment, we examine the temperature variation of resistance of a semiconductor.

101. Determination of linear dimensions and density of solids and liquids

In this experiment, we measure the dimensions of rectangular, cylindrical and spherical objects and determine mass by using a digital balance and determine density in g/cc and kg/m^3 .



102. Determination of defect concentration by Density measurement method

By buoyancy method, densities of NaCl powder and NaCl crystal will be measured. Find that powder density is lower than the single crystal of NaCl , which is close to theoretical density.

103. Indexing an XRD pattern – Determination of Density by X-ray method

In this experiment, we will show how to find lattice parameter of metals crystallising in cubic structures. Powder X-ray diffraction pattern is recorded in a diffractometer and the diffraction lines are indexed. From the indexed pattern, lattice parameter, packing fraction, atomic radius, density of metals such as Al, Fe, Pt, Cu and also compounds such as NaCl and many other compounds are obtained.

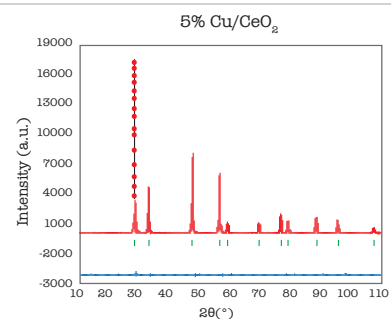

104. Preparation of Nano Materials by Solution Combustion Method

In this experiment, we prepare of CeO_2 by combustion method. It is done to obtain Nano-crystalline solid determined by the width of X-ray diffraction line.



105. Temperature programmed reduction – Hydrogen uptake

Temperature programmed reduction is a powerful method to find reducibility of an oxide such as CuO . Determination of oxygen storage capacity of an oxide will be demonstrated.

106. Langmuir Adsorption

Hydrogen adsorption over Pd or Pd ion substituted TiO_2 will be demonstrated in this experiment.

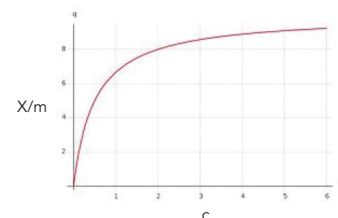

107. Estimation of Oxygen in MnO_2 and CuO

By iodometric titration method, oxygen in CuO , MnO_2 will be determined by the participants.

108. Kinetics measurement of acid catalysed Ethyl acetate hydrolysis



$$\ln \frac{k_2}{k_1} = \frac{E_a}{R} \left[\frac{1}{T_1} - \frac{1}{T_2} \right]$$

109. Kinetic measurement of hydrolysis of t-butyl chloride

Following the conductivity of solution in water, rate of hydrolysis is determined.

110. Kinetics of Oxidation of Alcohol by Potassium Dichromate – Spectrophotometry

In this experiment, we determine the rate constant for the oxidation of ethanol by potassium dichromate.

BSc BIOLOGY EXPERIMENT

The manual of BSc Biology experiments has been divided into eight major topics, which will be covering all the major BSc experiments for the entire three-year degree program. Initially the teacher will be doing the PU experiments afterwards other experiments will be carried out.

Botany

1. **Anatomy of plant cells and tissues** To understand anatomy of plant, tissues are group of similar cells, having the same origin and performing a specific function. The classification is based on structure, location and function.

2. **Study of inflorescence** To study different types of inflorescences. An inflorescence is defined as a group or collection of flowers. In many cases, the individual flowers are inconspicuous and by themselves will not be able to attract the attention of pollinating agents. Under such circumstances they group together and form clusters called inflorescence. Based on the growth and pattern of arrangement of flower, inflorescences are categorised into various groups like racemose inflorescence (indefinite inflorescence): and cymose inflorescence (cyme, definite inflorescence)



3. **Flower morphology and floral diagrams** A flower is the reproductive unit in the angiospermic plants. It is meant for sexual reproduction. A typical flower has four different kinds of whorls namely calyx, corolla, androecium and gynoecium. They are arranged successively on the swollen end of the pedicel called thalamus or receptacle. Calyx and corolla are accessory organs, while androecium and gynoecium are reproductive organs. A flower having both androecium and gynoecium is referred as bisexual flower. A flower having either one of those is called unisexual flower. A flower having all the whorls is known as a 'Complete flower' where as a flower missing anyone or more whorl is referred as an 'Incomplete flower'.

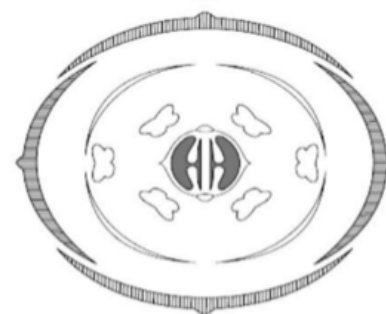

4. **Pollen germination test** To understand the germination of pollen grains. In flowering plants, however, the ovules are contained within a hollow organ called the pistil, and the pollen is deposited on the pistil's respective surface, the stigma. On the stigma, the germination of pollen grains begins by absorption of water and nutrients and the pollen grain produces a tiny pollen tube through the style to the ovary. The tube cell enlarges and comes out of the pollen grains through one of the germ pores to form a pollen tube. The tube nucleus descends to the tip of the pollen tube.



5. Study of cell division

To understand the process of cell division.

Mitosis: To study stages of mitosis in onion root tip. A cell divides mitotically to form two daughter cells. The ability of cell to divide is called totipotency. In plants, such divisions rapidly take place in meristematic tissues of root and shoot where the stages of mitosis can be easily observed.

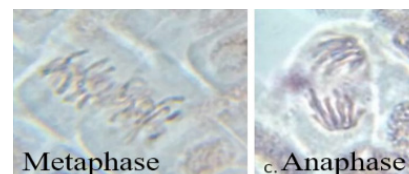

Meiosis: Meiosis, which is referred to as reduction division, is the form of cell division in which a cell divides into four daughter cells each of which has half of the number of chromosomes of the original cell. Meiosis occurs prior to the formation of sperm (in males) and ova (in females). That is meiosis only occurs in the "gametes". The chromosomes of the grasshoppers have been used for a vast number of cytological studies.

6. Effect of sunlight on chlorophyll synthesis and plant growth hormone synthesis

Conversion of proplast into chloroplast requires light. If sufficient light is not available plants become yellow, the process is called etiolation. The process of chloroplast development and accumulation of chlorophyll is light dependent. Under darkness plants are capable of synthesising more amount of plant growth regulators which influences the plant growth.



7. Isolation of chlorophylls

The chlorophylls are the essential components for photosynthesis and occur in chloroplasts as green pigments in all photoautotrophic organisms. Chemically, each chlorophyll molecule contains a porphyrin (tetrapyrrole) nucleus with a chelated magnesium atom at the centre and a long-chain hydrocarbon (phytyl) side chain attached through a carboxylic acid group. Chlorophylls a and b occur in higher plants, ferns and mosses. Chlorophylls c, d and e are only found in algae and certain bacteria.

8. Study of placentation in plants

Placentation is organic connection between developing embryo with the mother plant. The attachment of an ovule to the ovary wall is done by placenta. If there is only one ovule in the ovary then it is usually attached either at the base (basal placentation) or the apex (apical placentation). In a compound ovary the ovules may be attached either on a central axis or on the wall along the junctions of the carpels (parietal placentation). There are different kinds of placentation. Like Marginal placentation (Ventral placentation), Axile placentation, Parietal placentation and Basal placentation



9. Dry seed examination Purity and healthy seeds are requirements in agriculture. Various seed associated pathogens will be able to cause discoloration of the seeds and affect germination. Presence of weed seeds can cause problems in crop management. So, to inspect the seeds for contaminants by dry seed examination.

10. Seed wash method Seeds carry fungi on external surface. Rapid detection of externally seed borne fungi is possible by observing seed wash.

11. Seed health testing To detect seed borne fungi by blotter method. Fungi are major pathogens of plants. They are transmitted through seed both externally and internally. In this method, when moisture is provided to seed, they imbibe water. The fungi present in and on it get expressed as seed itself acts as nutrient source. This technique is simple and easy to perform.

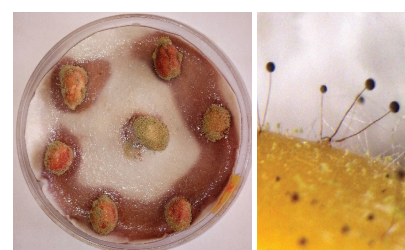

12. Study of plant diseases Agrios (1997) has defined plant disease as a series of invisible and visible responses of plant cells and tissue to a pathogenic microorganisms or environmental factors that result in adverse changes in the form, function or integrity of the plant and may lead to partial impairment or death of the plant or its parts. Plant diseases are caused by fungi, bacteria, mollicutes, protozoa, nematodes, viruses, viroids and angiospermic plant parasites. A plant disease is diagnosed with the help of signs and symptoms appearing on them due to infection.

13. Plant tissue culture Totipotency is the ability of a cell to divide and multiply. This property is well established in plant meristems. Under favourable nutrient and growth conditions each is capable of forming the tissue and organs. Such properties of plant meristematic cells are used to get callus (undifferentiated mass of cells), somatic embryoids and plantlets by growing the plant cells in vitro on suitable medium. Source material in plant tissue culture is called explant.

14. Plant cell suspension culture Plant cells grows in vitro in liquid medium under continuous agitation will be able to produce cells liberated and in clumps of few cells. These cells are capable for plant transformation or hybrid production or protoplast generation.

15. Plant cell viability testing

To determine cell viability using Trypan blue dye, exclusion test is used to determine the number of viable cells present in a cell suspension. It is based on the principle that live cells possess intact cell membranes that exclude certain dyes, such as trypan blue, Eosin or propidium, whereas dead cells do not. In this test, a cell suspension is simply mixed with dye and then visually examined to determine whether cells take up or exclude dye. In the protocol presented here, a viable cell will have a clear cytoplasm whereas a nonviable cell will have a blue cytoplasm.

16. Phytochemical analysis

To determine the presence of bioactive compounds, present in plant crude extracts. Phytochemical analysis refers to the extraction, screening and determination of the medicinally active substances found in plants. Some of the bioactive substances that can be derived from plants are flavonoids, alkaloids, carotenoids, tannin, antioxidants and phenolic compounds.

Zoology

17. Study of animal cells and tissues

To study different types of animal cells

a. Epithelial cells: Epithelium is composed of one or more layers of densely packed cells. In vertebrates, it lines the outer layer of the skin (epidermis), the surface of most body cavities, and the lumen of fluid-filled organs.

b. Connective Tissue: A tissue, usually of mesoblastic origin, that connects, supports, or surrounds other tissues, organs, etc.

18. Study of Barr body

To study Barr body in buccal cavity of female human beings. A Barr body is inactivated (heterochromatinised) X chromosome. It was first observed by Murray Barr in 1949. It is found only in female cells, in those 1 X chromosomes, which are enough for metabolic activity. It is absent in male somatic cells, because there only 1 X chromosome is present, which is in an active state.

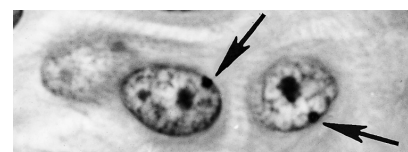

19. *Drosophila* culturing

Drosophila culturing medium is essentially a carbohydrate medium made of Wheat meal (rava), Jaggery, Agar agar, and Propionic acid with water and boiling it. Before transferring the flies, small amount of yeast is added. Both the adults and the larvae eat the yeast.

20. Study of *Drosophila* and mutants

Drosophila is a famous model system used to understand various aspects of life processes. A genus of small, two-winged flies accounts nearly 2500 described species. Discoveries in fruit flies have greatly contributed to our understanding in different aspects of biology. Mendel's genetic studies of the garden pea were the serendipitous consequence of his duties in the monastery garden. In contrast, *Drosophila* found to be a central organism in genetics as a result of careful consideration by Thomas Hunt Morgan at Columbia University in 1900, where he and his highly talented students AH Sturtevant, CB Bridges and HJ Muller were looking for a suitable species in which to perform studies of heredity.

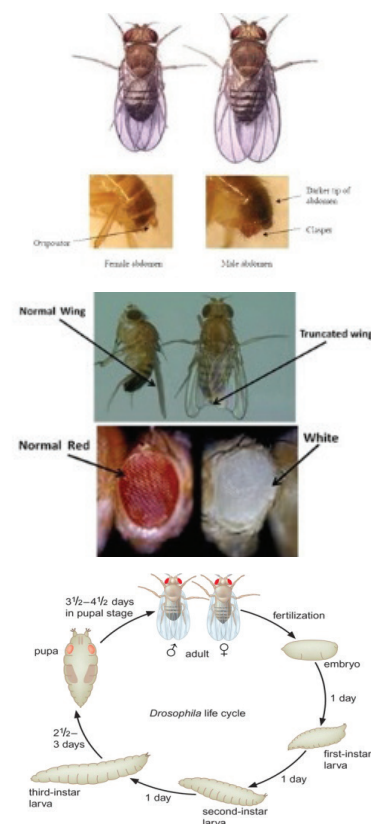

21. Study of protozoa

Protozoa are eukaryotic, generally unicellular life forms which lack cell wall and are motile at some stage of their life cycle. Protozoan members are free-living or parasitic in animals. They generally feed upon bacteria and other protozoans. There are some 65,000 species of protozoan members known till date; few of them such as *Entamoeba histolitica*, *Plasmodium* spp. and *Trypanosoma brucei* can cause serious human diseases. Some of the well-known protozoans are Amoeba, Paramecium, Euglena etc.

22. Total WBC count

Total white blood cell count is performed after diluting an aliquot of blood in WBC diluting fluid to lyse RBCs and stain WBCs. WBCs are counted microscopically in a haemocytometer with chambers of known volume. Since differential WBC count alone cannot reveal the true picture of infection, total WBC count is also taken into consideration.

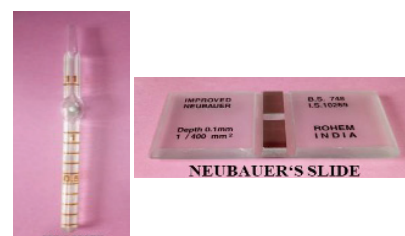

23. Differential WBC count

The white blood cell differential count determines the number of each type of white blood cell, present in the blood. It can be expressed as a percentage (relative number of each type of WBC in relationship to the total WBC) or as an absolute value is much more important than the relative value.

24. Blood cell count- haemocytometer

The hemocytometer (or haemocytometer or counting chamber) is a specimen slide which is used to determine the concentration of cells in a liquid sample. It is frequently used to determine the concentration of blood cells (hence the name "hemo-") but also the concentration of sperm cells in a sample. The cover glass, which is placed on the sample, does not simply float on the liquid, but is held in place at a specified height (usually 0.1 mm). In addition, a grid is etched into the glass of the hemocytometer. This grid, an arrangement of squares of different sizes, allows for an easy counting of cells. This way it is possible to determine the number of cells in a specified volume.

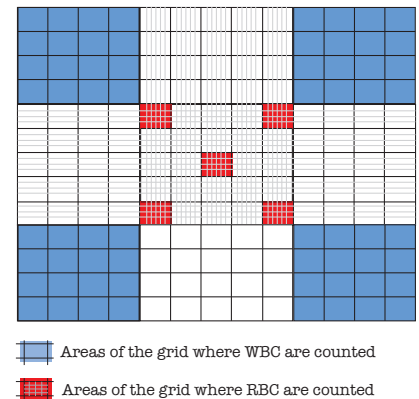

25. Determination of erythrocyte sedimentation rate

ESR is the rate at which erythrocytes in the anticoagulated blood sediment due to gravity when held in a vertical column. ESR is represented as fall of RBCs in mm per hour.

Normal ESR values are Male: 0–15 mm, Female: 0–20 mm and Children: 0–10 mm in one hour.



26. Haemoglobin estimation

Haemoglobin is a conjugated protein present in red blood cells. Haemoglobin consists of two components Haem (Iron + Protoporphyrin) and globin (amino acid chain). Haemoglobin is converted to acid haematin when treated with 0.1 N HCl. The brown colour of the resulting mixture is compared with the standard in Haemoglobinometer.

27. Study of bone marrow

To study the bone marrow. Bone marrow is a primary lymphoid organ. All blood cells get produced here by the process of hematopoietic stem cells are pluripotent. They have the capacity to divide continuously. Maturity of the cells will take place in different organs like thymus. Bone marrow extraction will provide useful information about the cellular components.

28. Study of thymus

The thymus is the site of T-cell development and maturation. It is a flat, bilobed organ situated above the heart. Each lobe is surrounded by a capsule and is divided into lobules, which are separated from each other by strands of connective tissue called trabeculae. Each lobule is organised into two compartments: the outer compartment, or cortex, is densely packed with immature T cells, called thymocytes, whereas the inner compartment, or medulla, is sparsely populated with thymocytes.

29. Study of spleen

The spleen plays a major role in mounting immune responses to antigens in the blood stream. It is a large, ovoid secondary lymphoid organ situated high in the left abdominal cavity. While lymph nodes are specialised for trapping antigen from local tissues, the spleen specialises in filtering blood and trapping blood-borne antigens; thus, it can respond to systemic infections. Spleen cells are used as source in monoclonal antibody production.

Microbiology**30. Microbiological tools**

The tools used in microbiology like Petri plates, Inoculation loop, needle and L-shaped rod and many other tools are introduced.

**31. Microscopy**

An introduction of different types of microscopes like Compound Microscope, dissecting microscope and stereo zoom binocular microscope will be done followed by hand on training how to use it. The compound microscope has two systems of lenses for greater magnification. The first one is the ocular or eyepiece lens (10 \times) that the observer looks into it and the second one is the objective lens, one closer to the object with different magnification power (4 \times , 10 \times , 40 \times and 100 \times), so that the total magnification power will be 1000 \times . Dissecting microscope is an optical microscope variant designed for low magnification observation of a sample, typically using light reflected from the surface of an object rather than transmitted through it. A stereo microscope is an optical microscope that functions at a low magnification. It works by using two separate optical paths. It is ideal for examining surfaces view of solid materials.

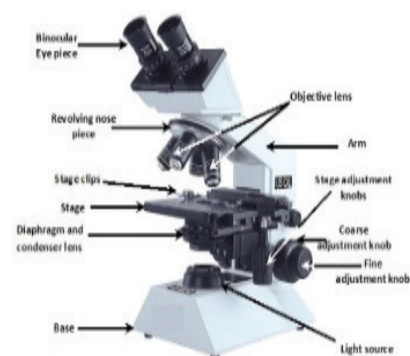

32. Microbiological sterilisation Methods

Different kinds of sterilisation process are explained. Sterilisation is a process of complete physical elimination or inactivation of all living cells in an environment. Sterilisation is achieved by exposing material to lethal agents like physical, chemical or ionic in nature. In case of liquids, physical elimination of cells from the medium is done. Selection of a method depends on the desired applicability, efficiency, toxicity, ease of use, availability, cost and effect on the properties of the object to be sterilised. The agents commonly used for sterilisation are heat (dry or moist heat), chemicals (alcohol, aldehydes), ultra-filters (0.2 or 0.45 μm syringe filter) and UV radiations.

33. Preparation of culture media

Microorganisms like all other living organisms, require basic nutrients for their sustenance of life and reproduction. The food material on which microorganisms are grown in a laboratory is known as Culture medium. Ingredients of a culture medium depend on the type of microorganism desired to be grown. Nutrient Agar media (NA) for isolation of bacteria and Potato Dextrose Agar (PDA) for fungi are generally used. Agar in a culture medium acts as solidifying agent. The medium without any solidifying agent is known as 'Liquid medium or Broth'.

34. Isolation of Microorganisms from Natural Sources

When the sample from natural sources like soil, pond water and leaves etc. are inoculated on to a nutrient medium, microorganisms present in the sample multiply rapidly and form distinct colony of their own. The media generally used are Nutrient Agar (NA) for isolation of bacteria and Potato Dextrose Agar (PDA) for fungi.



35. Study of Colony Characteristics of Bacteria

The cultural characteristics of an organism pertain to its macroscopic appearance on a medium. The colony morphology of an organism depends on type of media used and other growth conditions provided. Descriptive terms must be used in recording cultural characteristics.

36. Pure culture techniques

There are a number of procedures available for the isolation of pure cultures from mixed populations. Simpler methods for isolation of a pure culture include:

- (i) spread plating on solid agar medium with a glass spreader and
- (ii) streak plating with a loop.
- (iii) pour plate on solid media.

The purpose of spread plating and streak plating is to isolate individual bacterial cells (colony-forming units) on a nutrient medium.

Streak plate method:

For economy of materials and time, this method is best. It requires a certain amount of skill, however, which is forthcoming with experience. A properly executed streak plate will give as good isolation as is desired for most work. The important thing is to produce good spacing between colonies.

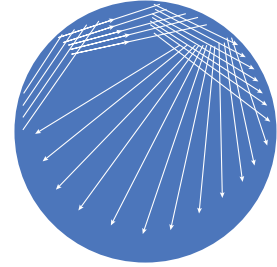

1. QUADRANT STREAK (Method A)

37. Preparation of Bacterial Smear

To study the size, shape, arrangement and structure of bacterial cells, they are first fixed on a glass slide and stained to make them more readily visible. A properly prepared bacterial smear is one which withstands one or more washings during staining without loss of organisms.

38. Simple staining

The use of single stain to colour bacteria is commonly referred to as simple staining. Some of the most commonly used dyes for simple staining are methylene blue, crystal violet and safranin. The purpose of simple staining technique is to study cell shape, size and the arrangement of bacterial cells.

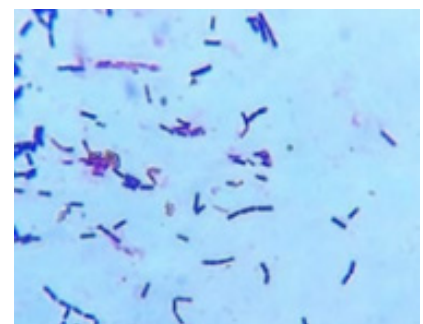

39. Negative staining

In negative staining technique a simple stain is used that does not stain the bacteria but stains the background. Nigrosine/India ink, an acidic stain carrying negative charge, is repelled by the bacteria which too carry a negative charge on their surface. Therefore, bacteria cell appears transparent and unstained upon examination. Negative staining provides information about the cell shape and arrangement.



-
- 40. Gram's staining** The difference in staining responses to the gram stain can be related to chemical and physical differences in bacterial cell wall. The gram-positive bacterial cell wall is thick and chemically simple composed mainly of protein and mucopeptides. When treated with alcohol, it causes dehydration and closer of cell wall pores, there by not allowing the loss of crystal violet-iodine complex and cells remain purple. In contrast, the gram-negative bacterial cell wall is thin, complex, multilayered structure and contains relatively a high lipid contents, in addition to protein and mucopeptides.
-
- 41. Capsular staining** Some bacteria have a gelatinous or mucilaginous covering external to the cell wall. This envelop is of different thickness depending on the bacterial species. Capsule is composed of polysaccharides, glycoproteins or a polypeptide. Capsule play an important role in determining the pathogenicity of the species. Consequently, capsulated forms are called virulent and non-capsulated forms are called avirulent. Capsule staining assist in the identification of pathogens in medical microbiology.
-
- 42. Flagella staining – Leifson's method** To study the structure of bacterial flagella, the motility of bacteria is brought about by long thread like structures called flagella. These are thin proteinaceous structures that originate from the cytoplasm and project out of the cell wall. In spite of their long length, they are extremely thin and can be seen only under electron microscope. In order to do this, a mordant is coated over the entire length of flagella to increase their apparent diameter and stained with a specific dye.
-
- 43. Endospore staining – Schaeffer-Fulton method** To stain bacterial endospores. In some of the bacteria, like Clostridium and Bacillus, endospores are produced. These are extremely resistant to heat, radiation, treatment of chemicals etc. This resistance is primarily due to a thick wall – the spore coat. The spore coat does not take the stain easily. Considerable amount of heating is required in order to make the stain to penetrate the spore coat. Once stained, the spore does not get decolourised easily. By this staining, position of the spore can also be noticed.

-
- 44. Acid fast staining** To detect acid fast bacilli in sputum samples. The acid-fast stain is a differential stain that measures the resistance of a microbial cell to decolorising acidic agents. This measures the property of acid fastness by bacteria. It is used for the identification of *Mycobacterium tuberculosis* and *M. leprae*. In this staining procedure bacteria are classified into acid fast if they retain the primary stain (carbol fuchsin) after washing with acid. Non-acid-fast bacteria retain the counter stain methylene blue. The property of acid fastness is correlated with high lipid (mycellic acid) content in the cell wall.
-
- 45. Albert staining** To stain the metagranules in bacteria by Albert staining. Albert stain is a type of differential stain used for staining the volutin granules also known as metachromatic granules or food granules found in *Corynebacterium diphtheriae*. It is named as metachromatic because of its property of changing colour i.e. when stained with blue stain they appear red in colour. When grown in Loeffler's slopes, *C. diphtheriae* produces large number of granules.
-
- 46. Isolation of *Rhizobium*** *Rhizobium* is a gram-negative bacterium. It forms a symbiotic association with the legumes which results in the formation of root nodules that fixes the atmosphere nitrogen. Successful nodulation of leguminous crop by *Rhizobium* largely depends on the availability of a compatible strain for a particular legume. Structurally *Rhizobium* are rod shaped but great variation can be observed during their life cycle. These are coccoid, very small, highly motile and ellipsoidal forms. The bacteroides are usually irregular with X, Y, star and club-shaped forms.
-
- 47. IMViC test**
- a. Indole test:** To test the ability of the bacteria to utilise tryptophan to produce indole. This test demonstrates the ability of certain bacteria to decompose the amino acid tryptophan to indole, which accumulates in the medium. Indole is then tested by colorimetric reaction with p-dimethylaminobenzaldehyde resulting in pinkish red colour.
- b. Methyl red test:** Bacteria produce large amount of lactic, acetic, succinic and formic acids when they ferment sugar. The accumulation of these acids results in lowering of pH of the medium to 5.0 or less. When methyl red is added to the cultures, it

turns red, suggesting that the organism to be mixed in an acid fermenter .

c. Voges-Proskauer test: Bacteria may utilise sugar and produce 2,3-butanediol and ethanol instead of acids. The presence of butanediol in the culture broth cannot be directly tested. However, acetoin (acetyl methyl carbinol), a precursor of butanediol is easily detected with Barritt's reagent.

d. Citrate utilisation test: In the absence of fermentable sugars some bacteria are capable of using citrate as a carbon source due to their ability to produce citrate permeases and citrase. This is the test for the ability of an organism to utilise citrate as the sole carbon and energy source for growth. Cimmon's citrate agar medium is used. The colour change from green to blue is due to change in the medium from acidic pH to alkaline pH.

48. Triple sugar iron agar (TSIA) test

To test the ability of the bacteria to ferment sugar and produce H_2S . This is a combined test for ability of bacteria to ferment sugar and H_2S production. The ability of bacteria to ferment different sugars can be checked by observing change in colour of the medium due to acid production. Sodium thiosulphate present in the medium acts as a substrate for H_2S production. This H_2S reacts with iron present in the medium giving black precipitate.

49. Bacterial catalase test

To determine catalase activity in bacteria. Most aerobes and facultative anaerobes utilise oxygen for respiration and produce hydrogen peroxide as a metabolic product. The hydrogen peroxide produced is toxic to the cells and hence production of H_2O_2 becomes suicidal. Bacteria have evolved a mechanism of getting rid-off H_2O_2 produced in the cell. The bacteria produce an enzyme called 'Catalase' to breakdown H_2O_2 into water and oxygen. The release of oxygen is indicated by effervescence.

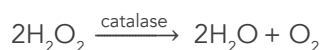

50. Bacterial motility-hanging drop technique

To determine motility of bacteria by hanging drop technique. Hanging drop preparation is useful for microscopic examination of living microorganisms to study their motility. Organisms are observed in a drop that is suspended under a cover glass in a cavity slide. Since the drop lies within an enclosed glass chamber, drying occurs very slowly.

51. Slide culture: autotrophs

To make comparative studies of free-living organisms in freshwater lakes, A. T. Henrici (1932), devised an immersed slide technique that revealed the presence of many organisms. The technique worked well for algae, bacteria and other microorganisms. Method consists of suspending glass microscope slides in the body of water for a specified period of time. Microorganisms in the water adhere to the glass and multiply to form small colonies that are observable under the microscope.

52. Study of cyanobacteria and algae

Cyanobacteria and algae are groups of microscopic unicellular or multicellular organisms which are present abundantly in most of the aquatic ecosystems. They consist of photosynthetic pigments and produce their own food. Algae are eukaryotic organisms that have distinct, visible nuclei and chloroplasts. The undifferentiated algal structure is referred as a Thallus. Although referred as blue green algae, cyanobacteria are prokaryotic microbes. Cyanobacteria are gram negative bacteria consisting of photosynthetic pigments in granules that are attached to the membrane.

53. Microscopic observations of fungi by tease mount preparation

Fungi are generally microscopic and transparent which makes them difficult to observe. In this technique, fungi are stained using cotton blue stain and mounted in lactophenol to obtain semipermanent microscopic slides. Many of the fungi are themselves coloured known as 'Dematiaceous fungi', which can be mounted using lactophenol solution and observed using a microscope without staining. The tease mount preparation provides a chance for different conidia and hyphae to be observed.

54. Study of fungi

Fungi are eukaryotic microorganisms without plastids. Fungi are unicellular or filamentous consisting of multicellular haploid hyphae with absorptive nutrition. Their cell wall is made up of chitin or β -glucans. The estimated number of fungi is 1.5 million among which only 70,000 species are known till date. Fungi are morphologically diverse group of organisms. Some of the well-known species of filamentous fungi are *Aspergillus* spp., *Penicillium* spp., *Rhizopus* spp., *Alternaria* spp., *Curvularia* spp. and *Drechslera* spp. Fungi also exist in unicellular form commonly known as 'Yeasts'. Fungi are economically important as they are the source of food, medicine and industrial products.

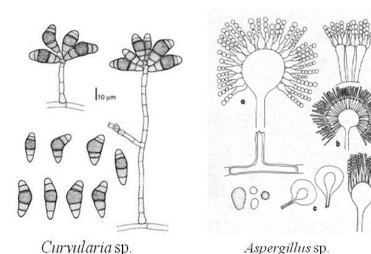

55. Study of lichens

Lichen is the term used to describe symbiotic, mutualistic interaction between fungus and algae/cyanobacteria. They grow on rocks and tree barks. The colour of lichens may vary from white to black through red orange yellow and green. Morphologically, lichens are made up of an algal layer sandwiched between two fungal layers. Not all but only single species of compatible fungus and algae can enter into lichenlike relationship. About 18,000 species of lichens are known till date. There are basically three kinds of lichens: 'Crustose lichen' which is flat and appressed, 'Foliose lichen' which appears leaf like, slightly raised from the surface and 'Fruticose lichen' which is shrub like. Commercially important products from lichens are essential oils used in perfume making and pigments like litmus.

56. Bacterial growth assessment

Bacterial growth in broth increases the turbidity due to increase in number of individuals. Turbidity can be measured by colorimeter. Growth is obtained by plotting a graph of turbidity against time. Four phases of bacterial growth are lag phase, exponential phase, stationary phase, death phase.

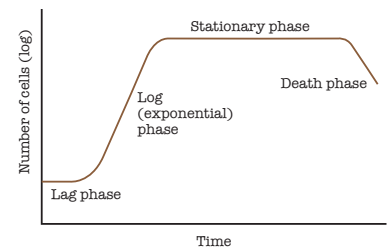
**57. Micrometry**

To determine size of microscopic organisms by Micrometry. Micrometry refers to the measurement of microorganisms (length and breadth) seen under light microscope. The distance between the lines of an ocular micrometer is an arbitrary value that only has meaning if the ocular micrometer is calibrated for the objective that is being used. A stage micrometer, also known as an objective micrometer has lines scribed on it that are exactly 0.01 mm (10 micrometer) apart. To calibrate the ocular micrometer for a given objective, it is necessary to superimpose the two scales and determine how many of the ocular graduations coincide with one graduation on the scale of the stage micrometer.

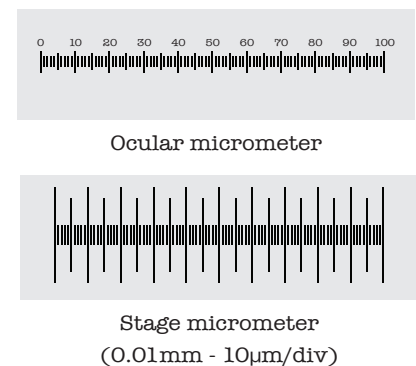
**58. Effectiveness of hand scrubbing on microbial load**

Human skin harbours various microorganisms. Some pathogenic microorganisms may also persist and transmit through contaminated hands. Various methods like washing with water and soap, swabbing with alcohol are practiced. Scrubbing the hands involves the physical removal of microbes. Depending on the condition of the skin and number of microorganisms present, it takes seven to eight minutes of washing with soap and water to remove maximum surface microorganisms and they can be killed using suitable antiseptics such as 70% alcohol or Dettol.

59. Determination of susceptibility to dental caries

Dental caries commonly known as tooth decay. A variety of microorganisms are known to be involved in formation of dental caries. This test measures the amount of acid produced by the bacteria. The test employs a differential medium, Snyder agar (pH 4.7), which contains glucose as carbon source and bromocresol green as pH indicator which gives green colour to the medium. Upon acid production by microbes, the pH of the medium tends to lower from 4.7 to 3.8 and below. At this pH, the green colour of the medium changes to yellow. The sample demonstrating yellow colour within 24-48 hrs is suggestive of the host susceptibility to formation of dental caries.

60. Antibiotic sensitivity test

a. Disc diffusion method: Antibacterial agents are chemicals that can kill or inhibit the growth of bacteria termed as bactericidal or bacteriostatic compounds respectively. When the discs impregnated with antibacterial agents come in close contact with the medium, they get diffused into the medium thus inhibiting the growth of bacteria. The effectiveness of an antibiotic in this method is based on size of zone of inhibition. The method was originally standardised by WMM Kirby and AW Bauer in the year 1969, so the method is also known as Kirby-Bauer method.

b. Antimicrobial activity test (Agar well diffusion method): To detect the antimicrobial activity of different natural extract. Antimicrobial agents are some of the most widely, and often injudiciously, used as a therapeutic drug worldwide.

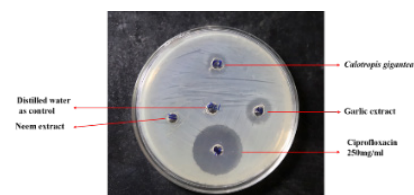

61. Milk Test

There are different methods for milk testing like **Organoleptic** tests, clot on boiling test, alcohol test and turbidity test to determine the quality of the milk.

62. Microscopic examination of pond water

To observe microscopic phytoplanktons and zooplanktons in pond water. Pond is an important aquatic ecosystem consisting of various microorganisms such as bacteria, fungi, algae and protozoa. Microscopic examination of a drop of pond water through wet mount preparation provides considerable amount of information on diversity of microorganisms based on their shape, colour and motility.

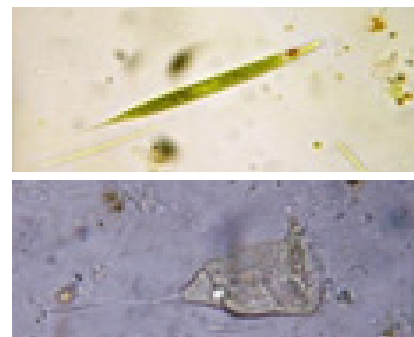

Biochemistry

-
- | | |
|--|---|
| 63. Buffers, buffers action and titration | To prepare different types of buffers and study the buffer action by doing titration against acid and base. |
|--|---|
-
- | | |
|------------------------------|---|
| 64. Starch hydrolysis | To determine amylase activity by starch hydrolysis. Starch is polysaccharide made up of inter linked, long chains of glucose units. Amylase is an enzyme which hydrolyses starch into maltose and glucose units. Conversion of starch into maltose and glucose can be tested by Benedict's test as starch is a non-reducing sugar whereas both maltose and glucose are reducing sugars. |
|------------------------------|---|
-
- | | |
|--|--|
| 65. Determination of amylase activity | To detect salivary amylase activity. Every enzyme has maximum activity at optimum temperature and pH. This is unique to every enzyme. Optimum condition for amylase enzyme is pH - 7.0 and temperature is around 37° C. Conversion of starch into maltose and glucose can be tested by Benedict's test as starch is a non-reducing sugar whereas both maltose and glucose are reducing sugars. |
|--|--|
-
- | | |
|---|---|
| 66. Qualitative analysis for carbohydrates | Carbohydrates prevail widely in nature comprising mono, di, oligo and polysaccharides. Most commonly occurring monosaccharides are glucose, fructose, galactose and ribose. The combination of two monosaccharide units gives rise to disaccharides, for example sucrose, lactose and maltose. Starch, cellulose and pectin are polysaccharides made up of many monosaccharide units. Aldehyde (- CHO) and ketone (= CO) are the active groups in carbohydrates. Carbohydrates contain many hydroxyl groups as well. The chemical property of carbohydrates depends on number of hydroxyl groups, presence of - CHO / = CO group and various acid residues as side chains. These variations are the basis in the development of colour reactions to identify different carbohydrates. |
|---|---|
-
- | | |
|--|--|
| 67. Quantitative analysis of reducing sugar by dinitrosalicylic acid (DNS) method | To estimate the reducing sugar (Glucose) by DNS method. 3, 5 - dinitrosalicylic acid, compound is commonly used to estimate the concentration of reducing sugars. The compound is yellow in alkaline condition, which is reduced to 3 amino 5 nitrosalicylic acid when combines with reducing sugar, to give orange red colour. By plotting a standard graph of known concentration of glucose solution vs absorbance at 520nm the unknown sample concentration can be obtained from the standard curve. |
|--|--|

68. Qualitative analysis for proteins

To analyse the given sample for presence of proteins. Proteins are present in the living world, irrespective of the size of the organism, since they form the structural and functional basis of a cell. Proteins are made up of amino acid residues joined by peptide bonds. Proteins react with variety of reagents to form coloured products as they contain peptide bonds. Egg albumin is a glycoprotein soluble in water. Casein is a phosphoprotein present in milk with phosphate group attached to -OH group of serine or threonine residues. Peptone is a source of nutrition for microorganisms made up of short chain of amino acids. Gelatin is also a protein which is used as solidifying agent.

69. Quantitative estimation of proteins by Folin – Lowry method

To quantify amount of protein present in the given sample. Protein reacts with the Folin-Ciocalteu reagent to give a coloured complex. The colour so formed is due to the reaction of the alkaline copper with the protein as in the biuret test and the reduction of phosphomolybdate by tyrosine and tryptophan present in the protein. The intensity of colour depends on the amount of these aromatic amino acids present and will thus vary for different proteins. By plotting a standard graph of known concentration of a known protein (BSA) solution vs absorbance at 660 nm the unknown protein sample concentration can be obtained from the standard curve.

70. Qualitative analysis of lipids

To analyse lipids contents in the given sample by performing solubility test, transparency test, emulsification test, test for unsaturation, test for cholesterol and test for free fatty acid.

71. Analysis of urine constituents

To analyse urine samples for different components. The quantity and composition of urine reflects various biochemical processes that occur in the body. The composition of the urine of an individual may change when a person has a disease. In a diseased condition, it is quite common to observe the presence of abnormal constituents or normal constituents in abnormal quantities in the urine.

72. Enzyme assay: invertase

To detect the Invertase activity in yeast cells. Our most common food sugar – the disaccharide, sucrose – is formed in all green plants. The metabolism of sucrose in the animal body begins with the action of invertase (sucrose) which hydrolyses the disaccharide to two monosaccharides, fructose and glucose. This same enzyme is also produced by plants and fungi.

73. Determination of protease activity

To determine protease activity from plant source. Papain from latex of papaya and bromelain from the pineapple, are best protease enzymes from plant source. Hydrolysis of protein takes place through protease enzyme. Easily accessible source of enzyme is from fresh pineapple. Gelatin may be used as substrate for protease. Gelatin is solid below 25°C and gets liquefied at higher temperature.

74. The ultraviolet absorption of proteins and amino acids

To determine absorption spectra of protein and amino acid. Many compounds have characteristic absorption spectra in the ultraviolet and the visible regions so that identification of these materials in a mixture is possible. Proteins absorb strongly at 280 nm according to their content of the amino acids – tyrosine and tryptophan, and this provides a sensitive and non-destructive form of assay. Proteins also absorb in the far ultra violet because of the peptide bond.

Immunology

75. Pregnancy detection

To detect HCG in urine samples. Human chorionic gonadotrophin (hCG) is the hormone produced exclusively in pregnant women after 24 hours of conceiving, The presence of low level of hormone in urine can be detected by sensitive immunochromatography technique. This test indicates the presence of HCG in urine based on antigen-antibody reaction and thus detects pregnancy.

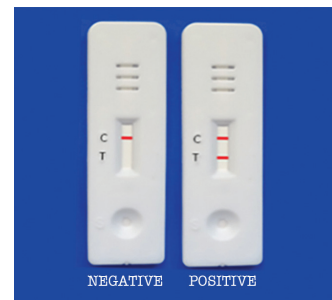

76. Blood group determination

Principle: The procedure for blood typing was developed by Carl Landsteiner (1900). The human blood types can be separated into four basic groups on the basis of two antigens that are present on the red blood cells. These antigens are designated as 'A' and 'B'. ABO typing of blood is based on the principal of agglutination, a type of reaction that occurs between particulate antigen and specific antibodies that leads to clumping of red blood cells. The presence of another antigen on RBC's of human blood, designated as Rh factor (antigen found in rhesus monkey) was reported by Landsteiner and Wiener in 1940. The presence of Rh factor is also demonstrated by agglutination reaction. The presence of Rh factor in blood is characterised as 'Positive' and the absence of which is termed as 'Negative'.

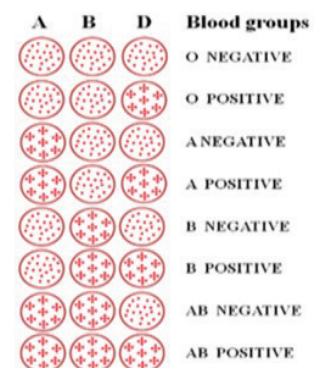

77. VDRL test (RPR)

To diagnose Syphilis by VDRL test. This Diagnostic reagent kit is used for detection of antibodies produced in mankind in response to the stimulation by disease known as syphilis caused by *Treponema pallidum*. RPR test is a modified version of Wassermann's reaction in which the antigens coated with carbon particle are allowed to react with the sample and if the antibodies for syphilis are present the flocculation will occur on the slide due to aggregation of carbon particle, if the sample does not contain the antibody then carbon particle will aggregate in the centre of slide to give an appearance of button which indicates negative reaction.

78. WIDAL test

This experiment is to detect typhoid infection by WIDAL test.

Typhoid fever is an acute infectious disease characterised by definite lesions in Peyer's patches, mesenteric glands and spleen accompanied by fever, headache and abdominal symptoms. It is also called 'enteric' fever. The causative organism of the typhoid fever is a gram-negative bacillus, *Salmonella*. The detection of these antibodies in suspected patients forms the basis of the 'Widal' test. The antigens used in Widal kit are standardised, smooth suspensions of killed bacilli, which are stained for their easy identification in agglutination reactions. Two test procedures are employed. The rapid slide agglutination test is done as screening test to establish the presence or absence of a homologous antibody and a confirmatory test is done by test tube procedure.

79. Ouchterlony's double diffusion test

To detect antigen-antibody reaction by Ouchterlony test. This test is performed by pouring molten agar onto glass slides or into Petri dishes and allowing it to harden. Small wells are punched out of the agar, a few millimetres apart. Samples containing antigen and antibody are placed in opposing wells and allowed to diffuse toward one another in a moist chamber for 18–24 hours. Antigen and antibody diffuse out of the wells in a radial manner. Gels can be dehydrated and stained by protein binding dyes like Coomassie Brilliant Blue and preserved indefinitely.

80. Immuno-precipitation

The classical precipitation reaction was first demonstrated by immunodiffusion in gel. It detects the reaction between soluble antigen and a potent antiserum mixed in the correct proportions. The antigen-antibody precipitate that is so formed in any semi solid medium such as agar or agarose is also dependent on buffer electrolytes, pH and temperature. The formation of precipitation lines in any immunodiffusion system is highly dependent on relative concentrations of antigen and antibody.

81. Enzyme linked immunosorbent assay (ELISA)

Enzyme linked immunosorbent assay or ELISA is a sensitive immunological technique to detect the presence of a specific antigen (Ag) or antibody (Ab) in a biological sample. It utilises the dual properties of antibody molecules being specific in reactivity and their ability to be conjugated to active molecules such as enzymes. ELISA is extensively used for diagnostic purpose which utilises the dual. It requires an immobilised antigen/antibody bound to a solid support (e.g. microtiter plate or membrane). There are different types of ELISAs for the detection of a protein of interest in a given sample. One of the most sensitive ELISA is Antigen Capture ELISA which can measure the concentration of antigen.

82. Western blotting

Western blotting or protein immunoblotting is a very sensitive and analytical method that involves detection of a specific protein in a complex mixture. Protein samples are first separated using SDS-Polyacrylamide gel electrophoresis (SDS-PAGE) followed by the immobilisation of proteins on nitrocellulose or PVDF membranes. The transfer of proteins from the gel to the membrane is done electrophoretically. The transferred protein is detected using specific primary antibody and secondary enzyme-labelled antibody and substrate. This method utilises the principle of antigen-antibody interaction for identification of specific antigens by monoclonal or polyclonal antibodies.

Molecular Biology and Genetic Engineering

83. Isolation of genomic DNA from bacteria

Most commonly used protocols for the isolation of bacterial genomic DNA consist of lysozyme / detergent lysis, followed by incubation with a non-specific protease, and a series of phenol / chloroform / isoamyl alcohol extraction's prior to alcohol precipitation of the nucleic acids. In this procedure, the protease incubation is followed by a CTAB extraction whereby TxA₂ complexes both with polysaccharides and with residual protein; both groups of contaminating molecules are effectively removed in the subsequent emulsification and extraction with chloroform/isoamyl alcohol. The method can also be used to extract high-molecular weight DNA from bacteria.

84. Isolation of DNA from plant

To isolate DNA from different plant samples by Phenol – Chloroform method. Plant cells are surrounded by cell wall. Treatment with detergent (Sodium dodecyl sulfate, SDS) is an effective way of break opening the cells and their nuclei to release the content. For this, lysis buffer containing Tris, EDTA and SDS is used. The DNA is associated with a number of proteins. These can be removed by adding phenol-chloroform and isoamyl alcohol. The phenol is removed by washing the DNA with chloroform. Finally, cold ethanol precipitates out the crude DNA. Saline sodium citrate (SSC) buffer is used to dissolve DNA.

85. Blood genomic DNA extraction

To isolate genomic DNA from whole blood. Blood is a specialised body fluid composed of cells suspended in a liquid called blood plasma. Whole blood contains Red blood cells (RBCs), White blood cells (WBCs) and Platelets. Red blood cells (RBCs) do not have any DNA, as they lose their nuclei during maturation. The white blood cell (WBC) component of the blood contains the DNA. The blood sample is treated with detergents, which break open the cell membrane to release the contents. Enzymes are then used to break down all the proteins, RNA, sugars and fats in the solution.

86. Plasmid DNA isolation (Alkaline lysis method)

Plasmids are circular, double stranded DNA capable of replicating independently in bacteria and yeast. Variable sizes of plasmids are available in bacterial cells. These plasmids are useful vectors in genetic engineering. Isolation of plasmid is an important step in recombinant DNA technology.

87. The isolation of RNA from yeast

Total yeast RNA is obtained by extracting a whole cell homogenate with phenol. The concentrated solution of phenol disrupts hydrogen bonding in the macromolecules, causing denaturation of the protein. The turbid suspension centrifuged and two phases appear: the lower phenol phase contains carbohydrate and RNA. Denatured protein, which is present in the both phases, is removed by centrifugation. The RNA is then precipitated with alcohol. The product obtained is free of DNA but usually contaminated with polysaccharide. Further purification can be made by treating the preparation with amylase.

88. Restriction digestion of DNA

Restriction enzymes are enzymes isolated from bacteria that recognise specific sequences in DNA and cleave double-stranded DNA (dsDNA) at specific sites to produce fragments, called restriction fragments. Restriction enzymes are Nucleases which can cleave the sugar-phosphate backbone of DNA. As they cut within the molecule, they are commonly called 'endonucleases'. Restriction enzymes are found naturally in bacteria. Each restriction enzyme has specific requirements to achieve optimal activity. Conditions such as temperature, pH, enzyme cofactor(s), salt composition and ionic strength affect enzyme activity and stability. Restriction endonucleases recognise palindromic sequences. In other words, palindromic sequences are complimentary strands that read the same in opposite direction.



89. Ligation of DNA fragments

The joining of DNA fragments by ligase enzymes. Construction of DNA molecule is dependent on the ability to covalently seal single stranded nicks in DNA. This process is accomplished both in vivo and in vitro by the enzyme DNA ligase. It catalyses the formation of phosphodiester bonds between juxtaposed 5' phosphate and 3' hydroxyl terminus of double stranded DNA and join double stranded DNA restriction fragments having either blunt ends or homologous cohesive ends. *E. coli* ligase and T4 DNA are the two DNA ligases used in nucleic acid research.

90. Agarose gel electrophoresis

Separation of DNA fragments by agarose gel electrophoresis. Electrophoresis is a technique used to separate charged molecules. DNA is negatively charged at neutral pH. When electric field is applied across the gel, DNA migrates towards the anode. Migration of DNA through the gel is dependent upon Molecular size of DNA, Agarose concentration, Conformation of DNA, Applied current. To visualisation of DNA fragments an intercalating dye Ethidium bromide is added in agarose gel during preparation. After electrophoresis, the gel is removed from the tank and placed on a UV-transilluminator to observe fluorescing DNA bands.

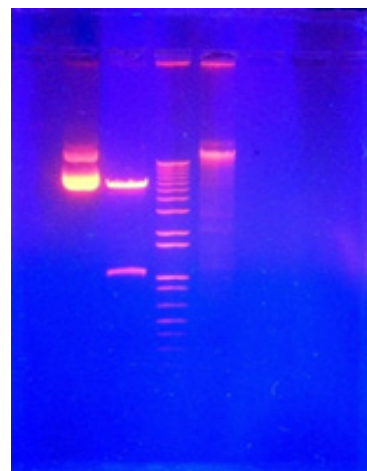
**91. The estimation of DNA by the Diphenylamine method**

When DNA is treated with diphenylamine under acid conditions, a blue compound is formed with a sharp absorption maximum at 595nm. This reaction is given by 2-Deoxypentoses in general and is not specific for DNA. In acid solution, the straight chain form of a deoxypentose is converted to the highly reactive β -hydroxy levulinialdehyde, which reacts with diphenylamine to give a blue complex. In DNA, only the deoxyribose of the purine nucleotides reacts, so that the value obtained represents half of the total deoxyribose present.

92. Estimation of RNA by Orcinol method

To estimate the amount of RNA present in a sample. This is a general reaction for pentoses and depends on the formation of furfural when the pentose is heated with concentrated hydrochloric acid. Orcinol reacts with the furfural in the presence of ferric chloride as a catalyst to give a green colour. Only the purine nucleotides give any significant reaction.

93. SDS page for proteins

To separate proteins by SDS electrophoresis. Electrophoresis is defined as the separation (migration) of charged particles through a solution or gel, under the influence of an electric field. The rate of movement of particle depends on the charge of the particle, applied electric field, temperature, nature of the suspended medium. Gel electrophoresis is a method that separates macromolecules either nucleic acids or proteins on the basis of size, electric charge and other physical properties. SDS provides a negative charge to the protein so under the influence of current it migrates towards positive charged electrode.

94. Spectroscopic analysis of DNA

Determination of concentration of isolated DNA samples by UV spectrometer.

Concentration of DNA sample ($\mu\text{g/ml}$) =
 $50 \times A_{260} \times \text{dilution factor}$

95. Polymerase chain reaction (PCR)

Amplify a specific DNA fragment by polymerase Chain Reaction. Polymerase Chain Reaction (PCR) is an in vitro method of enzymatic synthesis of specific DNA fragment developed by Kary Mullis in 1983. It is a very simple technique for characterising, analysing and synthesising DNA from virtually any living organism (plant, animal, virus, bacteria). PCR is used to amplify a precise fragment of DNA from a complex mixture of starting material called as template DNA.

96. Bacterial transformation

Bacterial transformation is a process which involves genetic alteration of bacteria by incorporation and stable expression of a foreign genetic material from the environment or surrounding medium. Since DNA is a very hydrophobic molecule, it will not normally pass through a bacterial cell membrane. In order to uptake the foreign DNA, the bacterial cells must first be made competent. Competence is the ability of a cell to take up extracellular DNA from its environment. There are different methods of carrying out transformation, e.g. chemical transformation, electroporation, gene gun, liposome mediated transfer and microinjection. Chemical transformation includes the usage of Calcium chloride (CaCl_2). This mode of transformation is easy to perform and requires minimum number of equipment.

97. Isolation of bacteriophages

Bacteriophages are viruses infecting bacteria. The presence of bacteriophage in the natural environment will be relatively lower and therefore it is essential to use desired host bacteria along with the nutrients as an enrichment technique. After incubation the bacteriophages can be separated by centrifugation and then by membrane filtration. The filtration by using bacterial filters has been used to physically remove the bacteria from the liquid. The final step is to produce plaque by seeding a lawn of bacteria with the phage in the filtrate.

98. Gene cloning, expression, purification and characterisation

The protocol includes amplification of DNA by PCR (polymerase chain reaction) followed by Gel elution, DNA ligation, Bacterial transformation, Plasmid DNA isolation, Restriction digestion, Estimation of DNA concentration using UV-visible spectrometer, Protein expression, Purification, Characterisation by SDS-PAGE and Western blotting.

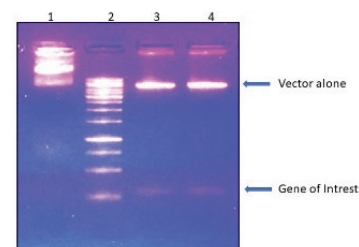

Lane-1:- Before Digestion, Lane-2:- 1 kb Marker, Lane-3 & 4 :- Digested sample; vector alone & insert

Biotechnology and Bioinformatics

99. Cell immobilisation

To demonstrate immobilisation of yeast cells. Immobilisation is a technique in which the cells are retained in a restricted space or surface of certain matrices but retain their catalytic activity. The methods available for immobilisation are classified into two broad types. Attachment on the insoluble support and Entrapment in matrix. Because of the large size of the cells, entrapment is a widely used technique. Whole cells can be immobilised by entrapping them in spheres of alginate gel. This technique is commonly used in industry, and does not impair cell activity.

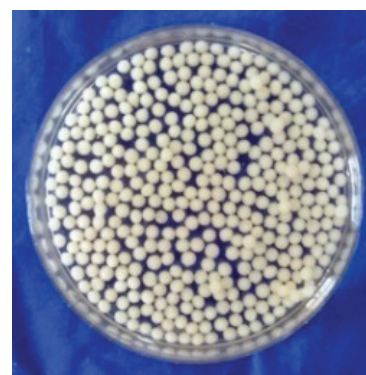

100. Biofertilizers

Biofertilizers are the substances which make use of the microorganisms to fertile the soil. They are many types and each type take care of the amount of nitrogen and phosphorus level in the soil. The microorganisms are known to interact with plants in different ways. Plant health parameters are always considered under the environmental conditions favouring the plant growth.

101. Alcohol fermentation by yeast

The yeast *Saccharomyces cerevisiae* converts the fermentable sugars (Glucose, fructose and sucrose) into ethanol and CO_2 . In the large-scale production of alcohol, molasses is used as the substrate for yeast fermentation molasses, a byproduct in the sugar refinery industries, contains about 45%–55% (w/v) of fermentable sugar as sucrose. Sucrose is metabolised by yeast through Embden-Meyerhof pathway (EMP) and alcohol and CO_2 are the products of the fermentation.

102. Beer-Lambert's law

Beer's law: When a ray of monochromatic light passes through an absorbing medium its intensity decreases exponentially as the concentration of the absorbing medium increases.

Lambert's law: When a ray of monochromatic light passes through an absorbing medium its intensity decreases exponentially as the length of the absorbing medium increases. Hence, in a colorimeter/ spectrophotometer the absorbance of compound is dependent on concentration.

103. Urine analysis – Strip method

To detect the presence of sugar or protein in the urine. Normal urine contains only traces of protein. When it is found in urine, usually albumin predominates. Bence-Jones protein, haemoglobin are the significant non-albumin proteins under certain conditions. Minimal proteinuria (less than 0.5 g/day) is found following exercise or in highly concentrated urine. Fever, severe emotional or thermal stress, hypertension and lower urinary tract infection can also cause excretion of small quantities of protein. Sugar normally is not found in urine. But when blood sugar level rise well above a target range which can occur in type 1 and type 2 diabetes, the kidneys sometimes releases sugar into the urine even when blood sugar levels are within a range.

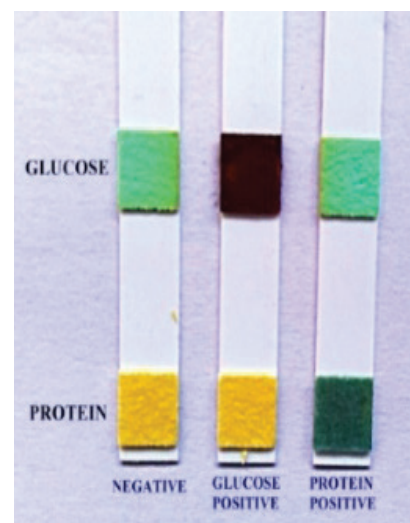
**104. Food analysis**

To determine the adulteration in food samples. Food adulteration is common problem in the food market. Various hazardous chemicals/materials are adulterated into food products. This not only causes health problems but also responsible for economic loss for the consumers. Hence, food analysis is essential to detect some of the adulterants.

105. Vitamin estimation

To estimate the amount of Vitamin A (retinol) and Vitamin B2 (riboflavin) in the given sample will be done. Vitamin A is a fat-soluble vitamin. The vitamin A is supplied to the body in the form of its precursor, β -carotene. A rapid and colorimetric method to measure vitamin A is described here is the blue colour produced by vitamin A and its palmitate with trichloroacetic acid (TCA) is proportional to its concentration, which is measured at 620nm. Vitamin B2 is water-soluble and photosensitive. Riboflavin fluorescence at wavelength 440–500 nm. The intensity of fluorescence is proportional to the concentration of riboflavin in dilute solutions.

106. Bioinformatics

The use of the computational techniques for solving biological problems. It is also called computational biology. Due to the advanced in the molecular biology a large amount of sequence and structural information generated. Using bioinformatics, researchers / scientists try to understand and answer some basic questions in biology.

Ecology

- 107. Ammonification in soil** The nitrogen in most plants and animals exists in the form of protein. When animals and plant die, the protein is broken down to amino acids, which in turn are deaminated to liberate ammonia. The process of production of ammonia from organic compounds is called ammonification. In this experiment, peptone broth inoculated with a sample of soil, incubated for few days and tested for ammonia formation. The presence of ammonia is detected by the formation of brown coloured precipitate after addition of Nessler's reagent.
-
- 108. Determination of Biological Oxygen Demand (BOD) of water** BOD is the index of water pollution. For measuring BOD, water samples are incubated at 20°C for 5 days in dark under aerobic condition, whereas the same can be incubated at 27°C for 3 days in tropical and subtropical regions where metabolic activities are higher. Oxygen also consumed during nitrification, therefore, 1ml of 0.05% alkylthiourea should be added to water sample to check over estimation of BOD.
-
- 109. Chemical Oxygen Demand (COD) of water** COD refers to the oxygen consumed by the oxidisable organic substances. The chemical oxidants such as potassium dichromate ($K_2Cr_2O_7$) or potassium permanganate ($KMnO_4$) are used to measure the oxidisability of the organic matter of water, where the oxidants oxidise the constituents (or the hydrogen but not nitrogen). Then potassium iodide (KI) is added. The excess amount of oxygen reacts with KI and liberates iodine. The excess amount of oxygen liberates equal amount of iodine. By using starch indicator, iodine is treated with sodium thiosulfate and amount estimated.
-
- 110. Determination of dissolved oxygen of water** Dissolved oxygen is measured by titrimetric method. The theory behind this method is that the dissolved oxygen combines with manganese hydroxide which in turn liberates iodine (equivalent to that of oxygen fixed) After acidification with H_2SO_4 . The iodine can be titrated with sodium thiosulfate solution by using starch indicator.
-
- 111. Detection of chlorine in water** The portable water is chlorinated to make the water free from microorganisms. However, some times the concentration of chloride ions in water is increased than what is normally required. Apart from this water also receives chloride ions from multifarious sources. The chloride ions (Cl^-) can be estimated by titrating with silver nitrate solution.

112. Determination of total alkalinity of water

Generally, pH of water remains neutral. Alkalinity of water represents the presence of hydroxyl ions (OH⁻) in water, hence, it is capacity of water to neutralise a strong acid. In neutral or waste water alkalinity is due to the presence of free hydroxyl ions which cause through hydrolysis of salts by weak acids and strong bases (e.g. carbonate and bicarbonates).

113. Bacteriological examination of water: MPN test

The most probable number (MPN) is an indirect count technique relying on statistical interpretation on growth (gas) or no growth (no gas) observation in the inoculated tubes. The step conducted in three steps such as presumptive test.

